

3D acquisition

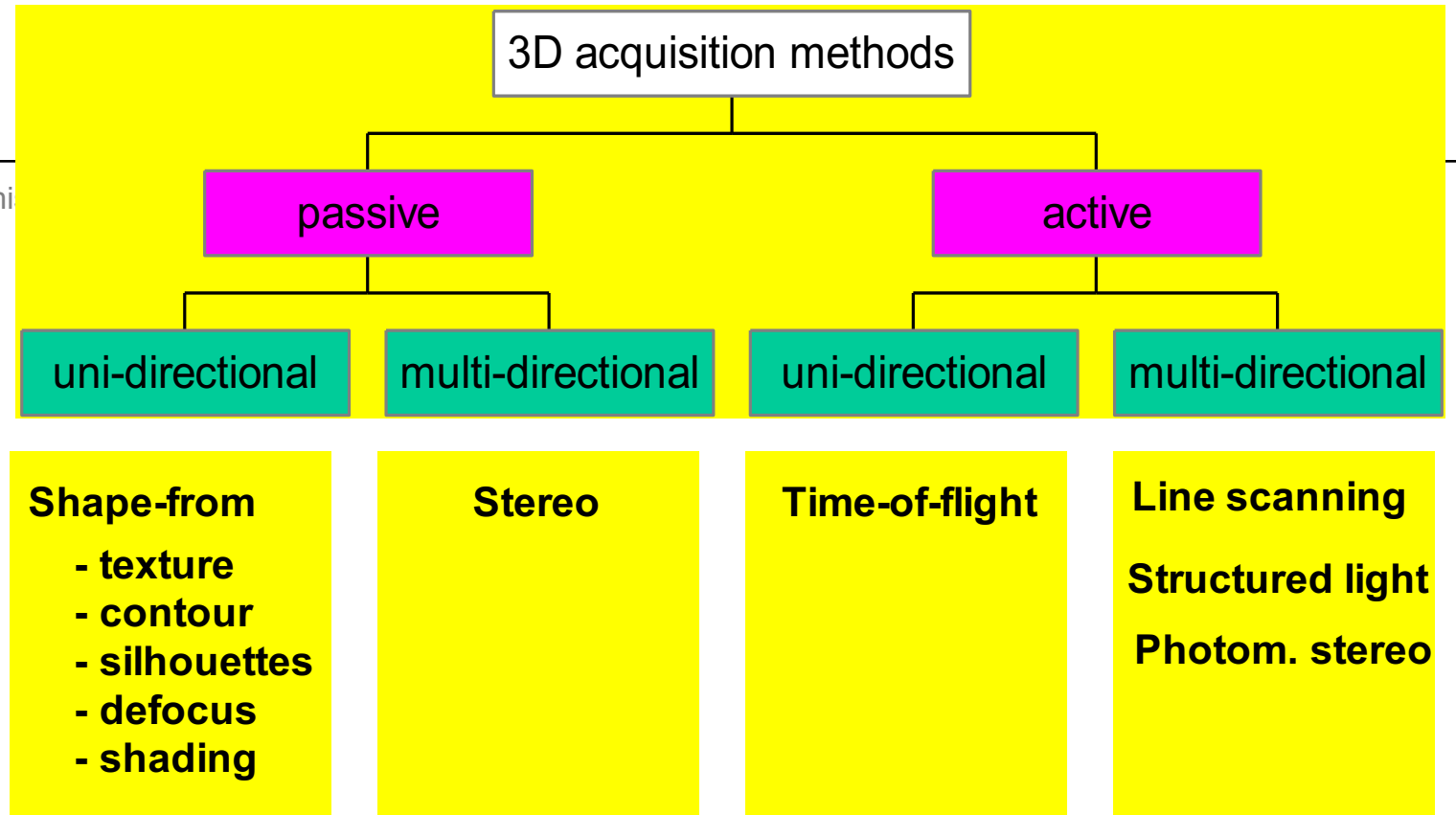

3D acquisition taxonomy



✖ Thi

3D acquisition taxonomy

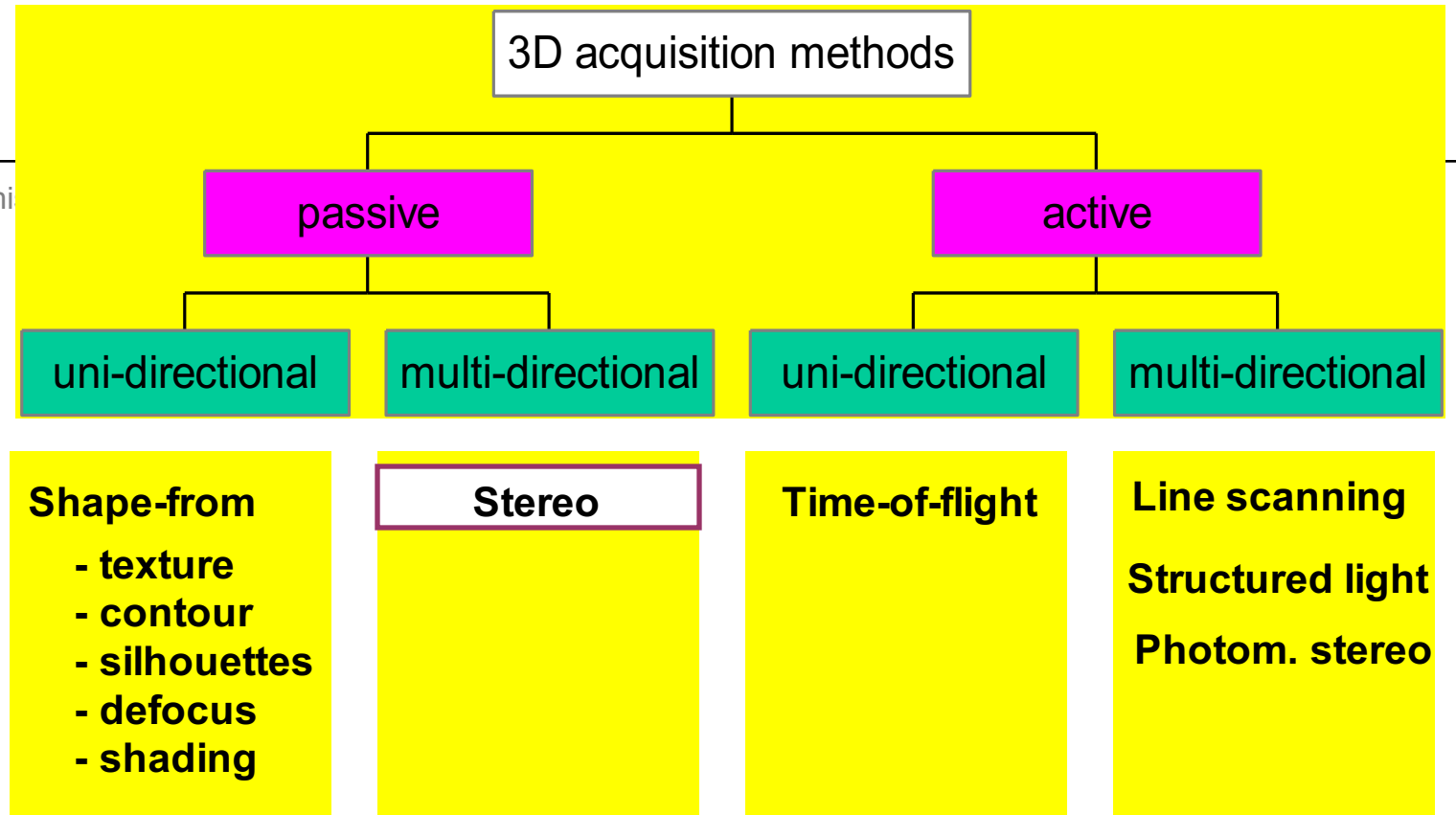

This

Stereo

The underlying principle is “triangulation” :

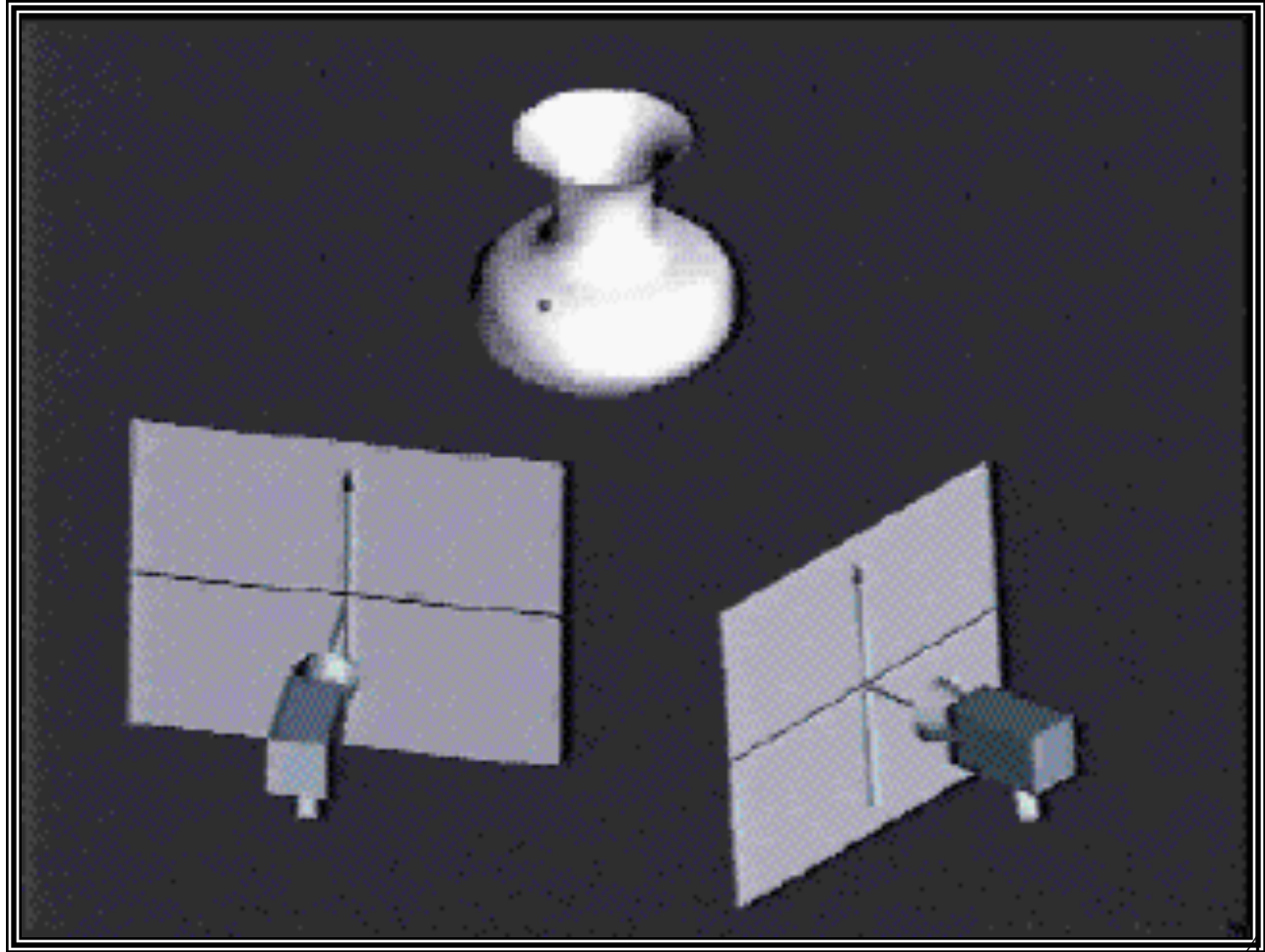

A simple stereo setup

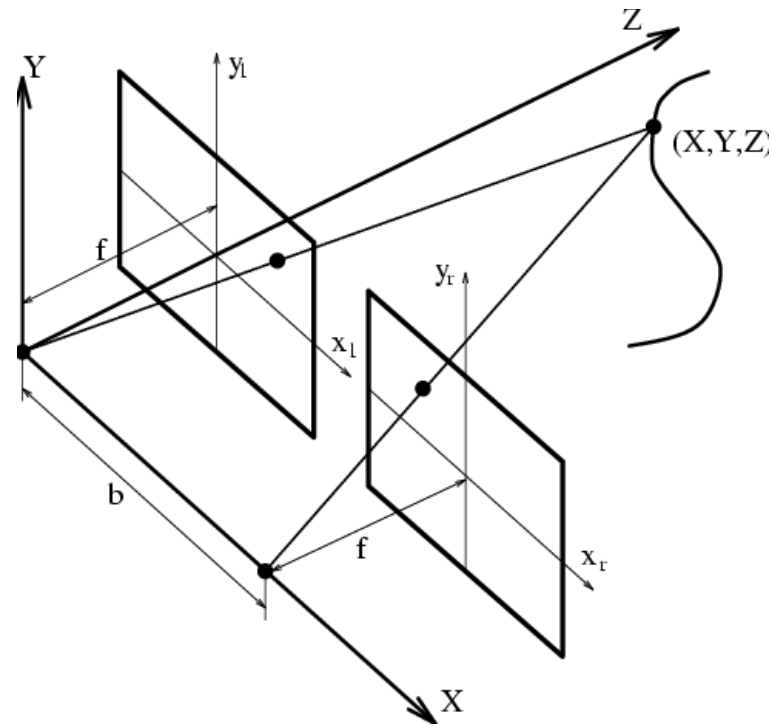

- identical cameras
- coplanar image planes
- aligned x -axes



A simple stereo setup

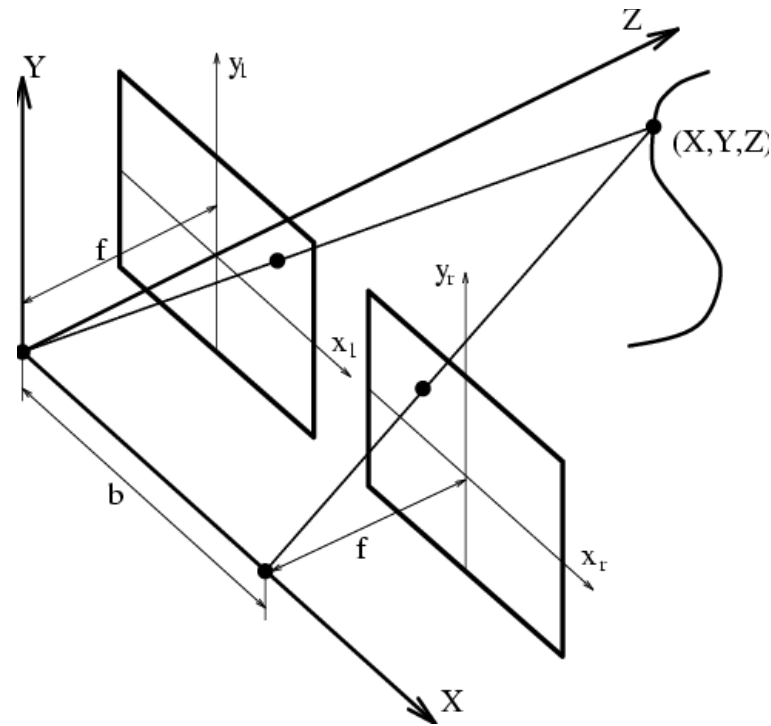

Reminder :

the camera projection can be formulated as

$$\rho p = KR^t (P - C) \quad \text{for some non-zero } \rho \in \mathbb{R}$$

Here R is the identity...



A simple stereo setup

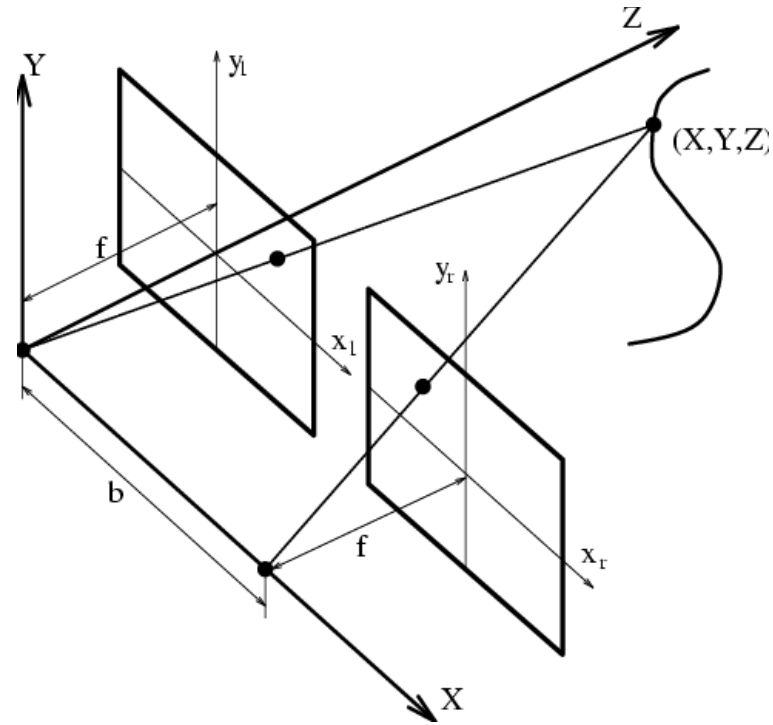

$$\rho \begin{pmatrix} x \\ y \\ 1 \end{pmatrix} = K \begin{pmatrix} X \\ Y \\ Z \end{pmatrix} \quad \rho' \begin{pmatrix} x' \\ y' \\ 1 \end{pmatrix} = K \begin{pmatrix} X - b \\ Y \\ Z \end{pmatrix} \quad K = \begin{pmatrix} fk_x & 0 & 0 \\ 0 & fk_y & 0 \\ 0 & 0 & 1 \end{pmatrix}$$



A simple stereo setup

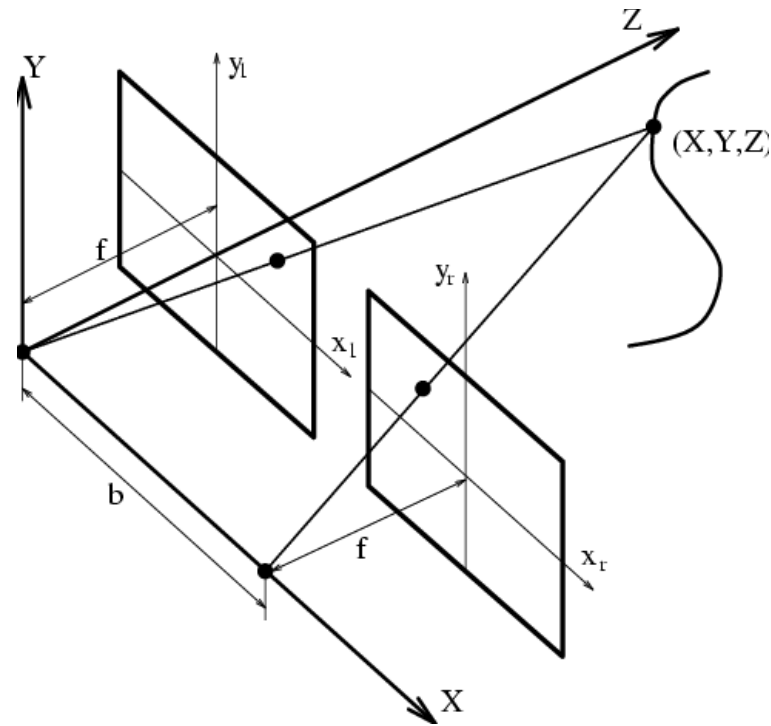

$$\begin{cases} x = \frac{fk_x X}{Z}, \\ y = \frac{fk_y Y}{Z}, \end{cases} \quad \text{and} \quad \begin{cases} x' = \frac{fk_x (X - b)}{Z}, \\ y' = \frac{fk_y Y}{Z}, \end{cases}$$

Note that $y = y'$



A simple stereo setup

The 3D coordinates of the point are

$$X = b \frac{x}{(x - x')},$$

$$Y = b \frac{k_x}{k_y} \frac{y}{(x - x')},$$

$$Z = bk_x \frac{f}{(x - x')}.$$

$(x - x')$ is the so-called *disparity*

Stereo is imprecise for far away objects, but increasing b and/or f can increase depth resolution



A simple stereo setup

Notice: for this simple setup, same disparity means same depth

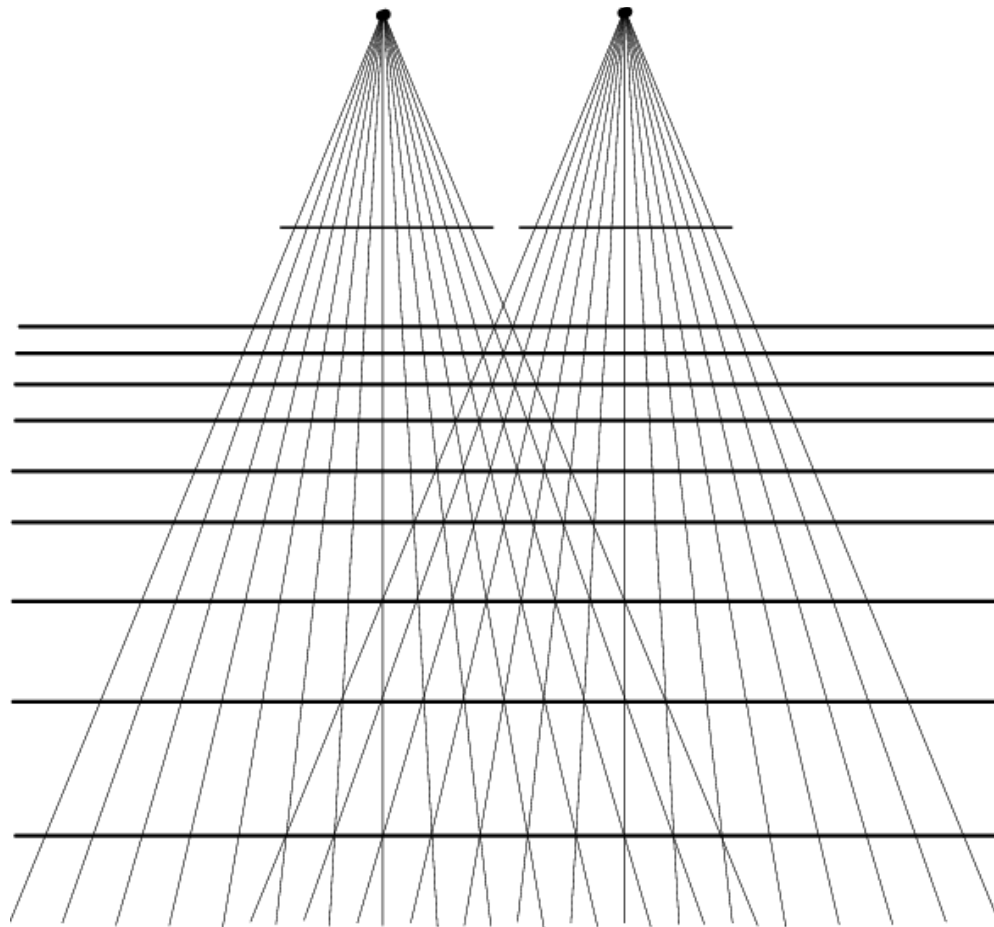

same disparity means same depth

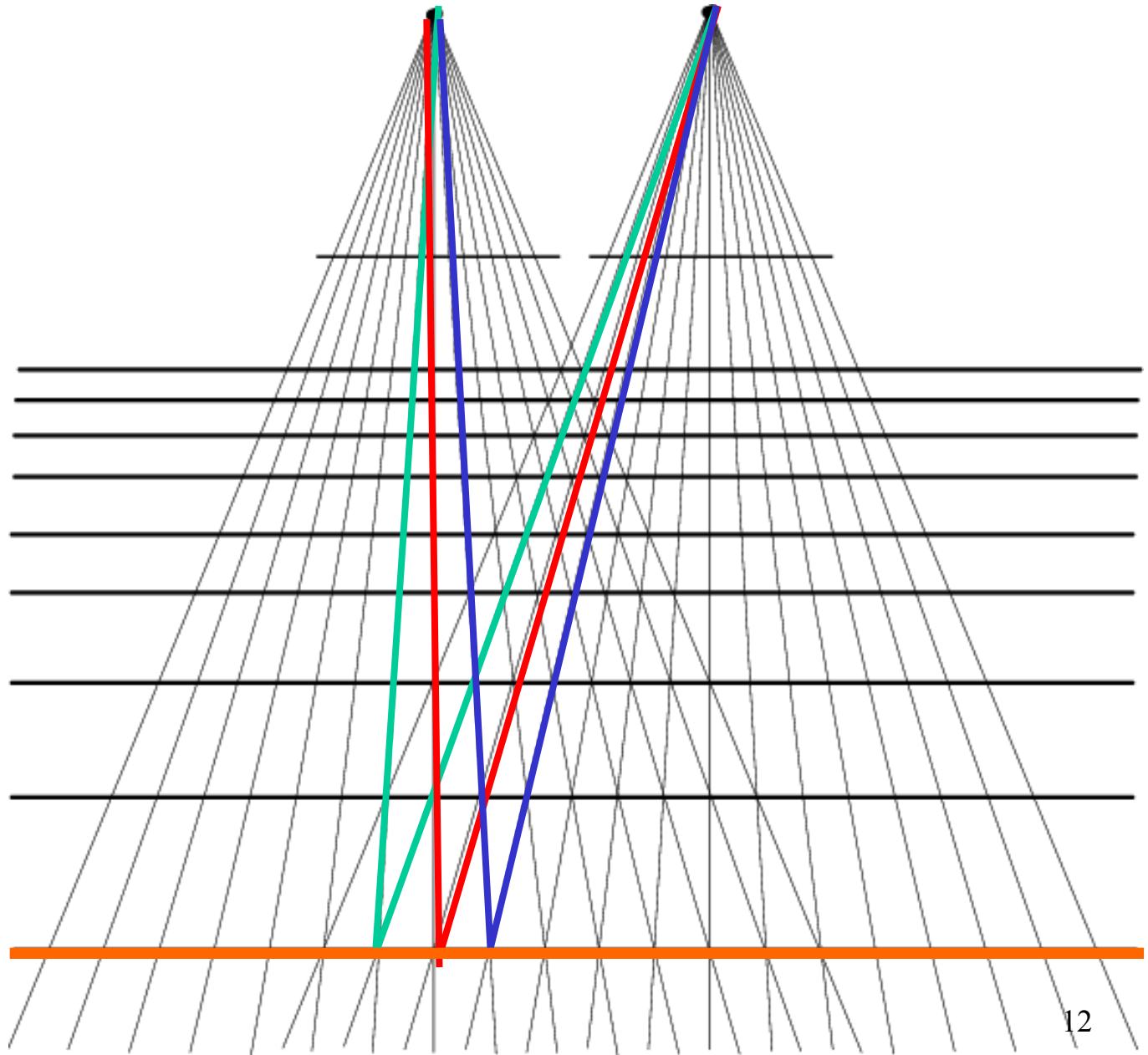

A simple stereo setup

Increasing b increases depth resolution

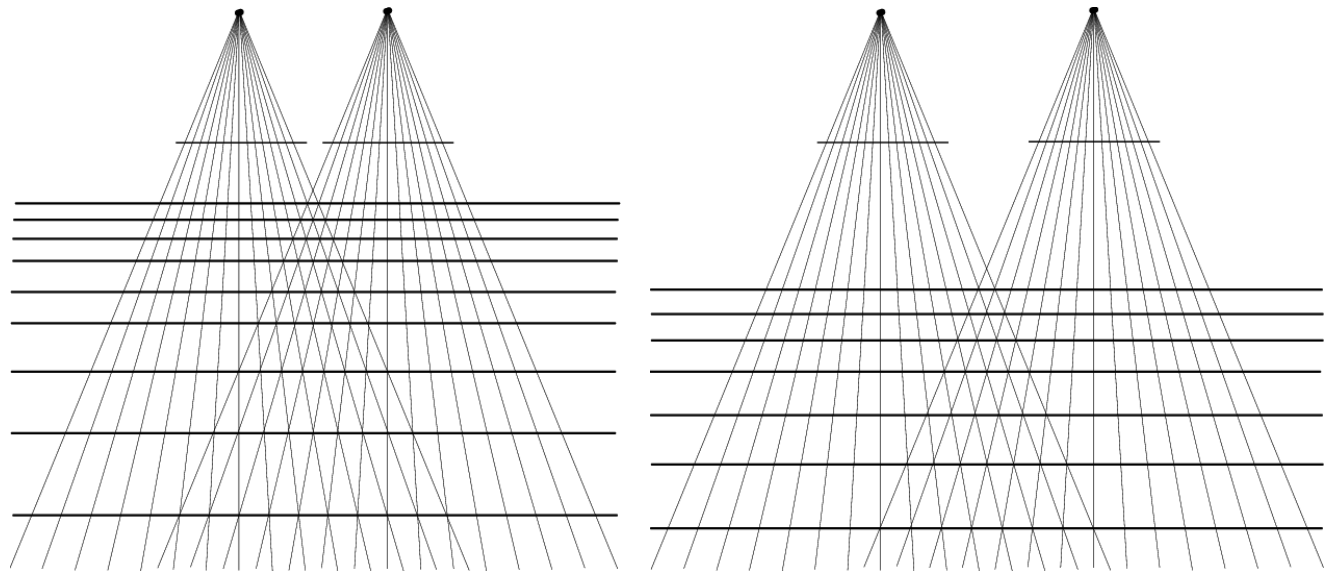

one has to strike a balance with visibility...



A simple stereo setup

Increasing f increases depth resolution

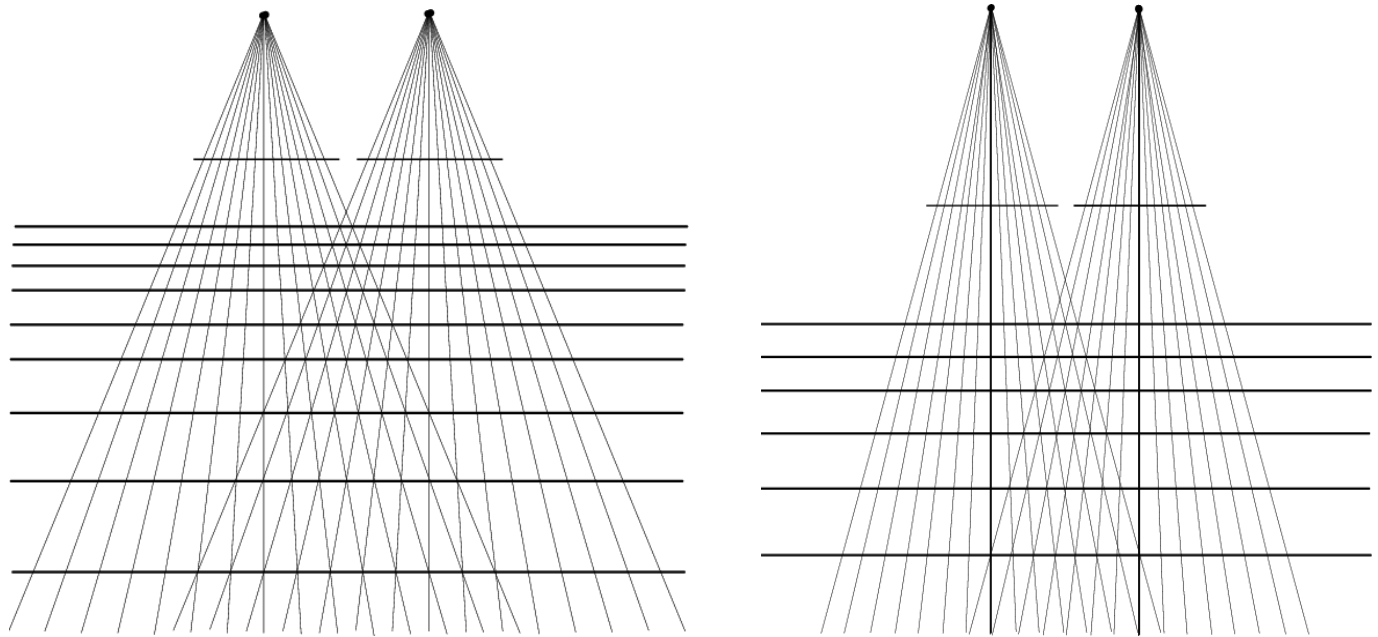

one has to strike a balance with visibility...



Remarks

- ❑ 1. increasing b and/or f increases depth resolution but reduces simultaneous visibility
- ❑ 2. iso-disparity loci are depth planes, not so for other configurations
- ❑ 3. as soon as the disparity gets too small, depth difference can no longer be seen; hence human stereo only works up to ± 10 m
- ❑ 4. the real problem is finding correspondences



A simple stereo setup



The HARD problem is finding the *correspondences*

Notice : no reconstruction for the untextured back wall...



A simple stereo setup

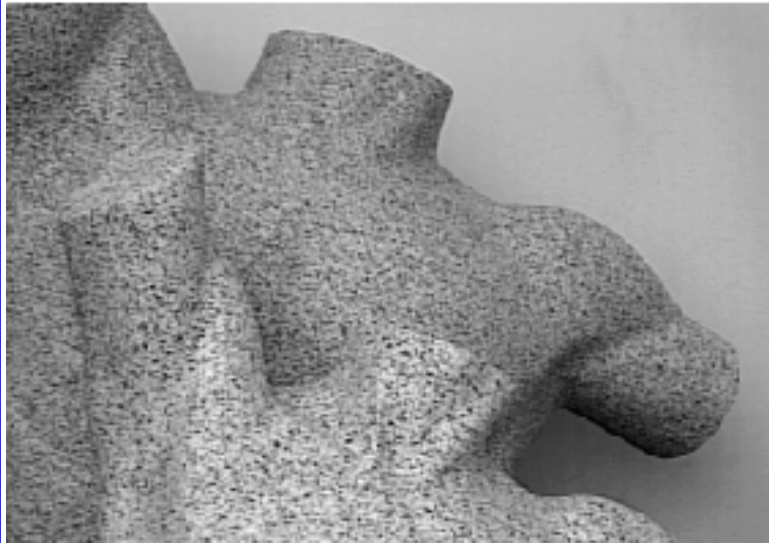

The HARD problem is finding the *correspondences*

Notice : no reconstruction for the untextured back wall...







Stereo, the general setup

we start by the relation between the 2 projections of a point to ease correspondence search

in the second image the point must be along the projection of the viewing ray for the first camera :

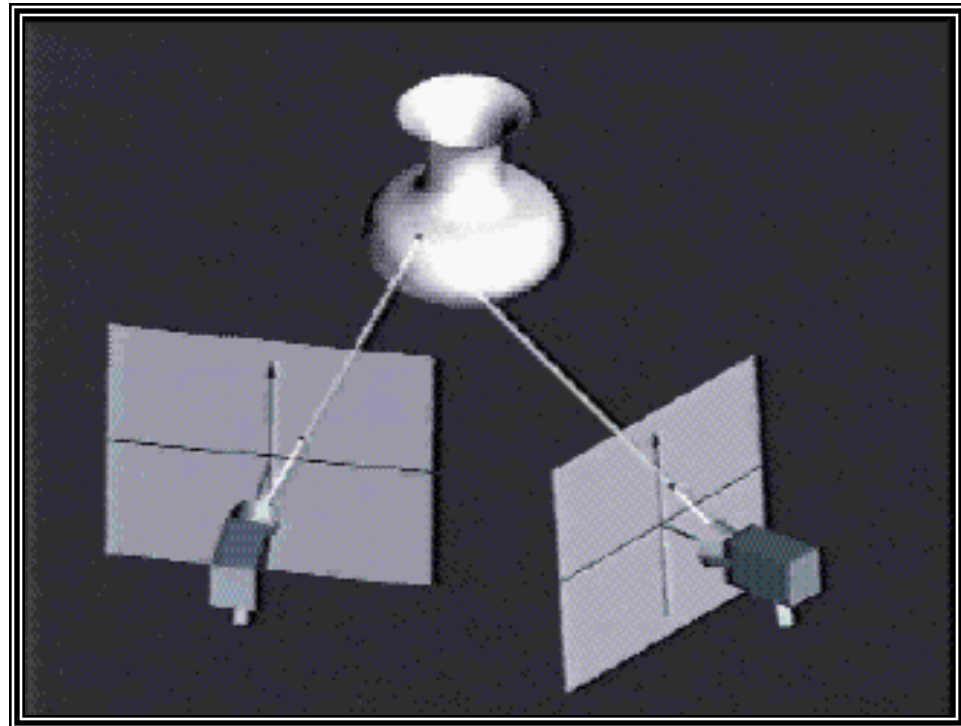

Stereo, the general setup

We cast this constraint in mathematical expressions :

p and p' are the two images of P

$$\mu p = K R^t (P - C)$$

$$\rho' p' = K' R'^t (P - C')$$

w.r.t. world frame P is on the ray with equation

$$P = C + \mu R K^{-1} p \quad \text{for some } \mu \in \mathbb{R}$$



Stereo, the general setup

so, the ray is given by

$$P = C + \mu RK^{-1}p \text{ for some } \mu \in \mathbb{R}$$

Now we project it onto the second image
In general, points project there as follows :

$$\rho'p' = K'R'^t(P - C')$$

and thus, filling in the ray's equation

$$\rho'p' = \mu K'R'^t RK^{-1}p + K'R'^t(C - C')$$



Stereo, the general setup

the projected ray was found to be

$$\rho' p' = \mu K' R'^t R K^{-1} p + K' R'^t (C - C')$$

the second term is the projection of the 1st camera's center, the so-called *epipole*

$$\rho'_e e' = K' R'^t (C - C')$$

the first term is the projection of the ray's point at infinity, the so-called *vanishing point*

finally, adopting the simplifying notation

$$A = \frac{1}{\rho'_e} K' R'^t R K^{-1} \quad \rho' p' = \mu A p + \rho'_e e'$$

A is the *infinity homography*



Stereo, the general setup

note that the epipole lies on all the epipolar lines

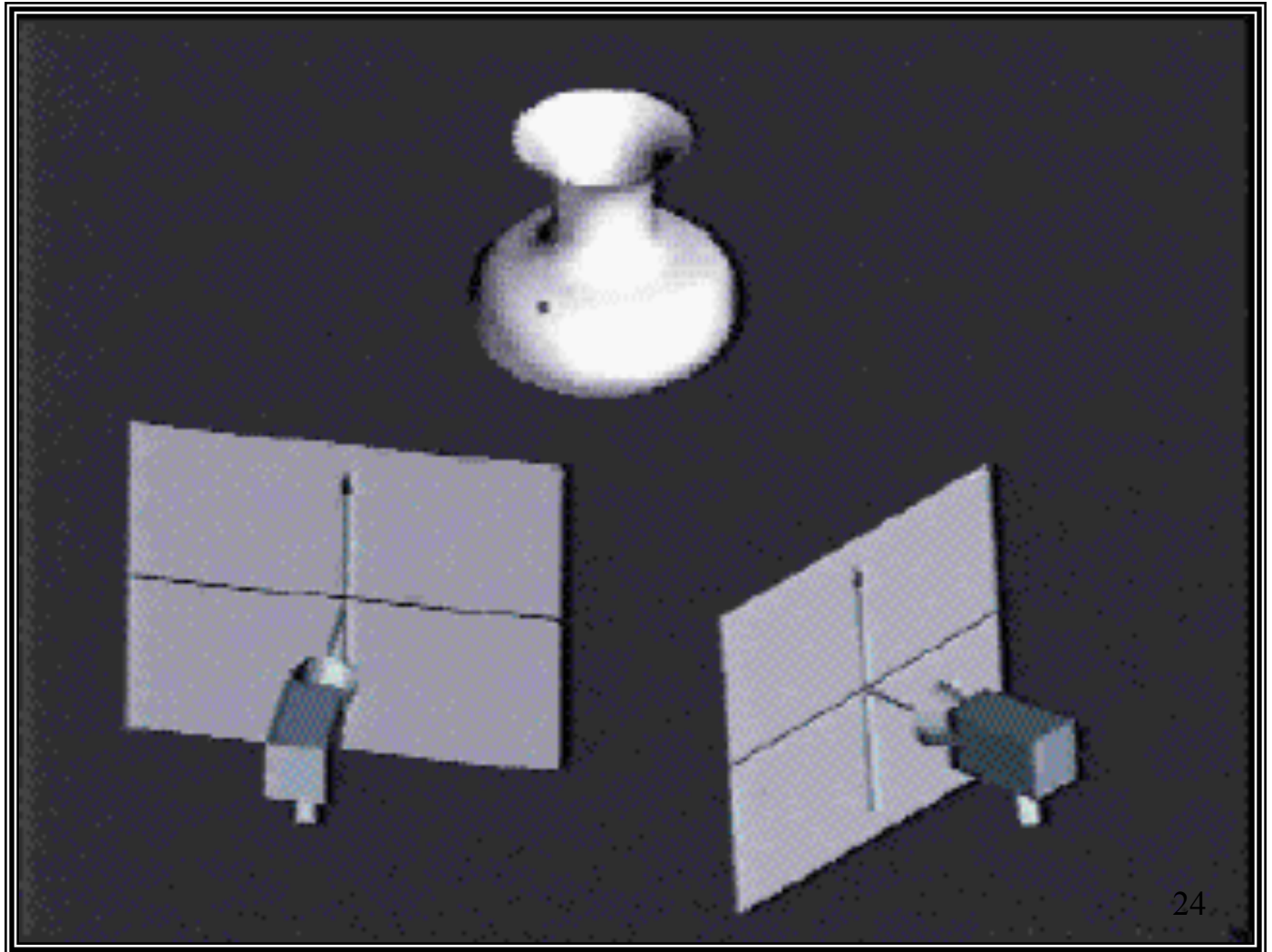

Stereo, the general setup

$$\rho' p' = \mu A p + \rho'_e e'$$



Stereo, the general setup

$$\rho' p' = \mu A p + \rho'_e e'$$

expresses that p' lies on the line l' through the epipole e' and the vanishing point $A p$ of the ray of sight of p (in the 2nd image)



Stereo, the general setup

$$\rho' p' = \mu A p + \rho'_e e'$$

the epipolar constraint (epipolar line)

we can rewrite this constraint as

$$|p' e' A p| = p'^t (e' \times A p) = 0$$



Stereo, the general setup

$$|p' e' A p| = p'^t (e' \times A p) = 0$$

can be written, given

as

$$[e']_{\times} = \begin{pmatrix} 0 & -e'_3 & e'_2 \\ e'_3 & 0 & -e'_1 \\ -e'_2 & e'_1 & 0 \end{pmatrix}$$

$$|p' e' A p| = p'^t [e']_{\times} A p$$

$F = [e']_{\times} A$ is the *fundamental matrix*

F is a 3x3 matrix, but has rank 2



Stereo, the general setup

$$p'^t [e']_{\times} Ap = 0 \quad \rightarrow \quad p'^t F p = 0$$

The 3-vector $p'^t F$ contains the line coordinates of the epipolar line of p' (i.e. a line in the 1st image that contains its corresponding point p)

The 3-vector $F p$ contains the line coordinates of the epipolar line of p (i.e. a line in the 2nd image that contains its corresponding point p')

Hence, the epipolar matrix works in both directions



Stereo, the general setup



Andrea Fusiello, CVonline

Epipolar geometry cont'd



Epipolar geometry cont'd

- Epipolar lines are in mutual correspondence

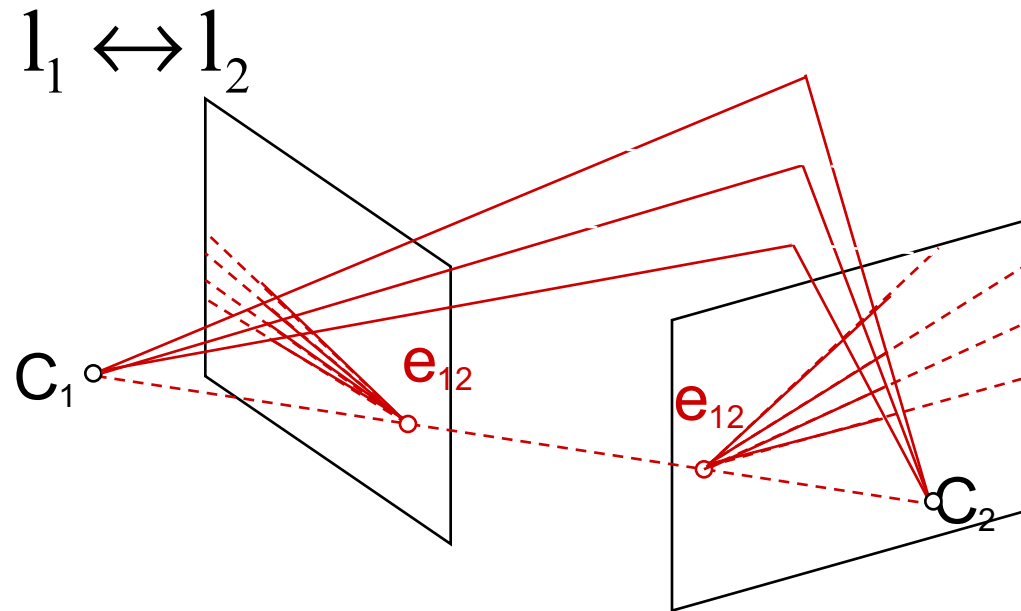

- allows to separate matching problem:
matching pts on an epipolar line to pts on the
corresponding epipolar line

Exploiting epipolar geometry

Separate 2D correspondence search problem to 1D search problem by using two view geometry

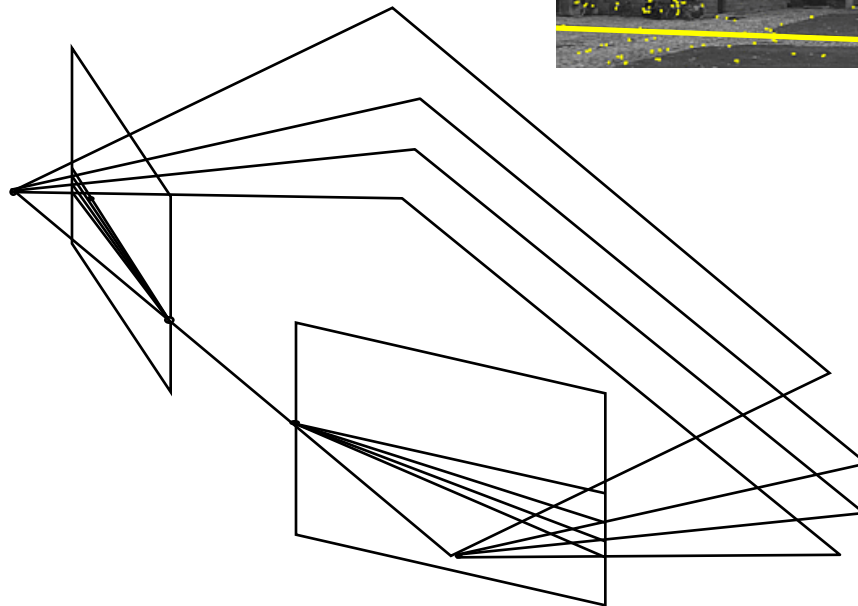

Epipolar geometry cont'd



Stereo, the general setup

- ❑ one point yields one equation $p'^t F p = 0$ that is linear in the entries of the fundamental matrix F
so, we can actually obtain F without any prior knowledge about camera settings if we have sufficient pairs of corresponding points !!
- ❑ F can be computed *linearly* from 8 pairs of corresponding points,
i.e. already from 8 `correspondences'
(not 9, as this is a homogeneous system and one coefficient can be fixed to value 1 to fix the scale !)
- ❑ F being rank 2 yields an additional, but non-linear constraint. Thus, 7 correspondences suffice to *non-linearly* solve for F



Stereo, the general setup

Remarks :

- ❑ Of course, in practice one wants to use as many Correspondences as available, e.g. for obtaining a least-squares solution, based on the linear system, followed by a step to impose rank 2.
- ❑ Often, F is found through a procedure called RANSAC (RANDOM Sample Consensus). It starts from a randomly drawn subset of correspondences of minimal size (e.g. 8), and then keeps on drawing until a subset is found that yields an F so that many correspondences are seen to obey the epipolar constraint. RANSAC is good to fend off against correspondences that are wrong ('outliers'₃₆)



Relations between 3 views

one could use more than 2 images, e.g. 3
 suppose P projects to p, p' , and p''
 p'' is found at the intersection of epipolar lines :

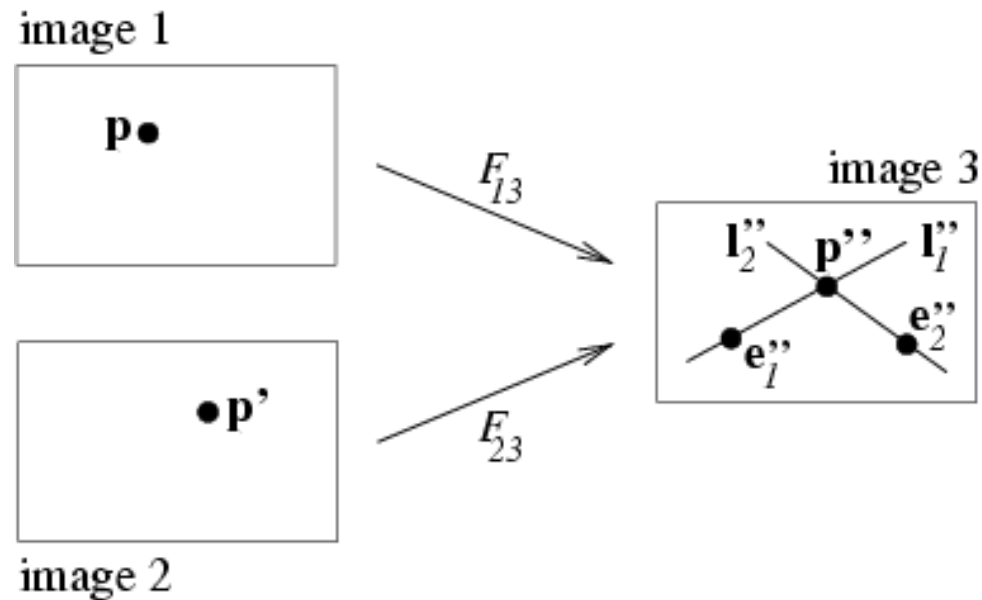

fails when the epipolar lines coincide

⇒

trifocal constraints



Computer Vision



Correspondence problem : constraints

Reducing the search space :

- 1. Points on the epipolar line
- 2. Min. and max. depth \Rightarrow line segment
- 3. Preservation of order
- 4. Smoothness of the disparity field



Correspondence problem : methods

1. correlation

- ❑ deformations...
- ❑ small window \Rightarrow noise!
- ❑ large window \Rightarrow bad localisation

2. feature-based

- ❑ mainly edges and corners
- ❑ sparse depth image

3. regularisation methods



Stereo, the general setup

3D reconstruction

$$P = C + \mu RK^{-1} p$$

$$P = C' + \mu' R' K'^{-1} p'$$

Yields 6 equations in 5 unknowns X, Y, Z
and μ, μ'

However, due to noise and errors, the rays may
not intersect!

⇒ e.g. use the middle where the rays come
closest



3D city models

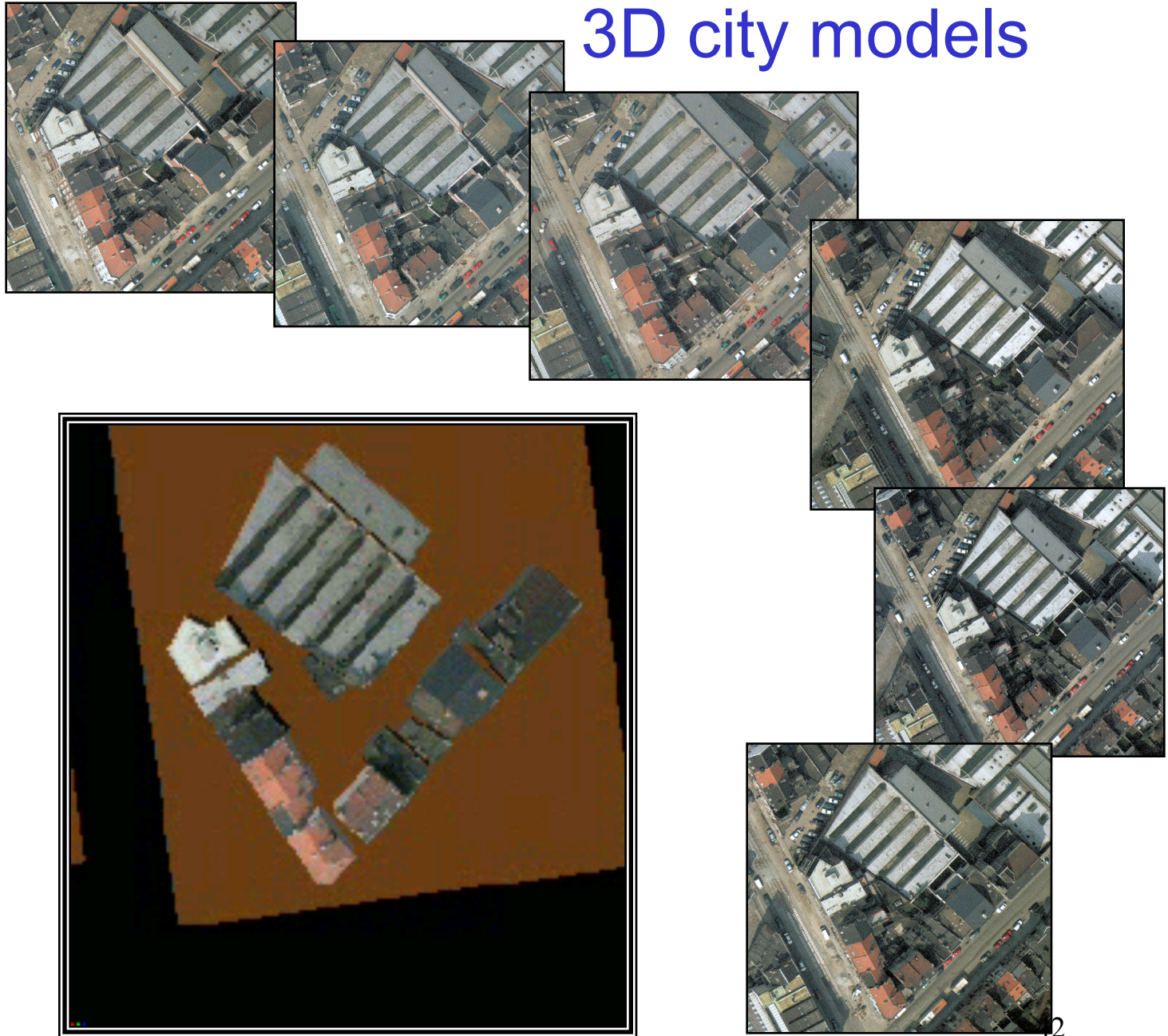

3D city models – ground level

Mobile mapping example – for measuring



3D city models – ground level

Can also be turned into 3D for visualisation, but one needs to stay close to the camera viewpoints.

The example shown is of Quebec

3D city models – ground level

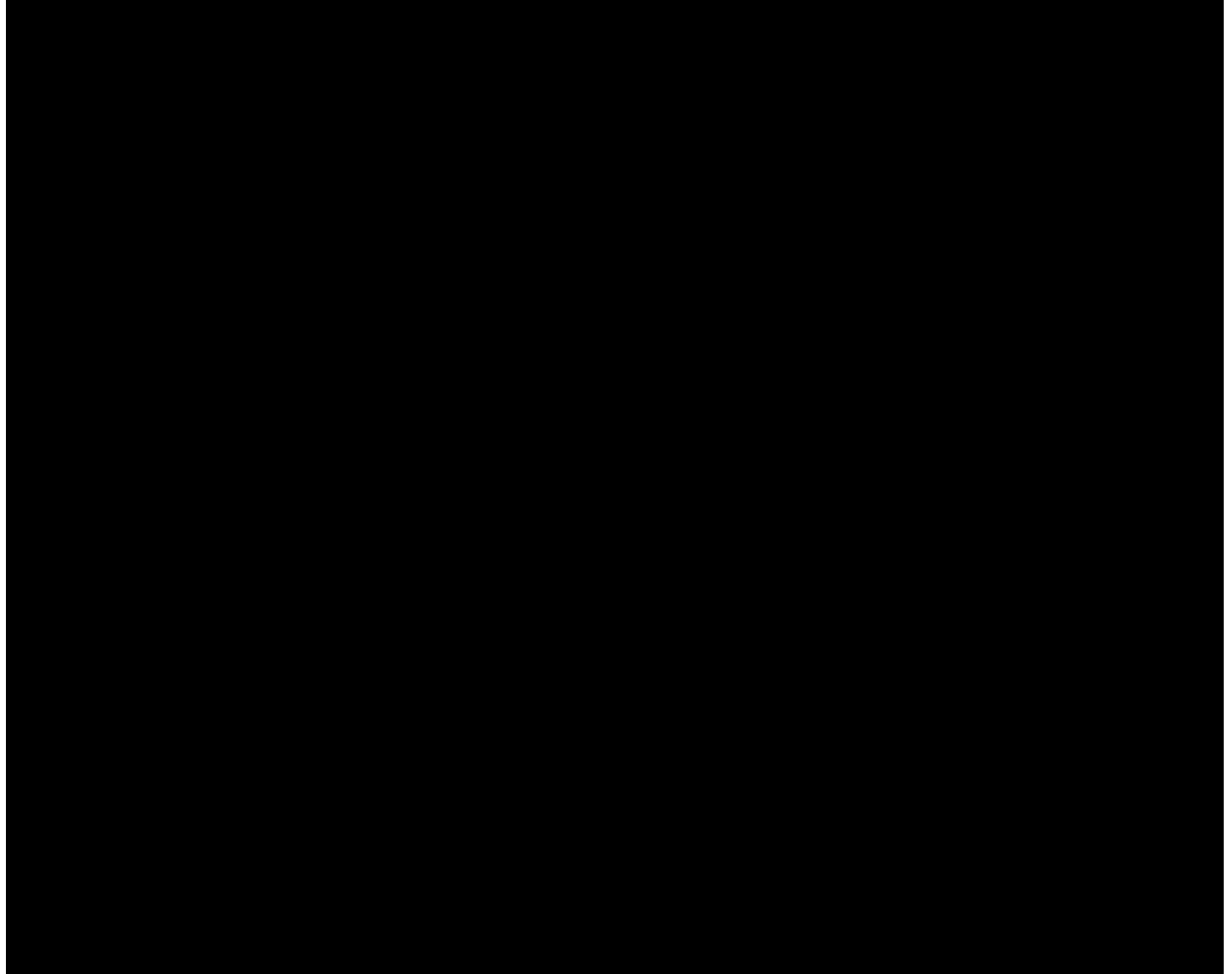

Uncalibrated reconstruction

From 2 views...



If the camera
translates...

An affine reconstruction can be made

A projective reconstruction is always possible

(if no pure rot.)



Uncalibrated reconstruction

From 3 general views
taken with the same camera parameters...



A metric reconstruction is possible



Uncalibrated reconstruction



Tracking
and
Calibration

Dense
depth
estimation

3D
surface
modeling



Points and cameras



Depth map

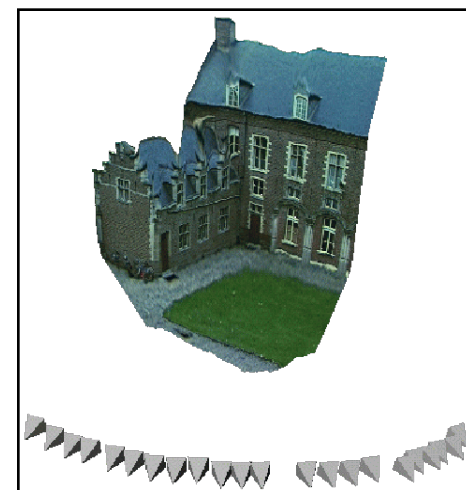

3D models⁴⁸

Uncalibrated reconstruction



Uncalibrated reconstruction - example



Univ. of Leuven



Input Images

shots taken with Canon EOS D60

(Resolution: 6,3 Megapixel)

Shape-from-stills

www.arc3d.be

Webservice,
free for non-commercial use

3D acquisition taxonomy

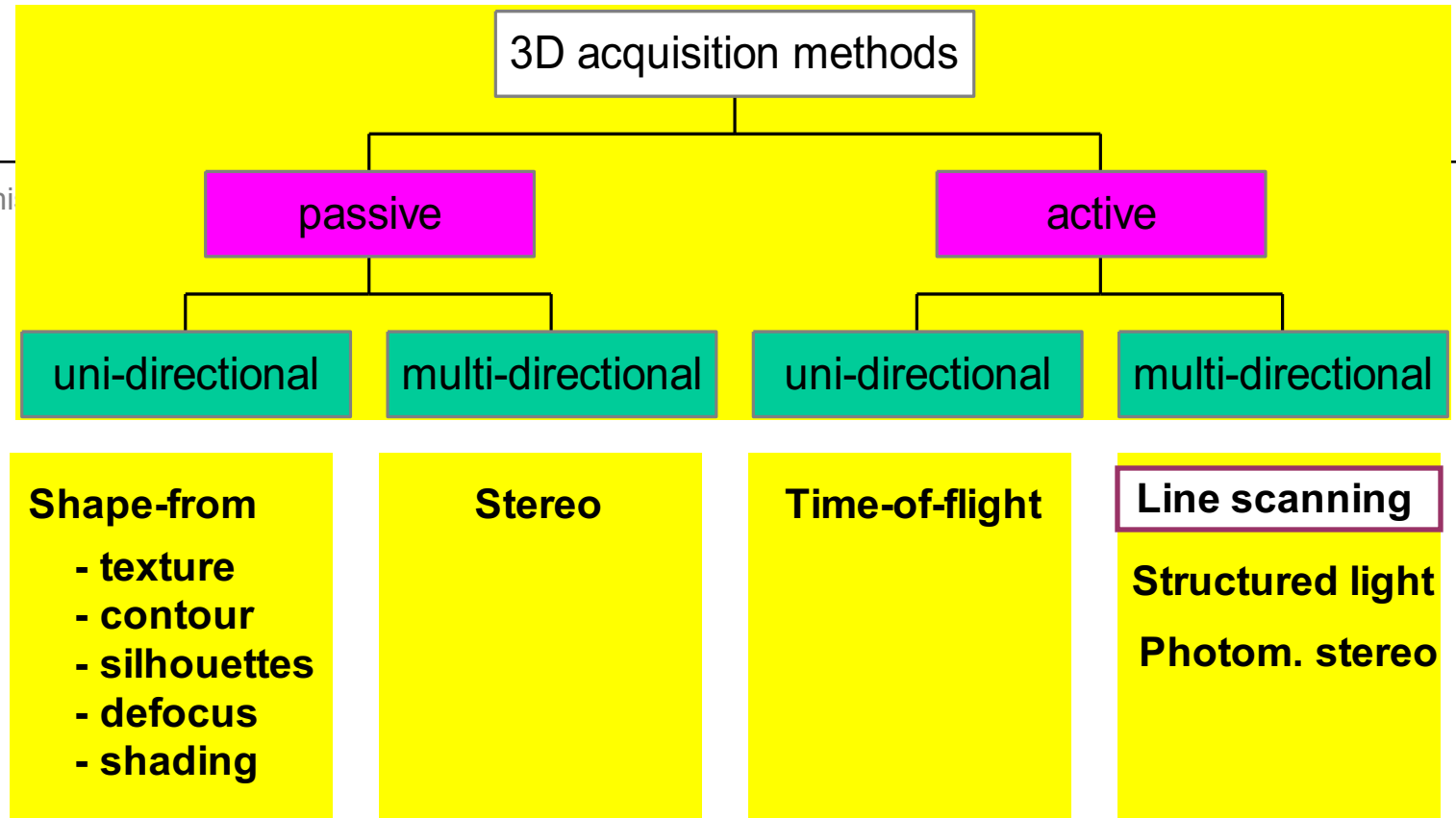

Active triangulation

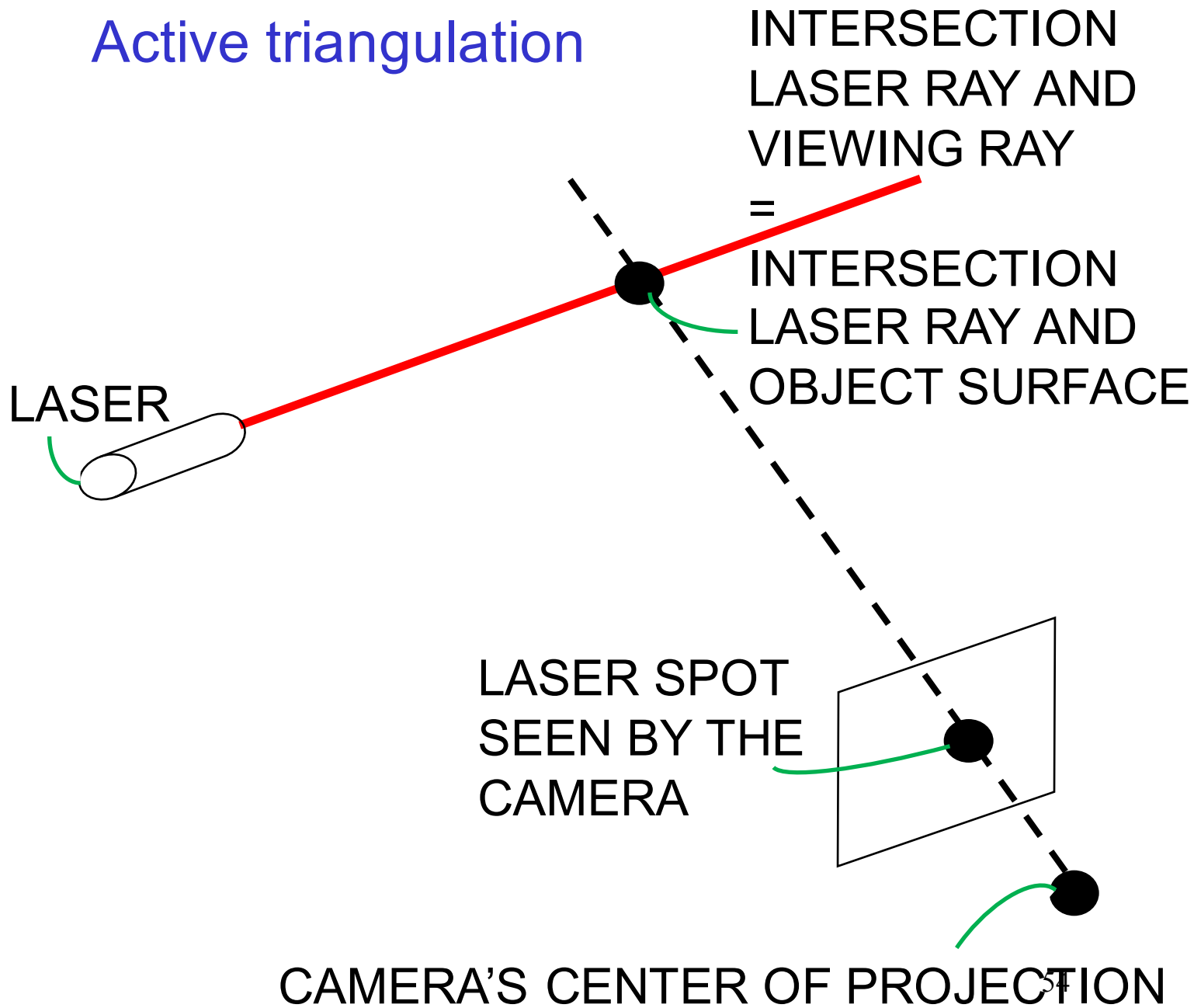

Active triangulation

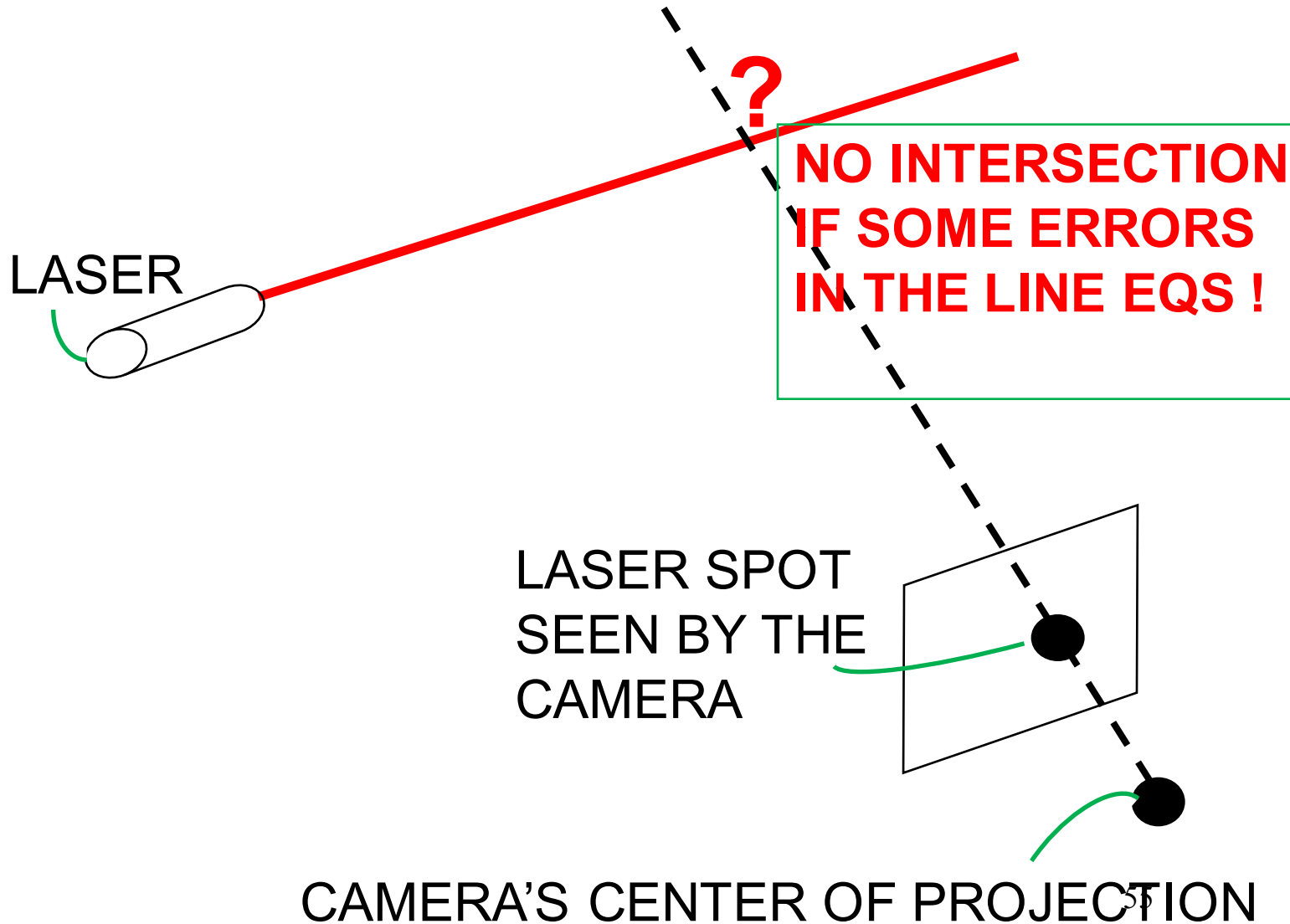

Active triangulation

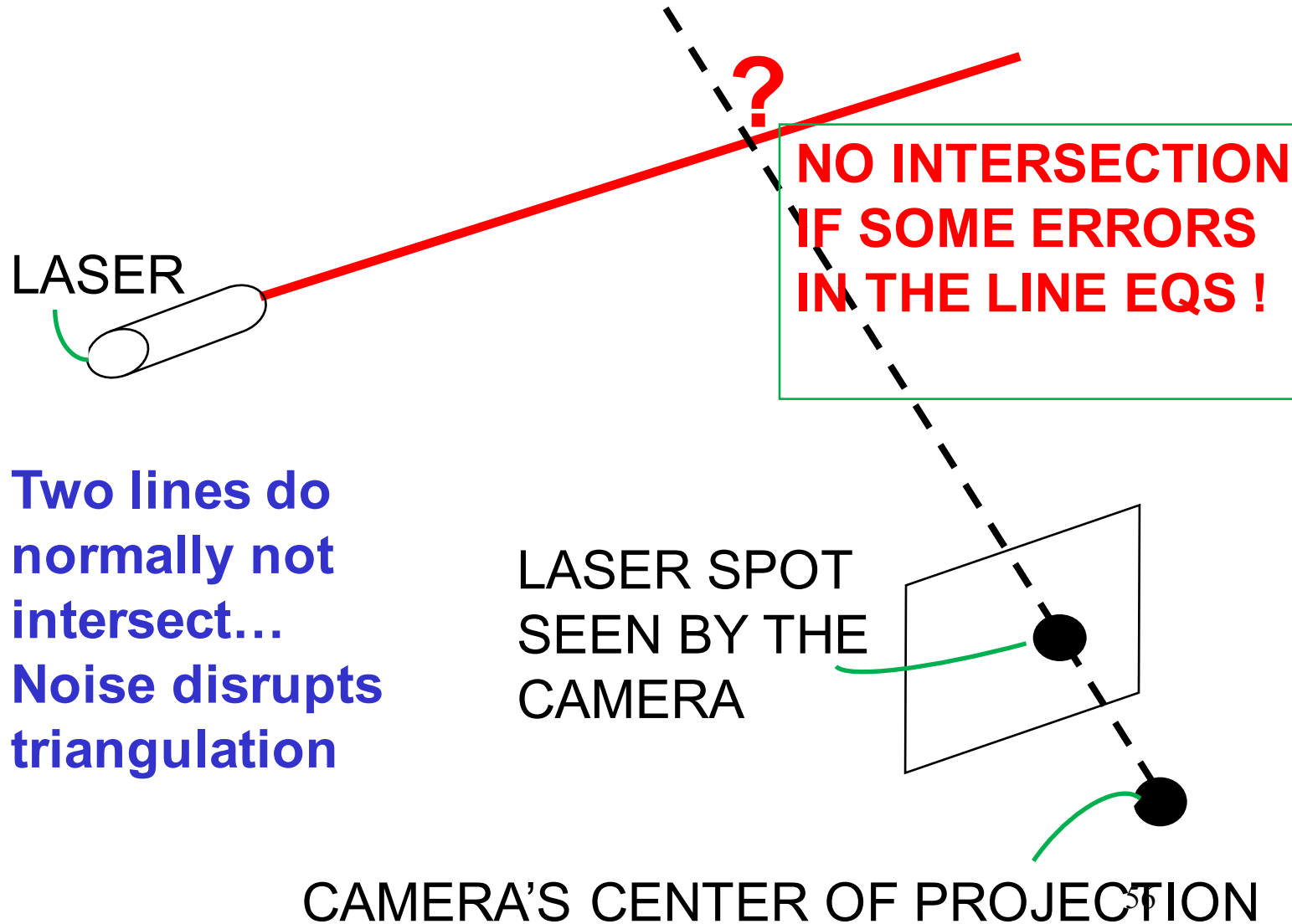

Active triangulation

LASER WITH
CYLINDRICAL
LENS IN
FRONT



INTERSECTION
LASER PLANE &
OBJECT SURFACE

INTERSECTION
LASER PLANE &
VIEWING RAY

POINT ON THE
LASER LINE
SEEN BY THE
CAMERA

CAMERA'S CENTER OF PROJECTION

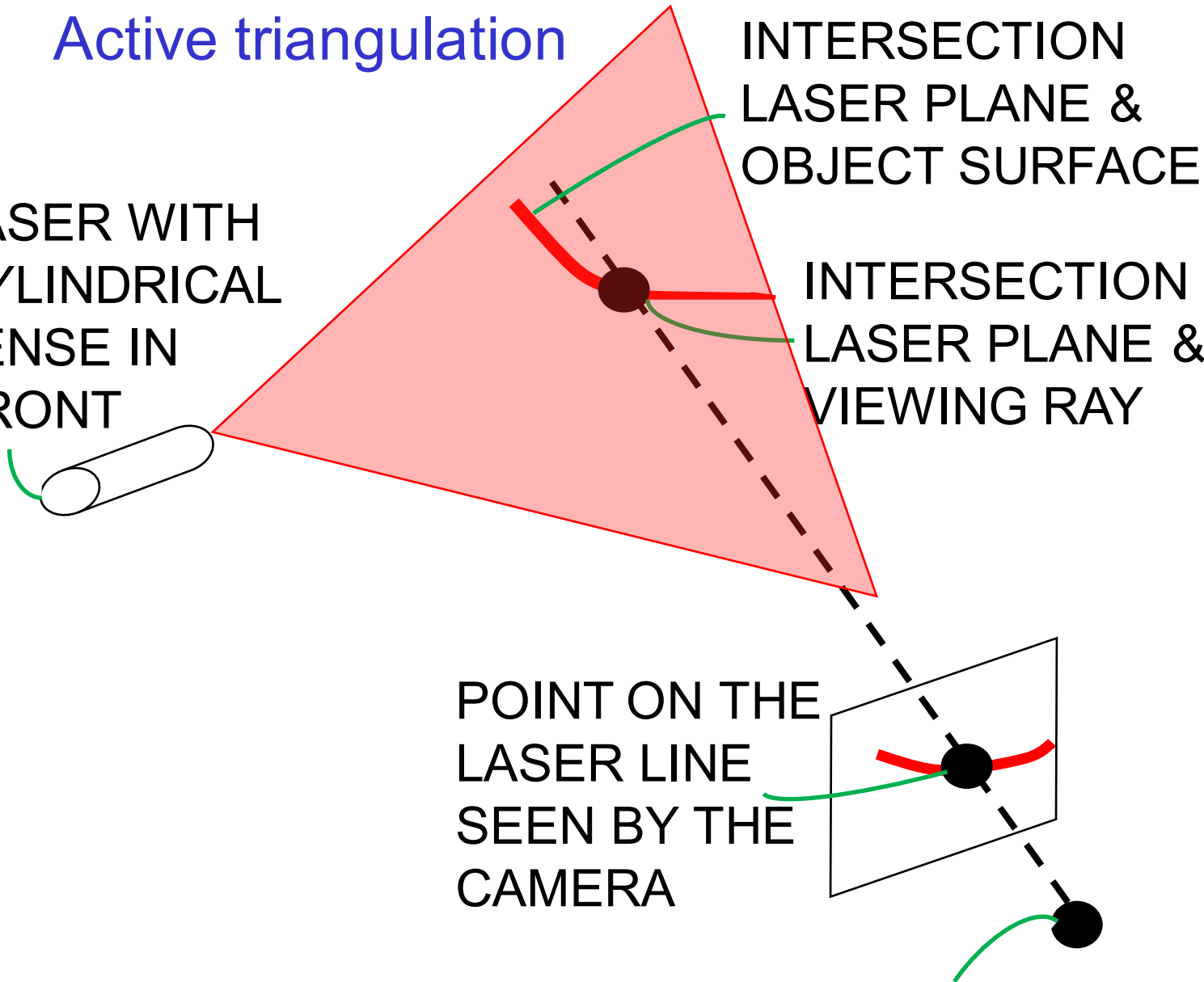

Active triangulation

LASER WITH
CYLINDRICAL
LENS IN
FRONT



INTERSECTION
LASER PLANE &
OBJECT SURFACE

INTERSECTION
LASER PLANE &
VIEWING RAY

**A plane and a
line do normally
intersect...
Noise has little
influence on the
triangulation**

POINT ON THE
LASER LINE
SEEN BY THE
CAMERA

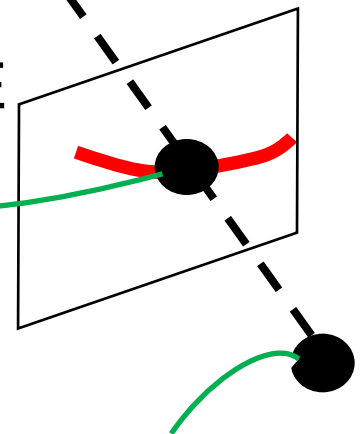

CAMERA'S CENTER OF PROJECTION

Active triangulation



Active triangulation

Triangulation \rightarrow 3D measurements

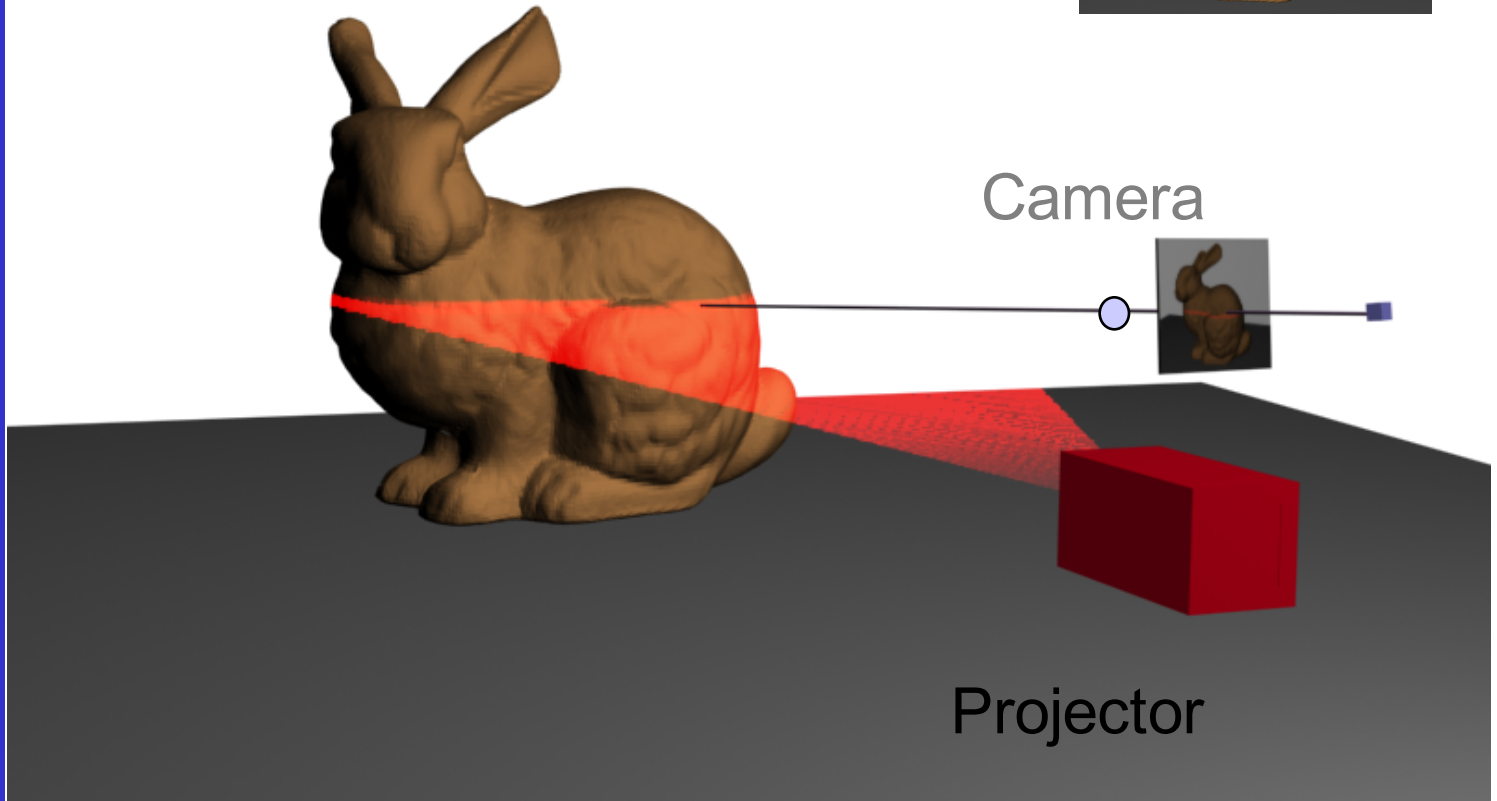
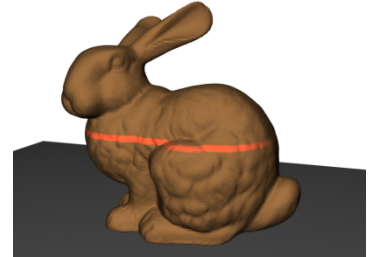

Active triangulation

Camera image

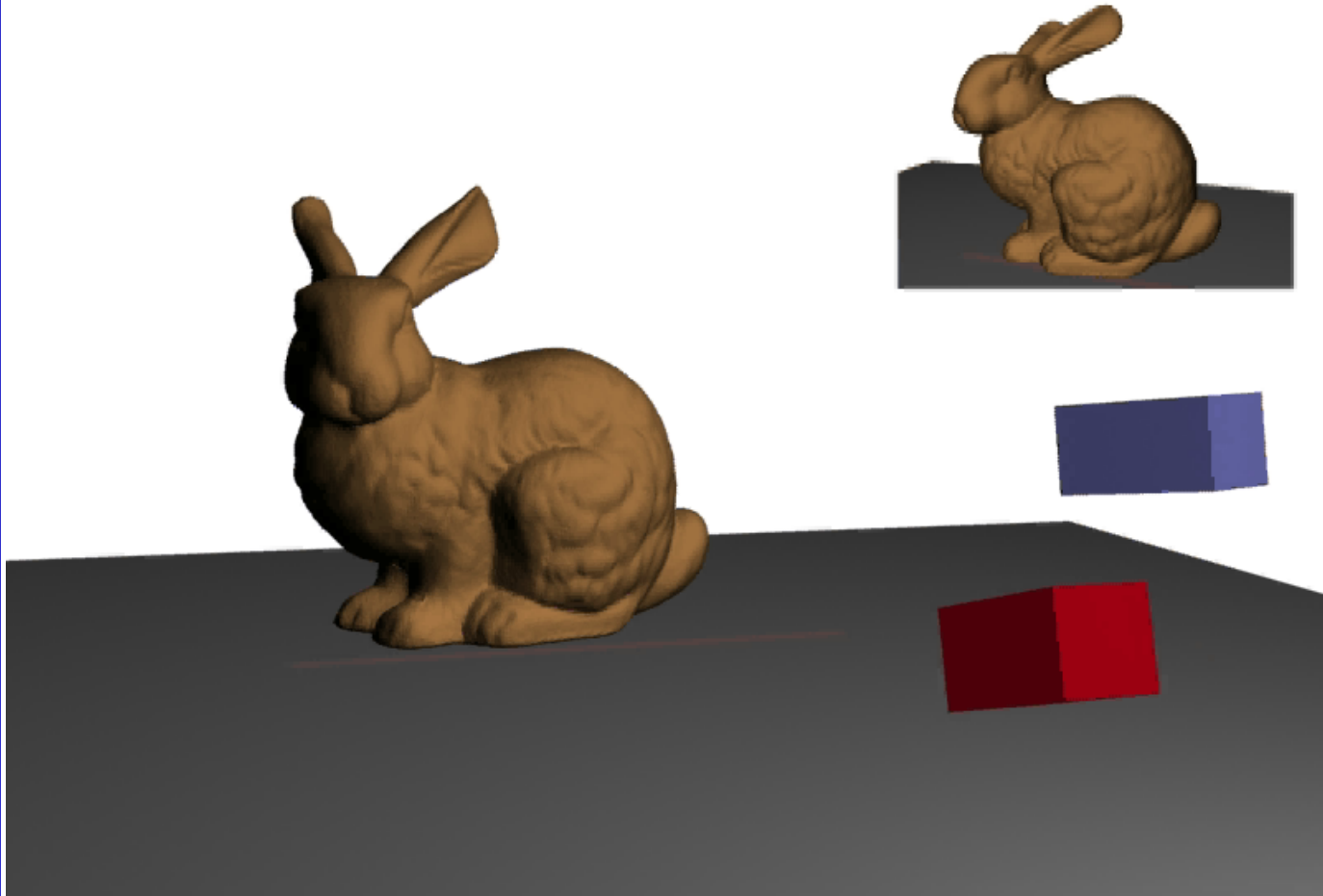

Active triangulation

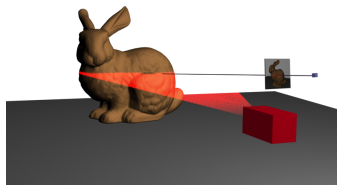
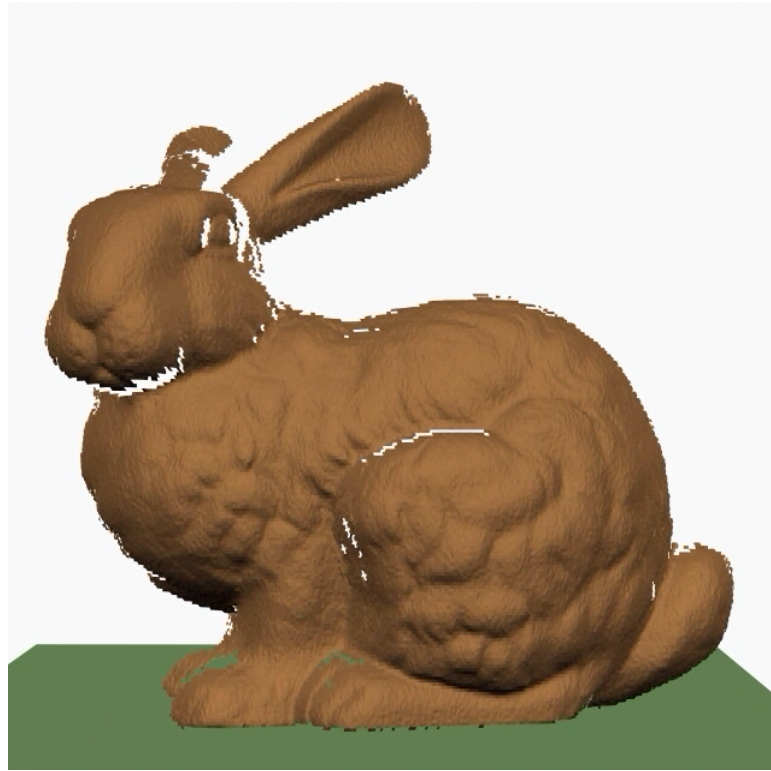

Active triangulation

Example 1 Cyberware laser scanners

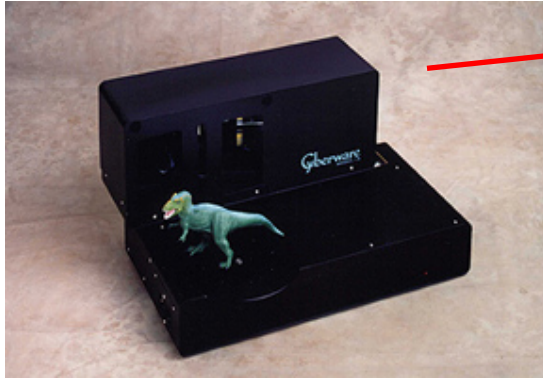

Desktop model
for small objects

Medium-sized objects



Body scanner

Head scanner



Active triangulation

Example 2 Minolta



Portable desktop model



3D acquisition taxonomy

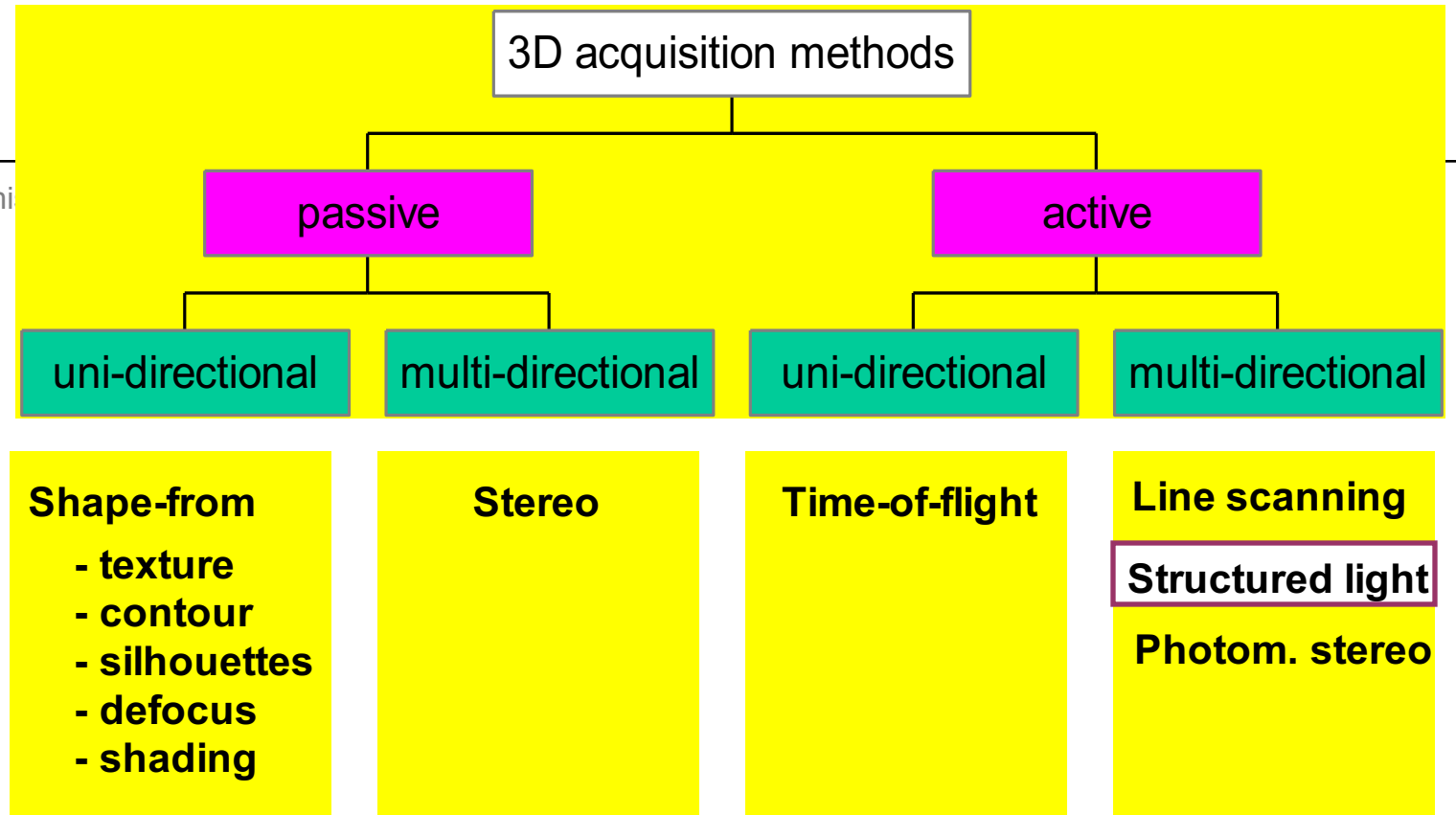

Structured light

patterns of a special shape are projected onto the scene

deformations of the patterns yield information on the shape

Focus is on combining a good resolution with a minimum number of pattern projections



Serial binary patterns

A sequence of patterns with increasingly fine subdivisions

Yields 2^n identifiable lines for only n patterns

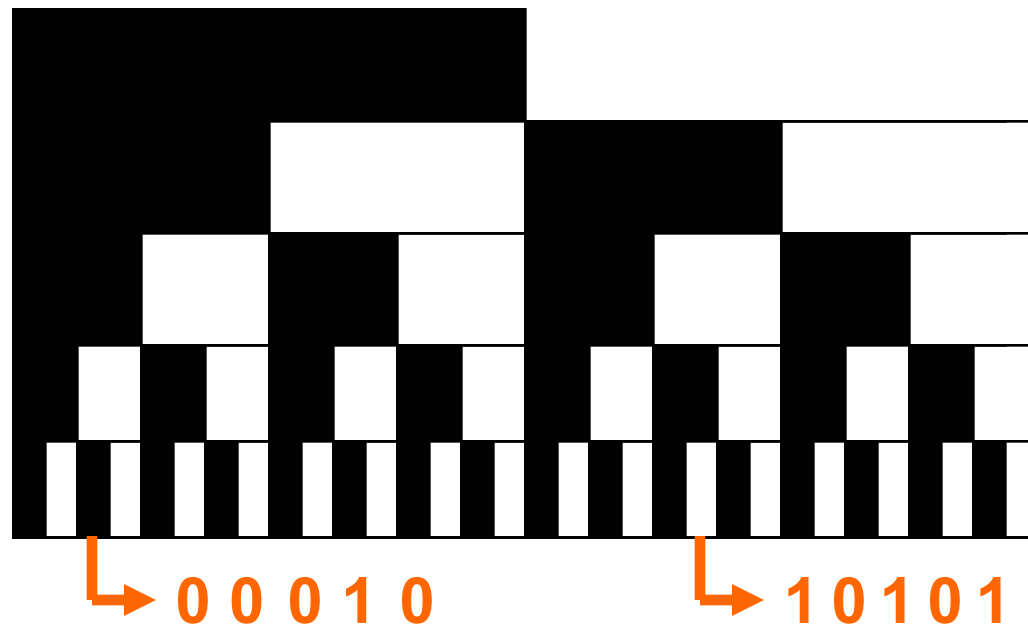

Reducing the nmb of projections: colour

Binary patterns

Yields 2^n identifiable lines for only n patterns

Using colours, e.g. 3,

Yields 3^n identifiable lines for only n patterns

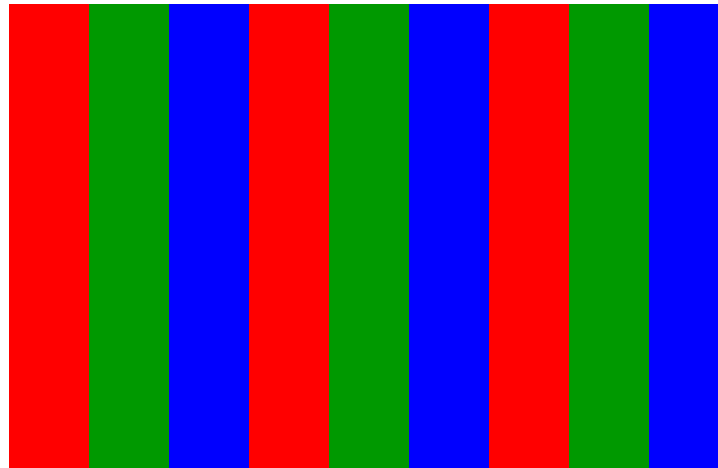

Interference from object colours...



One-shot implementation

3D from a single frame – KULeuven '96:

① projector



② camera



One-shot implementation

KULeuven '81: checkerboard pattern with column code

example :



3D reconstruction for the example

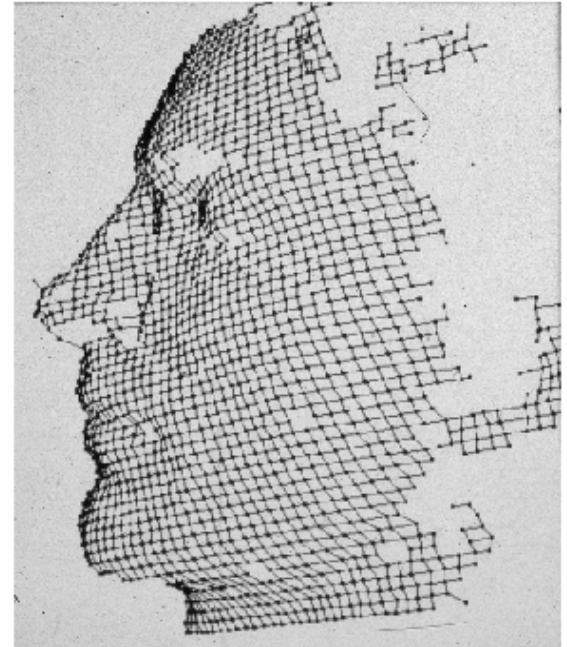
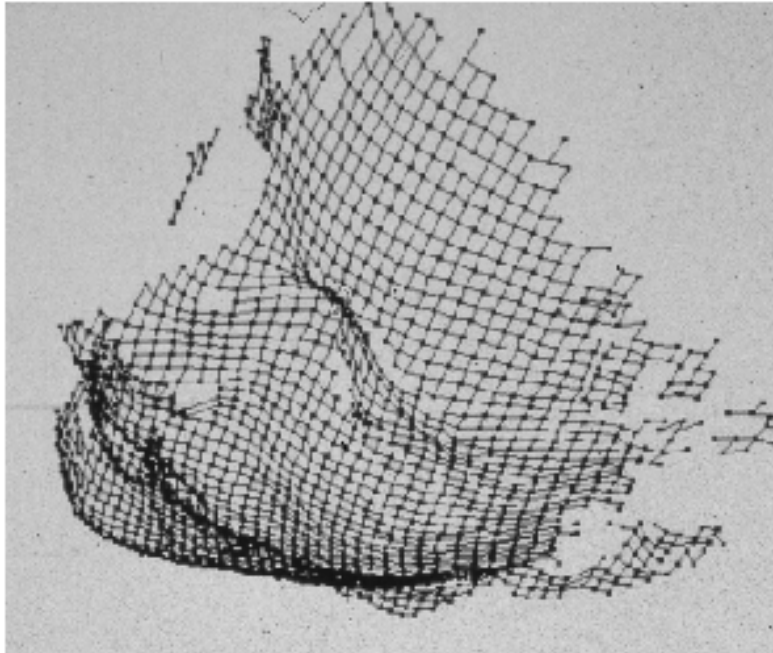

An application in agriculture

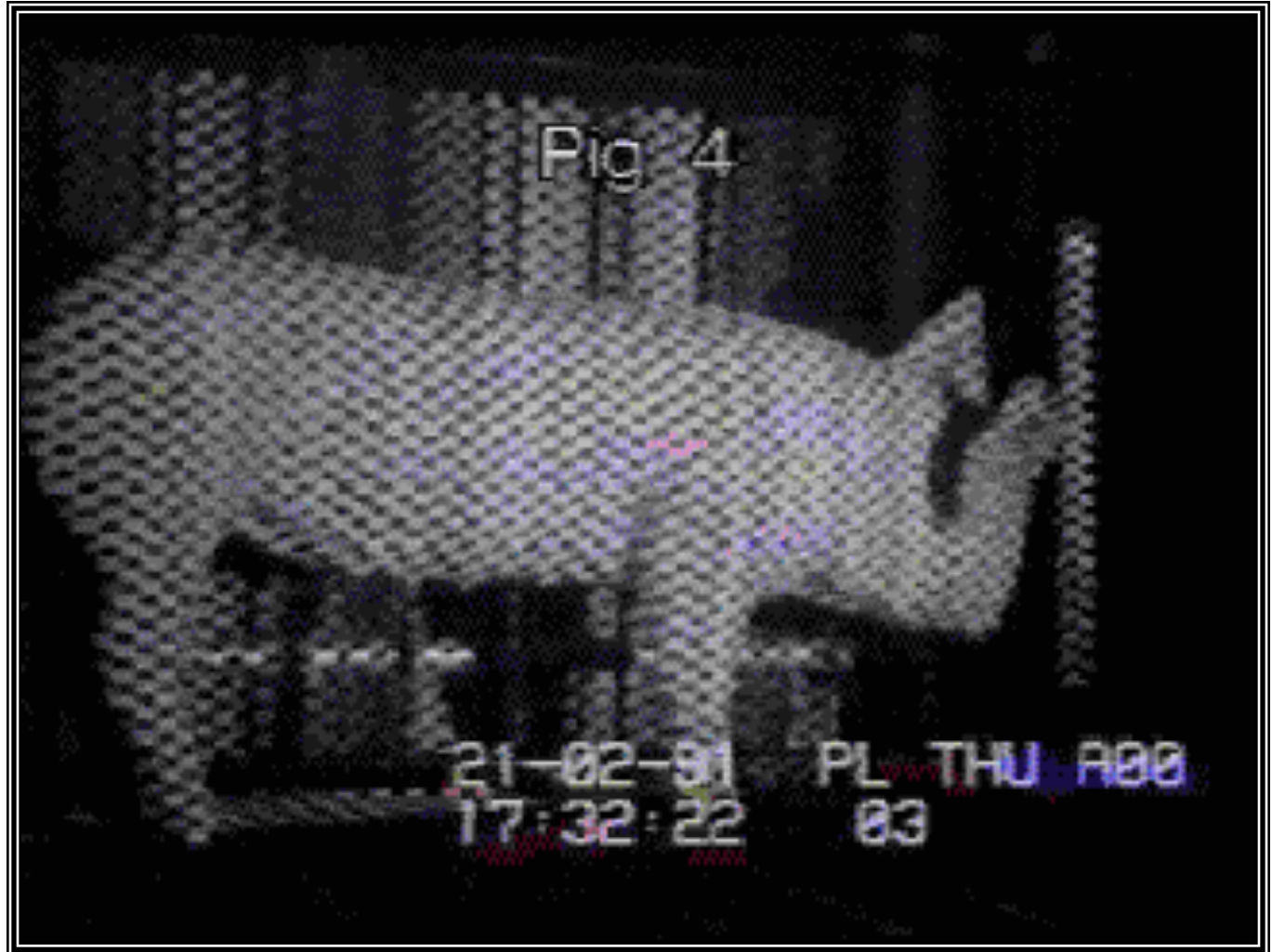

One-shot 3D acquisition

Leuven ShapeCam

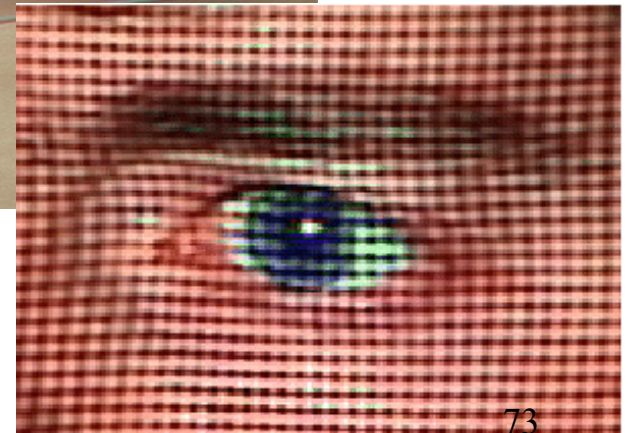

Shape + texture often needed

Higher resolution

Texture is also extracted

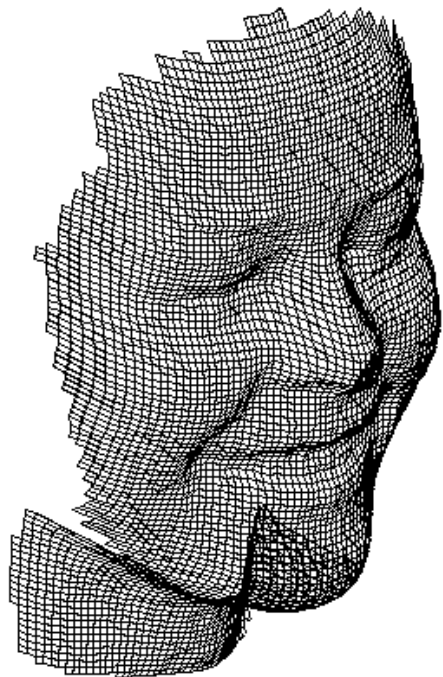

Computer
Vision



James Bond

Die another day

Lara Croft

Thomb
Raider

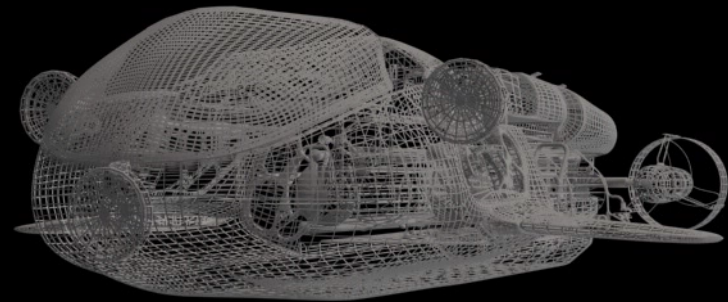

Active triangulation

Recent, commercial example



KINECT
for  XBOX 360.

Kinect 3D camera, affordable and compact solution by Microsoft.

Projects a 2D point pattern in the NIR, to make it invisible to the human eye



Kinect: 9x9 patches with locally unique code



Kinect as one-shot, low-cost scanner

Excerpt from the dense NIR dot pattern:



<http://research.microsoft.com/apps/video/default.aspx?i>

Face animation - input

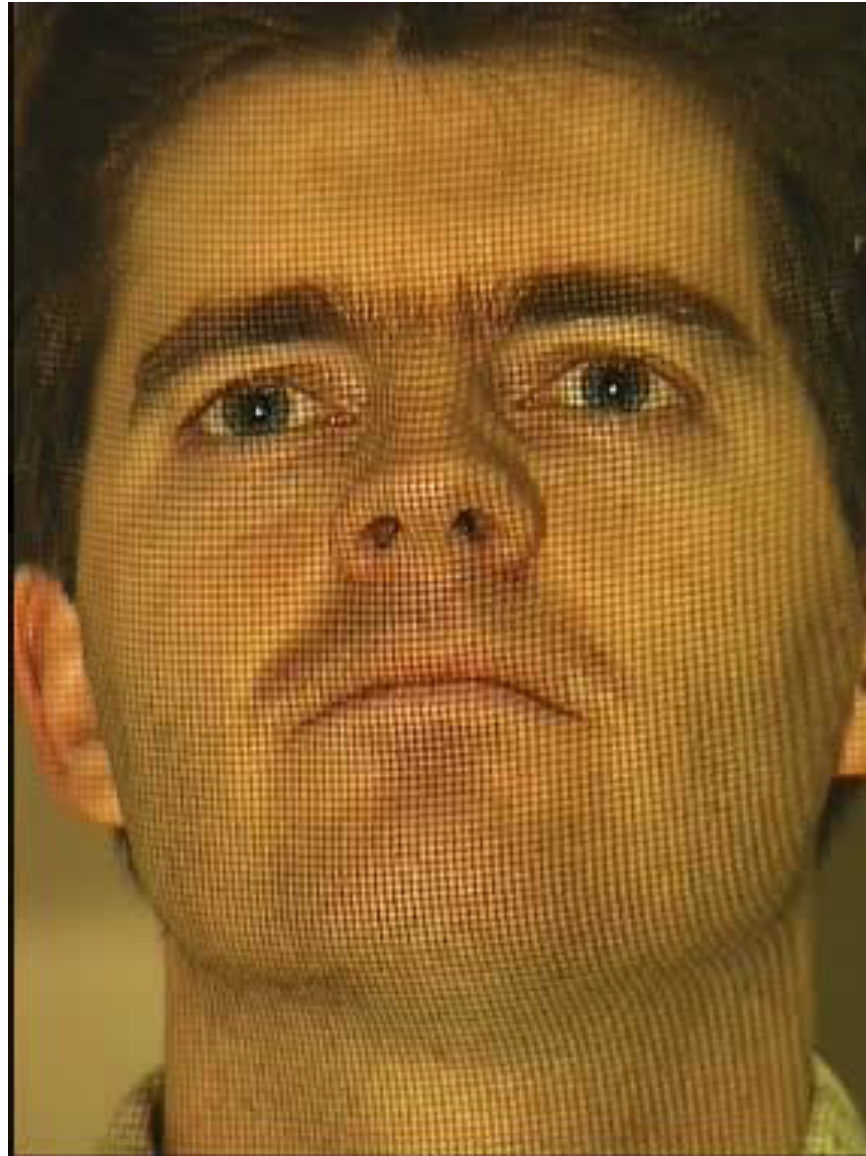

Face animation – replay + effects



Facial motion capture

motion capture for *League of Extraordinary Gentlemen*

SETUP

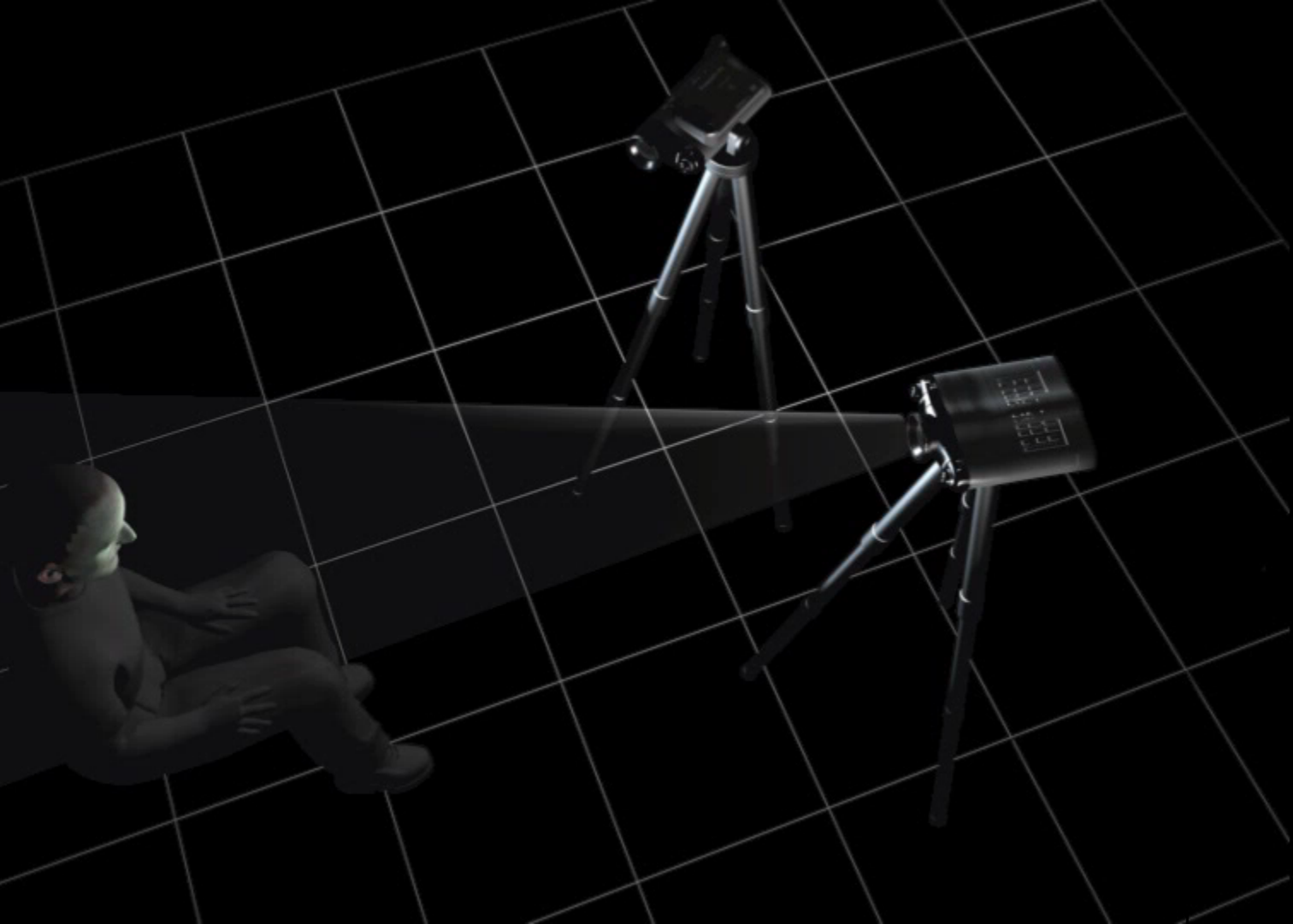

Facial motion capture



COMPUTERCAFE



LC015 Eyetronics
Face Capture Test V01

1 / 291

03 / 11 / 2003

Phase shift

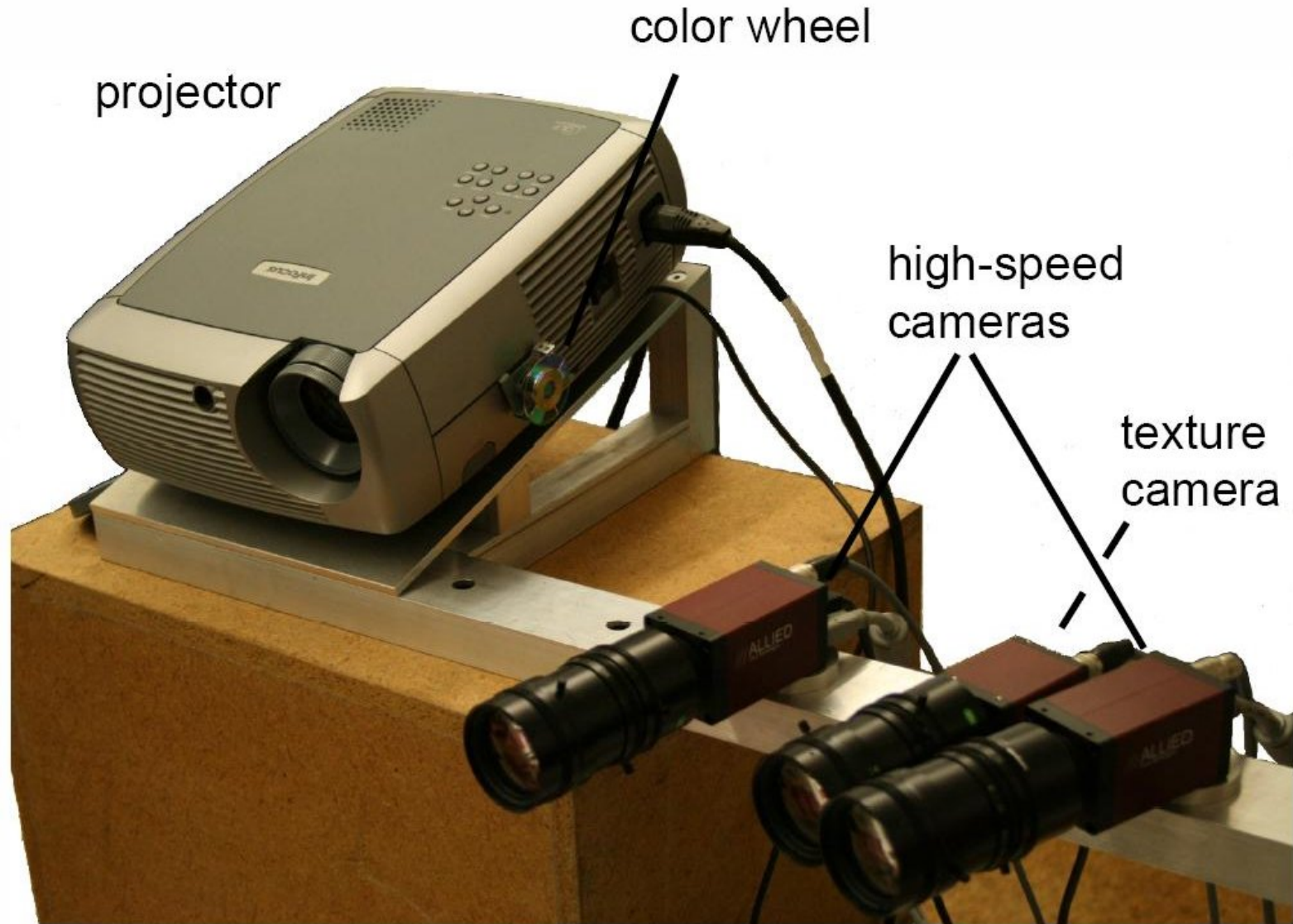

Phase shift

$$I_r = A + R \cos (\phi - \theta)$$

$$I_g = A + R \cos (\phi)$$

$$I_b = A + R \cos (\phi + \theta)$$

1. detect phase from 3 subsequently projected cosine patterns, shifted over 120 degrees
2. unwrap the phases / additional stereo
3. texture is obtained by summing the 3 images / color camera w. slower integration⁸⁴

Phase shift

$$A = \frac{I_r + I_g + I_b}{3}$$

$$\phi = \arctan \left(\tan \left(\frac{\theta}{2} \right) \frac{I_r - I_b}{2I_g - I_r - I_b} \right)$$

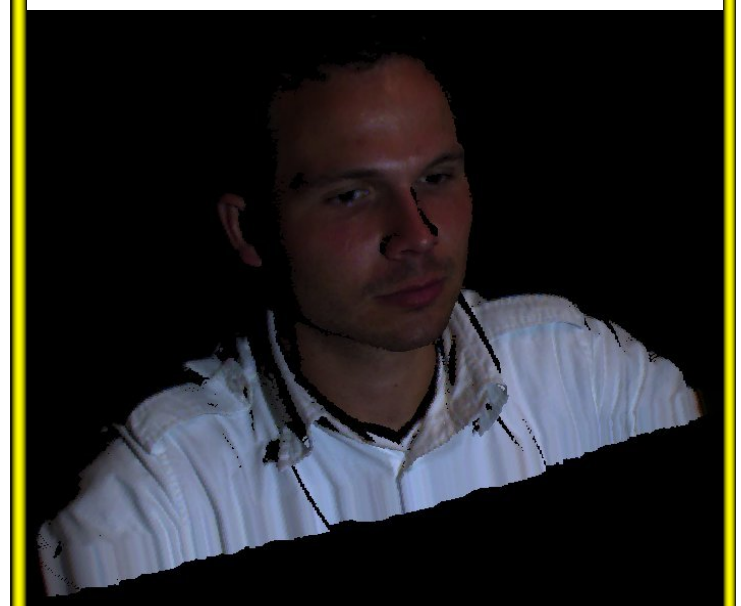

4D acquisition

Motion retargetting, from 3D phase shift scans

Face/Off: Live Facial Puppetry

PaperID 102

3D acquisition taxonomy

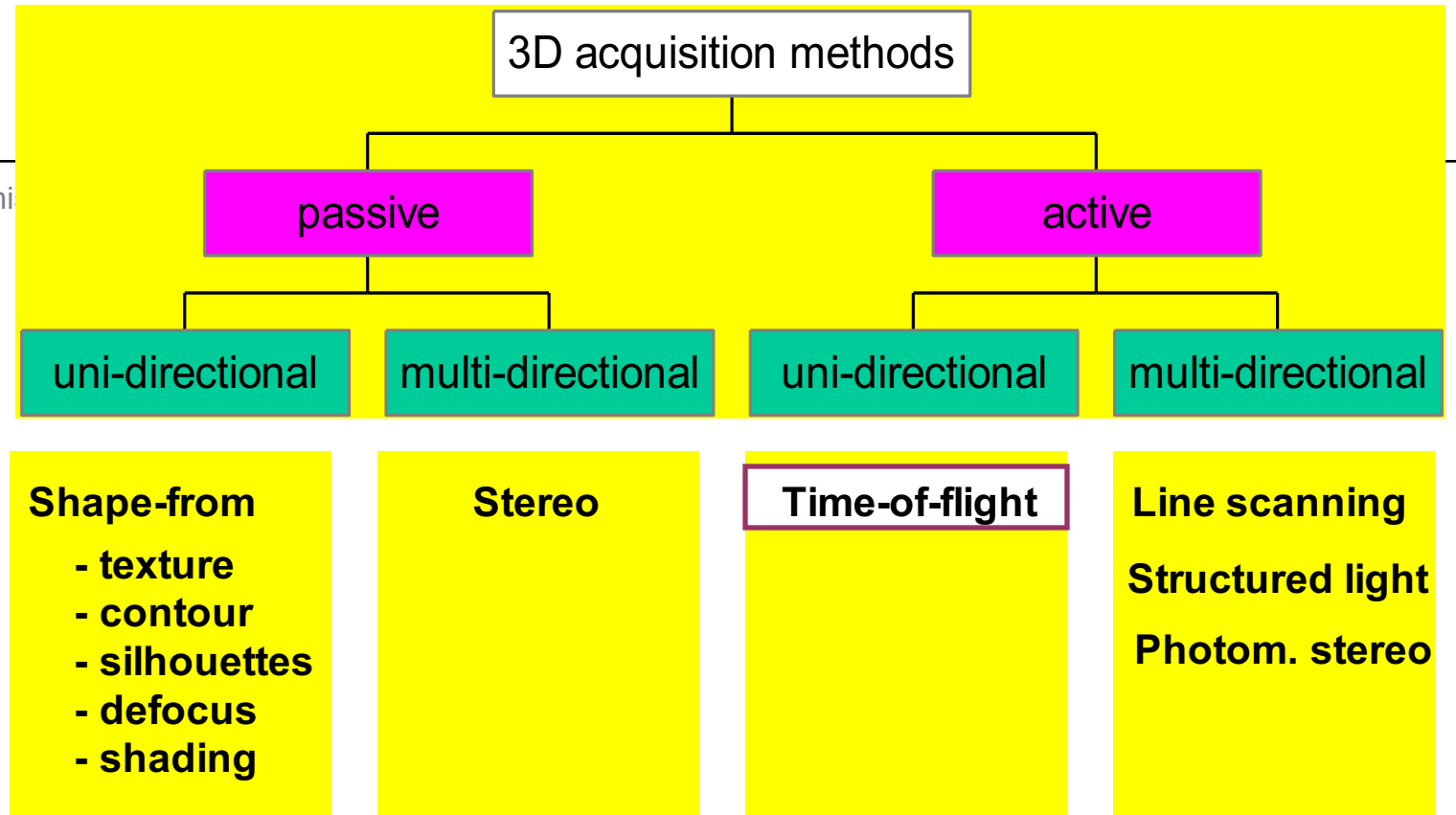

This

Time-of-flight

measurement of the time a modulated light signal needs to travel before returning to the sensor

this time is proportional to the distance

waves :

- | | |
|-------------------------|---------------------------|
| 1. <i>radar</i> | low freq. electromagnetic |
| 2. <i>sonar</i> | acoustic waves |
| 3. <i>optical radar</i> | optical waves |

working principles :

1. pulsed
2. phase shifts



Time-of-flight

Example 1: Cyrax



Example 2: Riegl



Time-of-flight: example

Cyrax™

**3D Laser Mapping
System**

Cyrax

Accurate, detailed, fast measuring

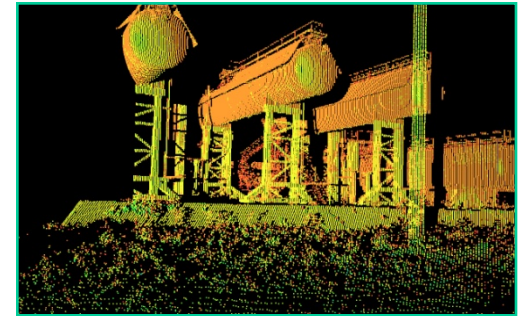
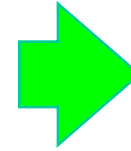
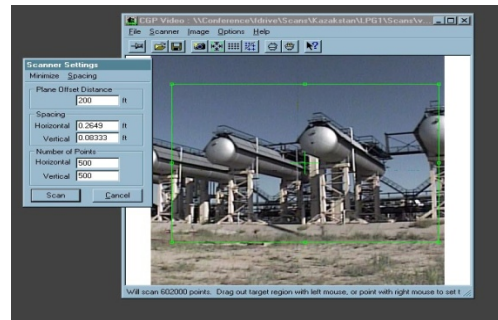

2D / 3D CAD

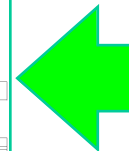
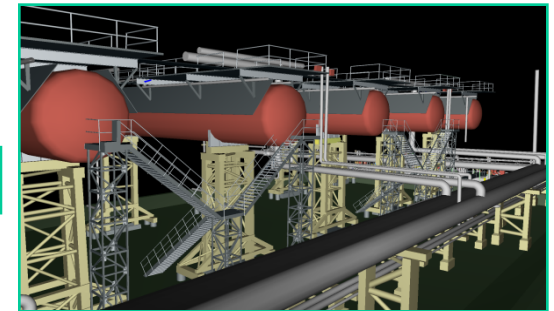
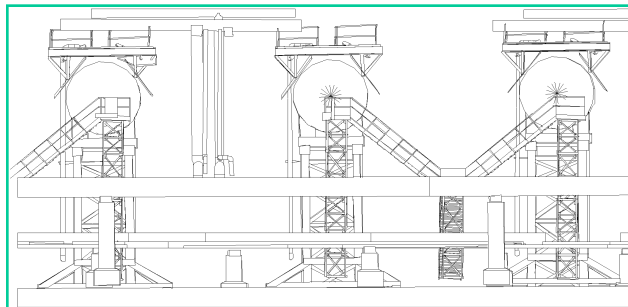

Integrated modeling

Cyrax

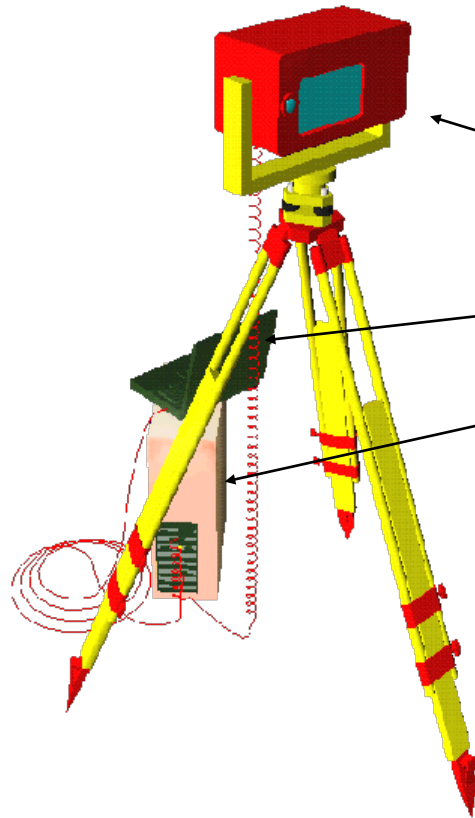

- 3 Components
 - Laser Scanner
 - Laptop Computer & Software
 - Electronics & Power Supply
- Field Portable

Pulsed laser (time-of-flight)

**No reflectors
needed**

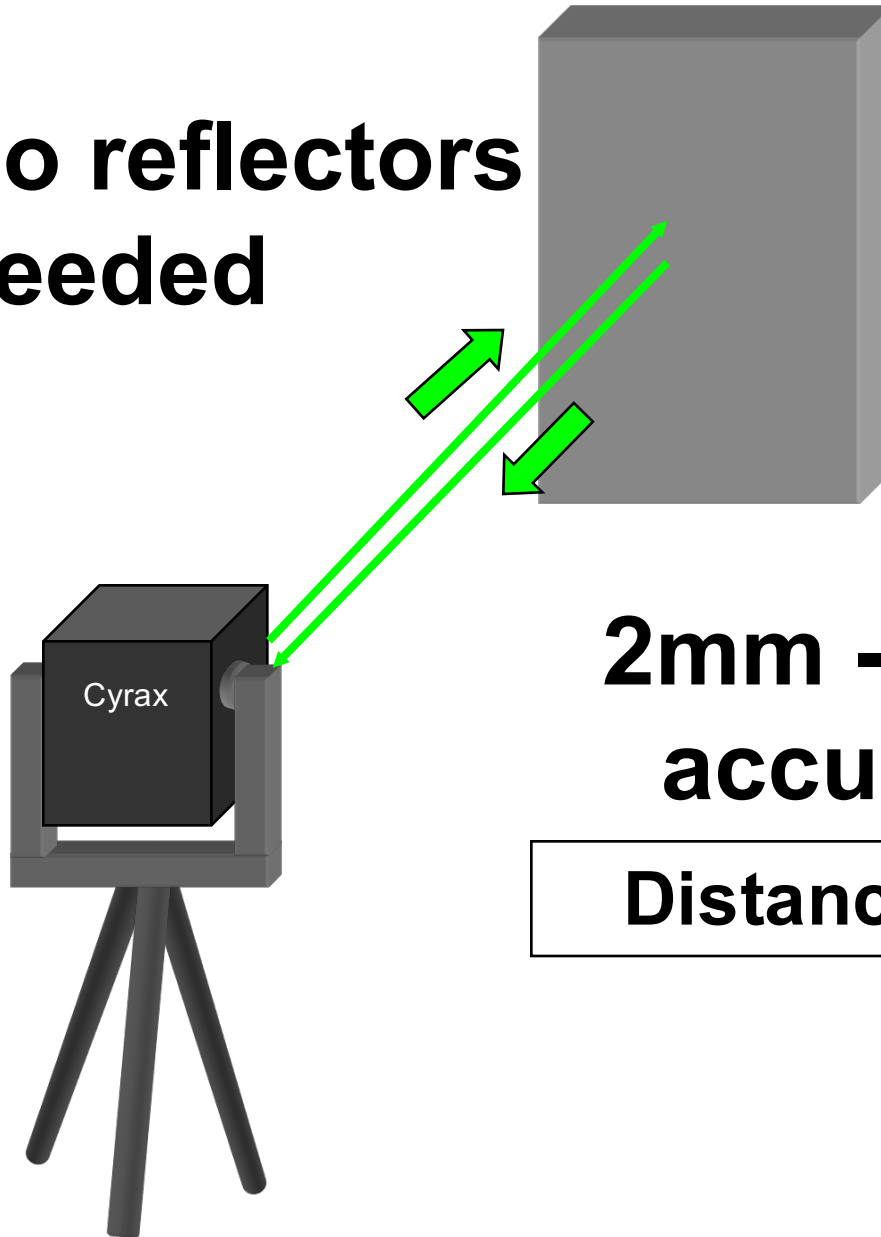

**2mm - 6mm
accuracy**

$$\text{Distance} = C \times \Delta T \div 2$$

Laser sweeps over surface

800 pts/sec

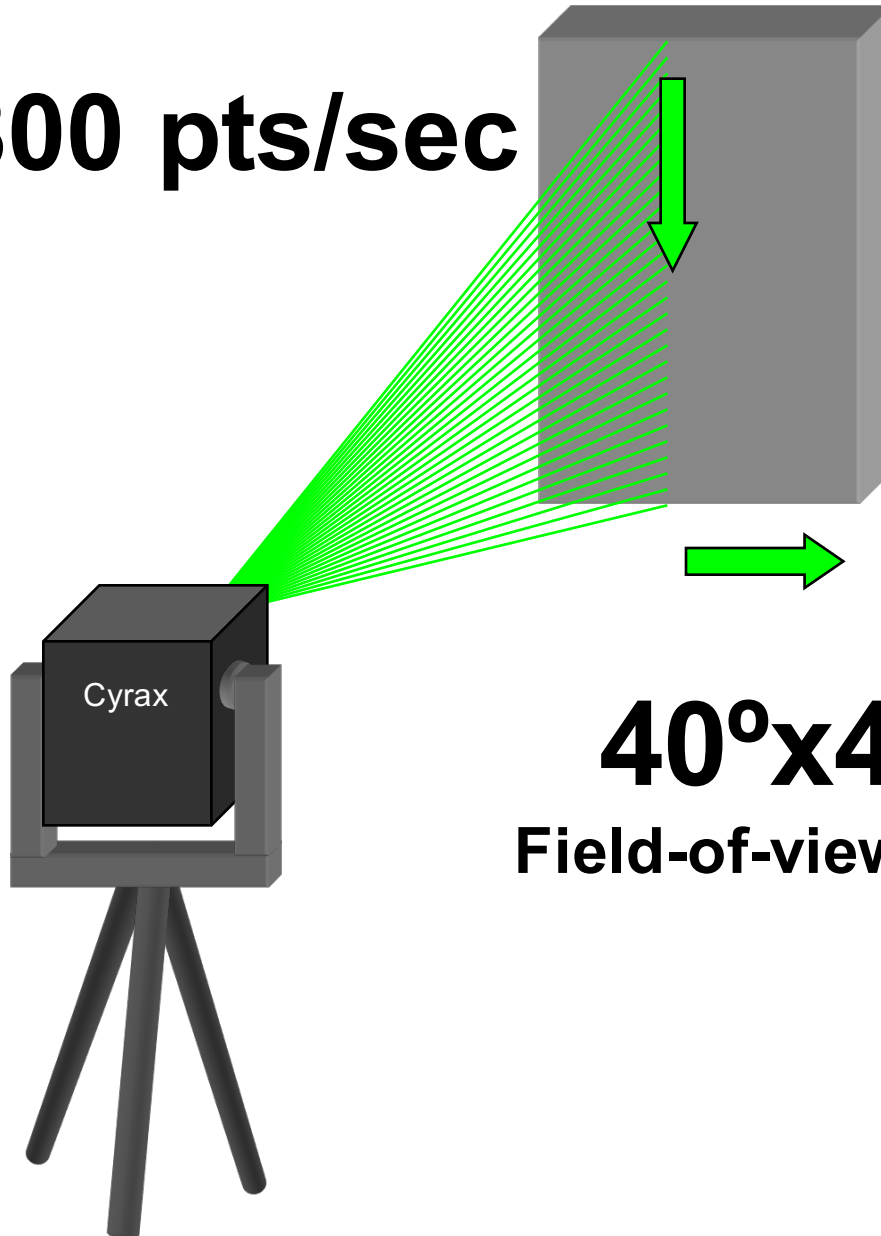

2mm min
pt-to-pt
spacing

40°x40°
Field-of-view (max)

**Up to
100m range
(50m rec)**

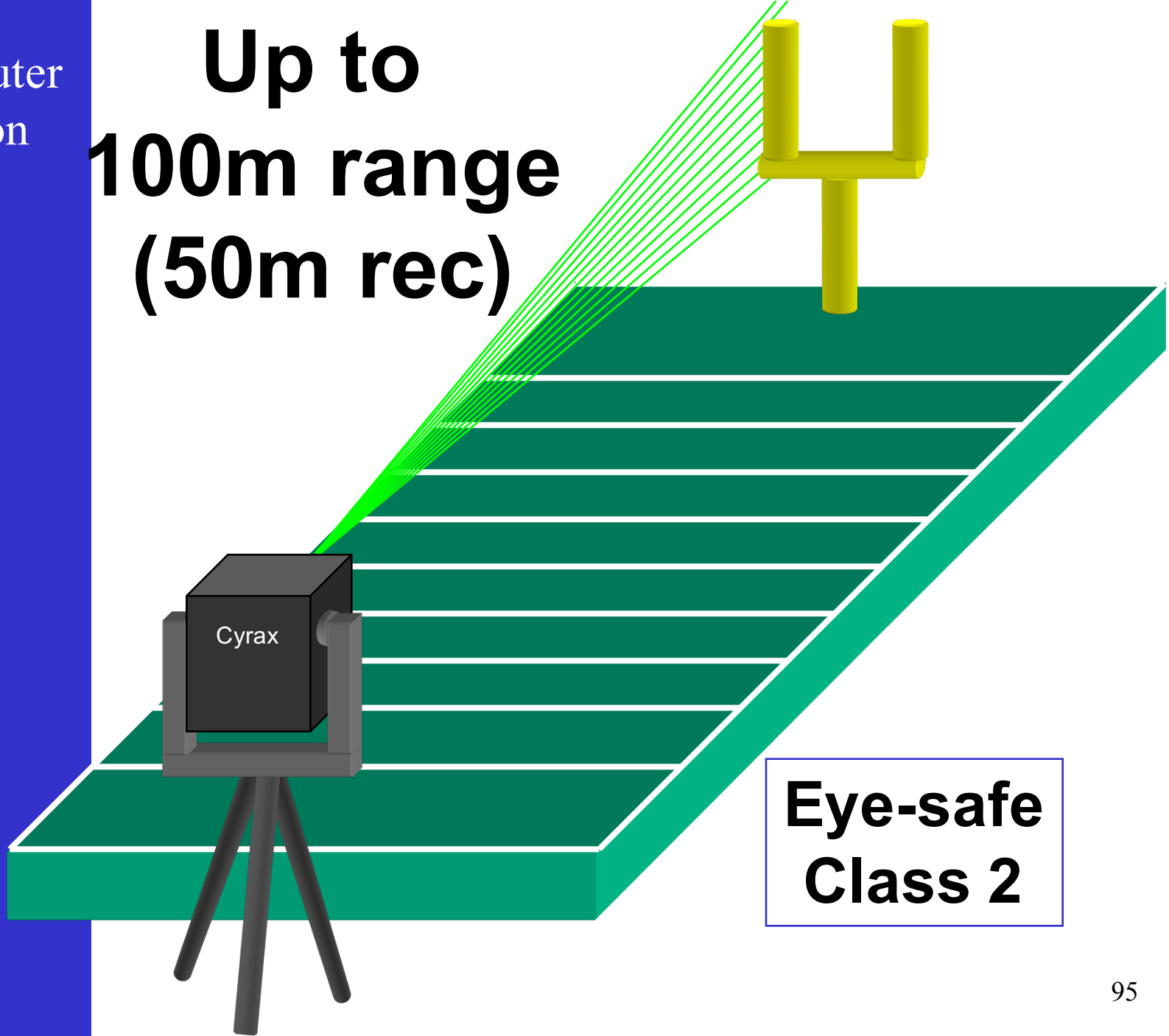

**Eye-safe
Class 2**

Cyrax is also a **visualization** tool

Cyrax detects the intensity of each reflected laser pulse and **colors** it



Step 1: Target the structure

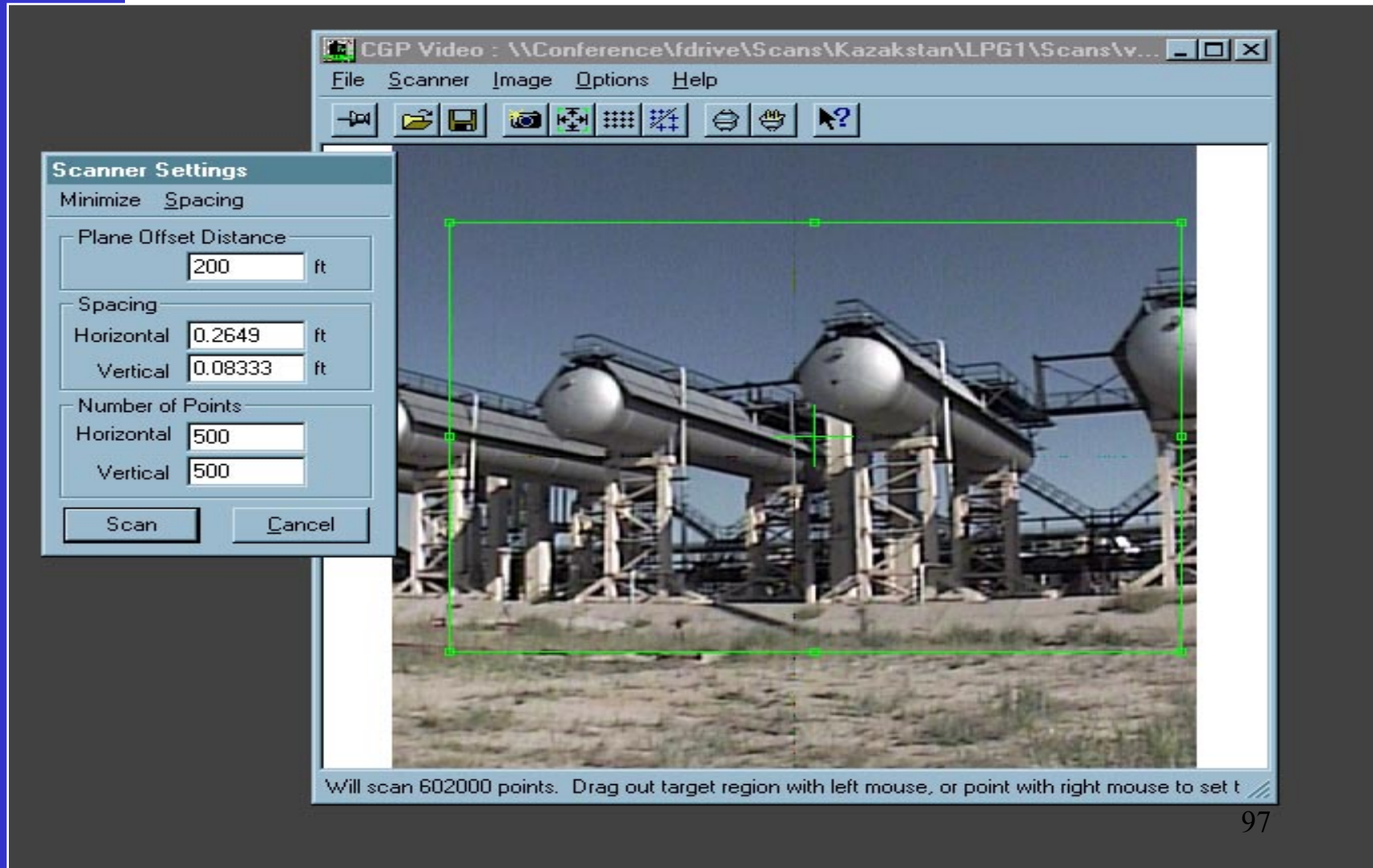

Step 2: Scan the structure

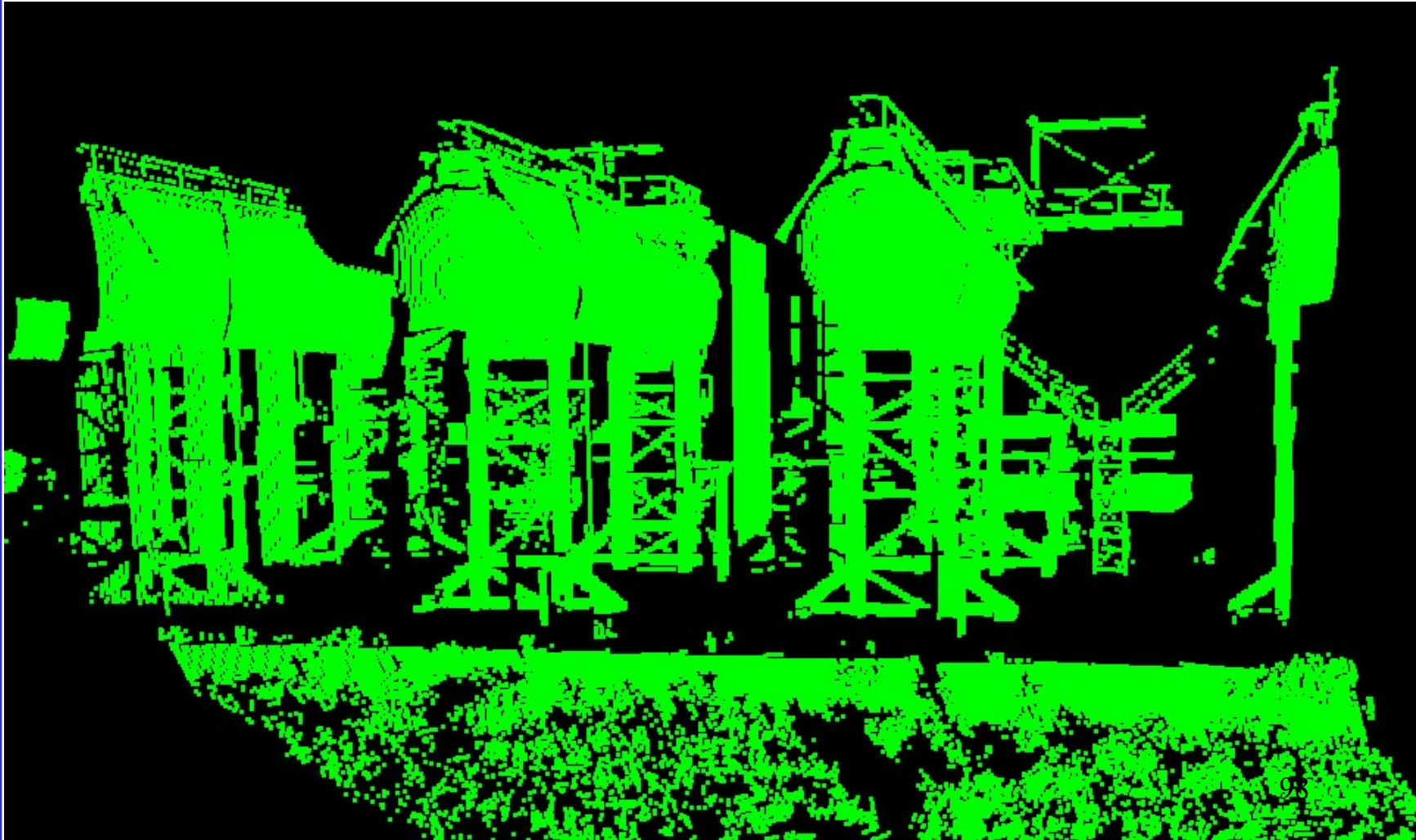

Step 3: Color the points

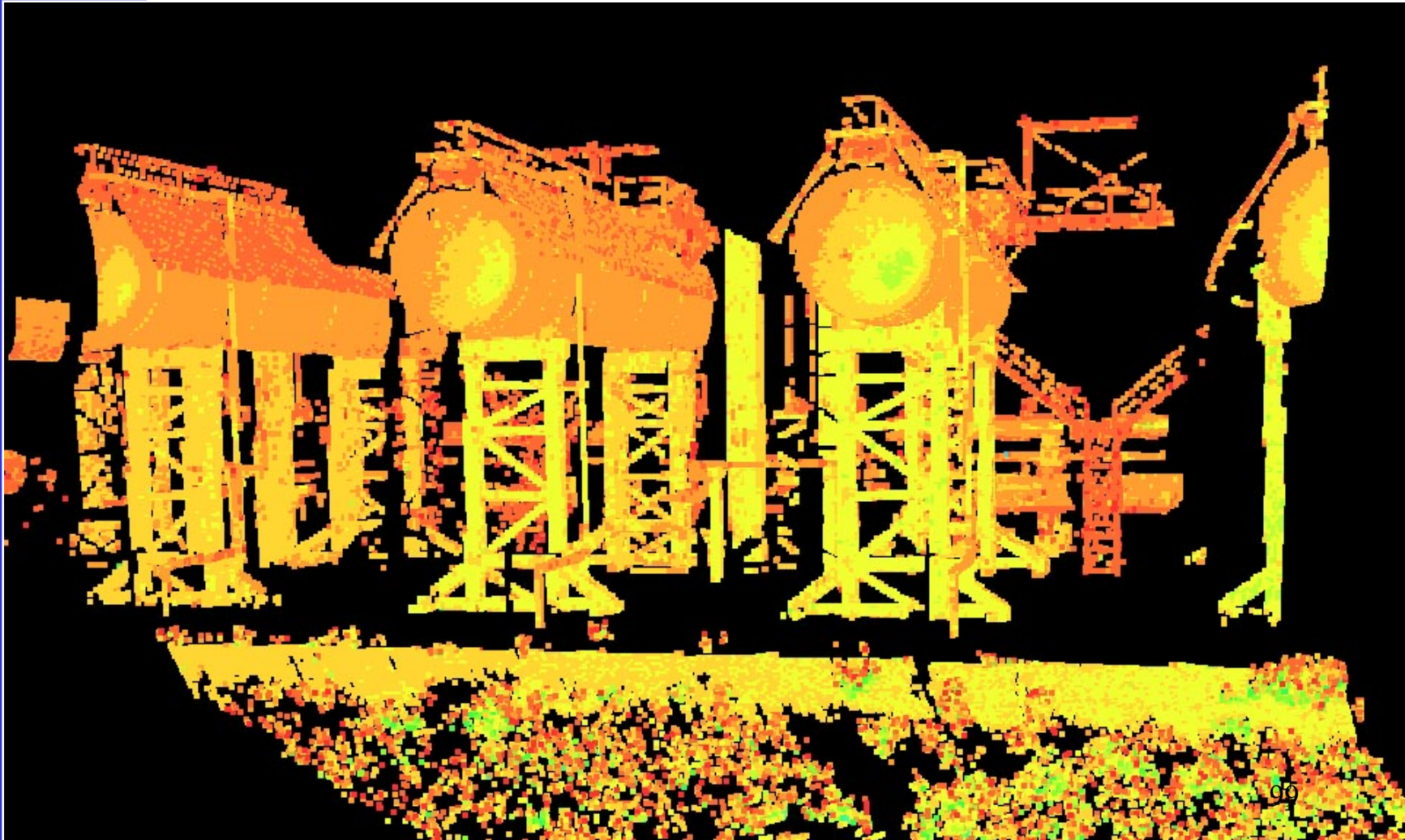

Step 4: Model fitting in-the-field

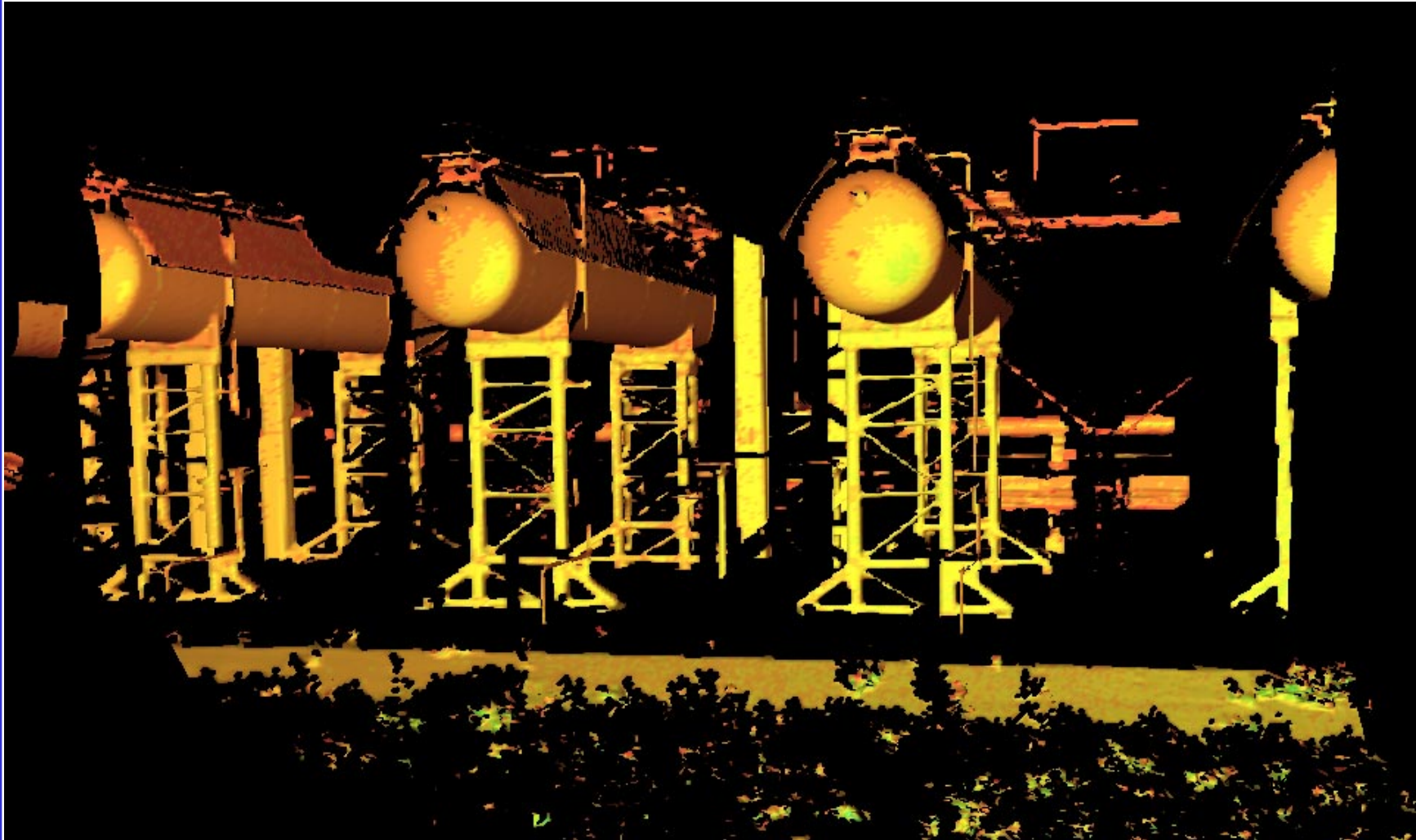

Result

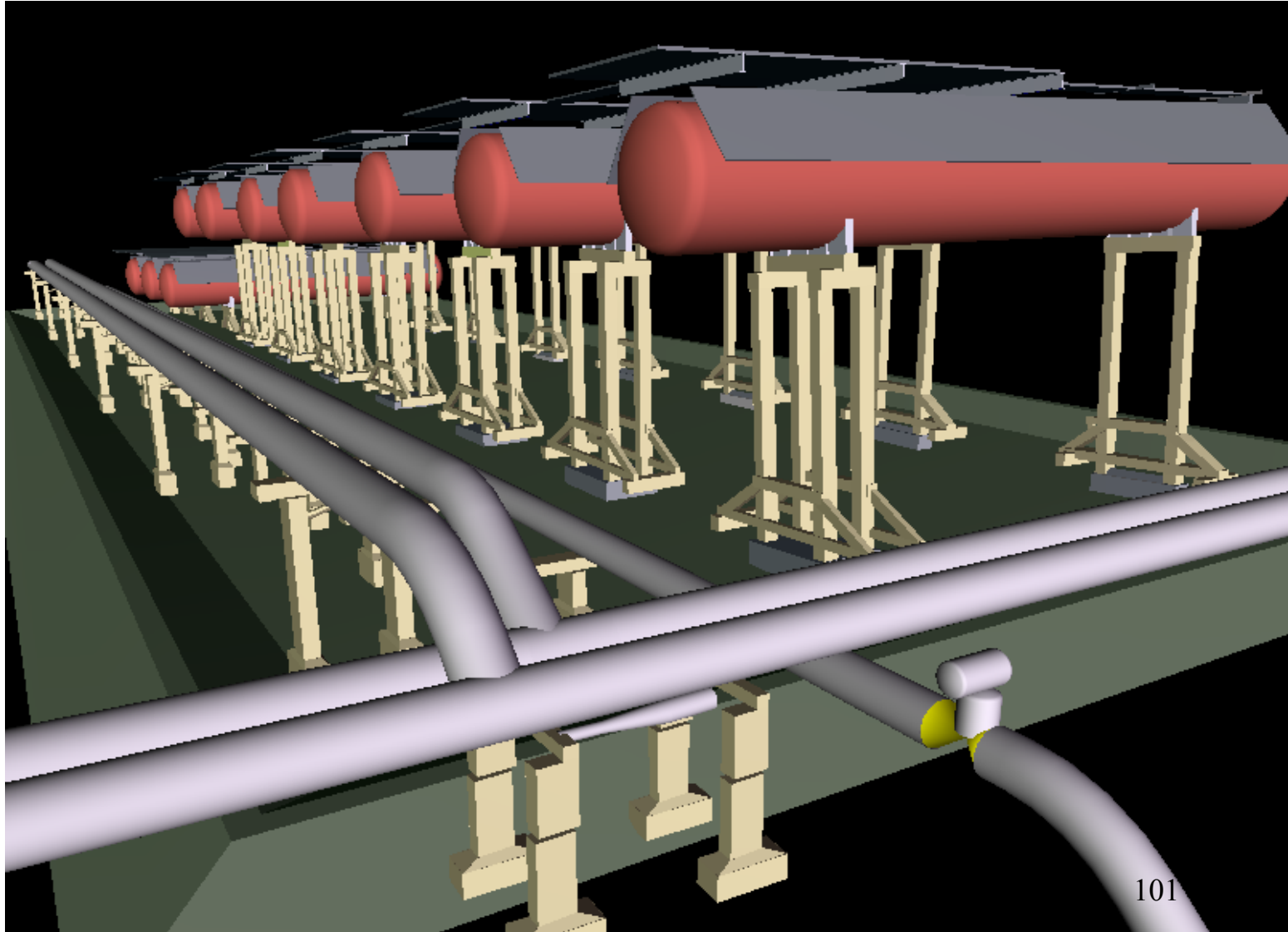

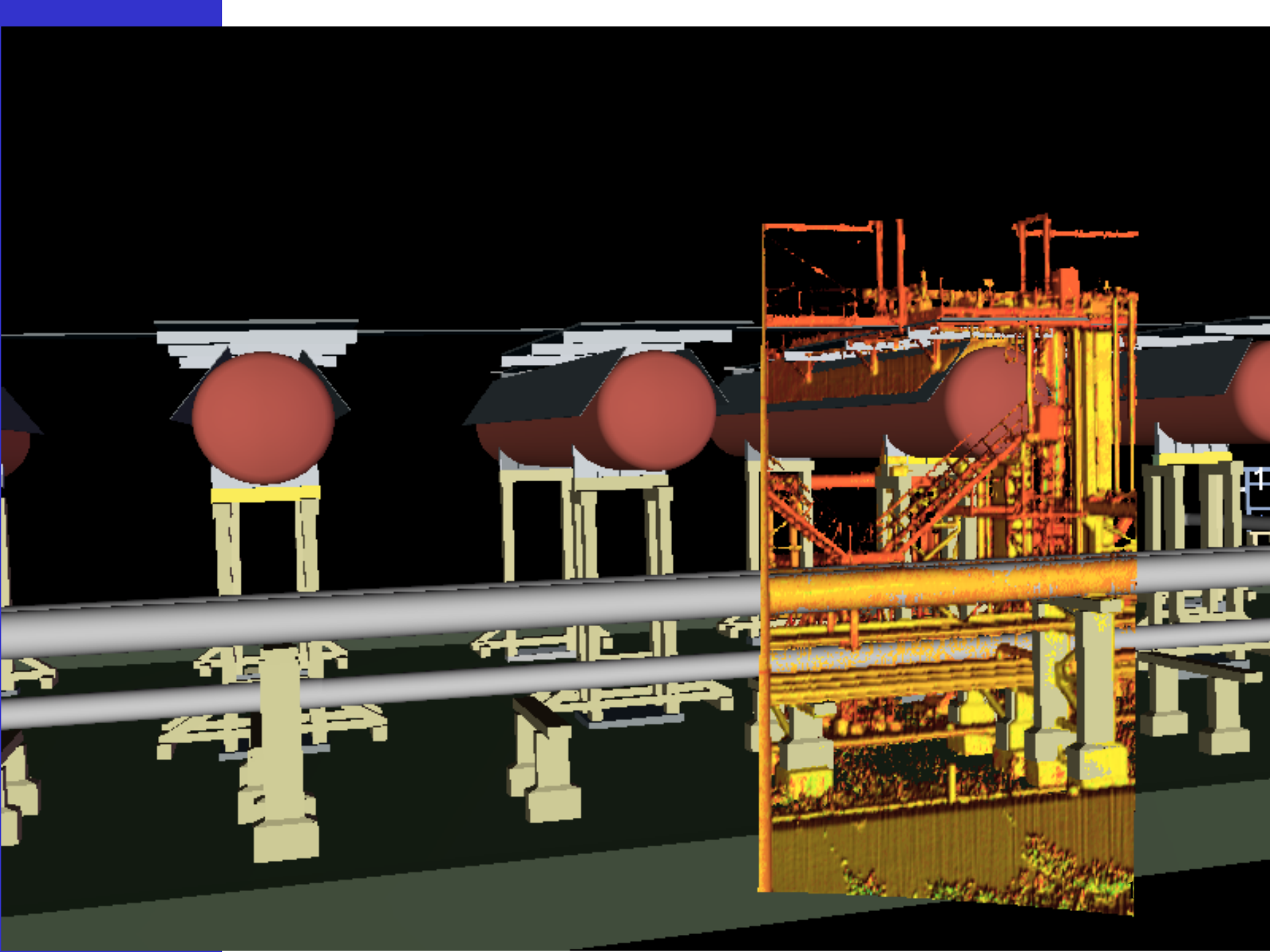

Project: As-built of Chevron hydrocarbon plant



- 400'x500' area
- 10 vessels; 5 pumps
- 6,000 objects
- 81 scans from 30 tripod locations
- *Cyrax* field time = 50 hrs

Cost Benefits

Measuring & modeling

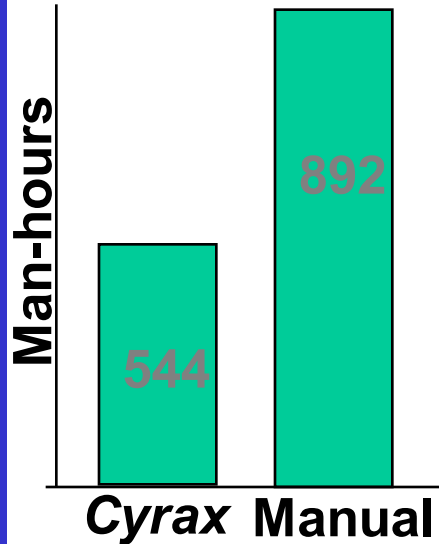

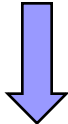
- 
- Greater detail & no errors
 - Higher accuracy
 - Fewer construction errors
 - 6 week schedule savings

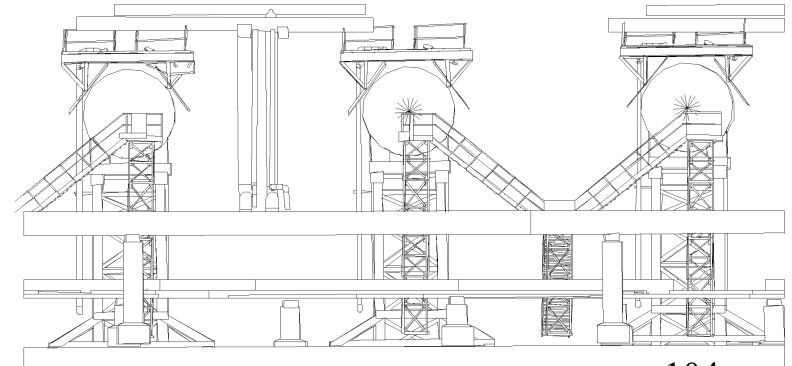
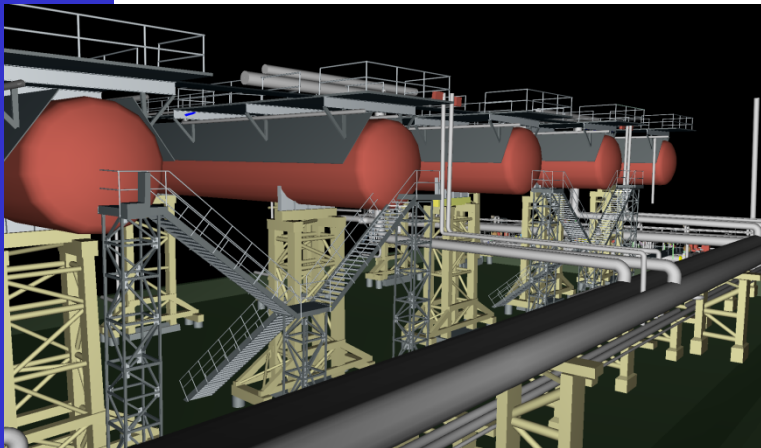

Application

Modeling movie sets

STARSHIP TROOPERS



Lidar data with Riegl LMS-Z390i



Comparison Lidar - passive

3-D Reconstruction based on

Multi-View Stereo

LIDAR Measurements



3D acquisition taxonomy

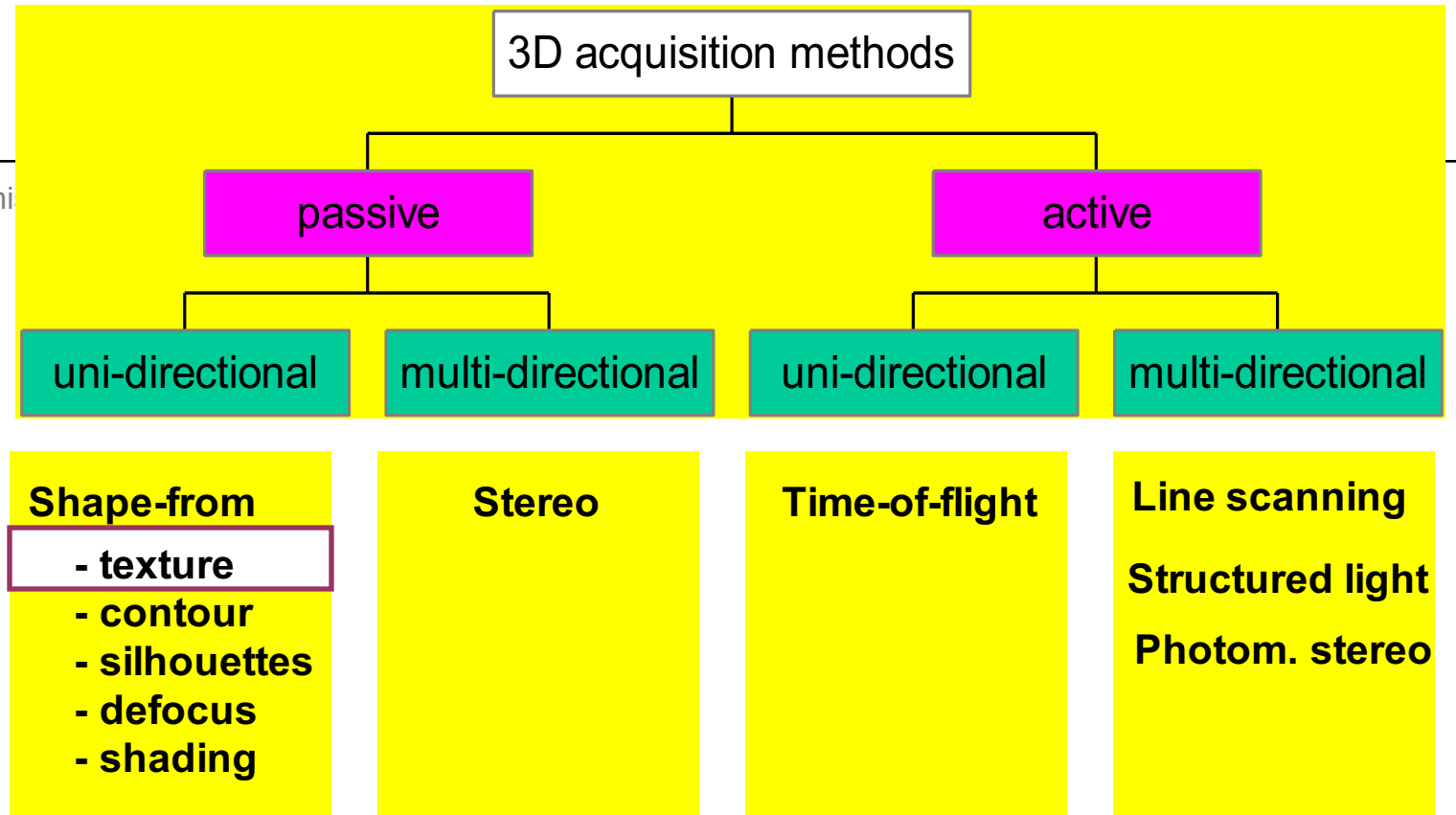

This

Shape-from-texture

assumes a slanted and tilted surface to have a homogeneous texture

inhomogeneity is regarded as the result of projection

e.g. anisotropy in the statistics of edge orientations



orientations deprojecting to maximally isotropic texture



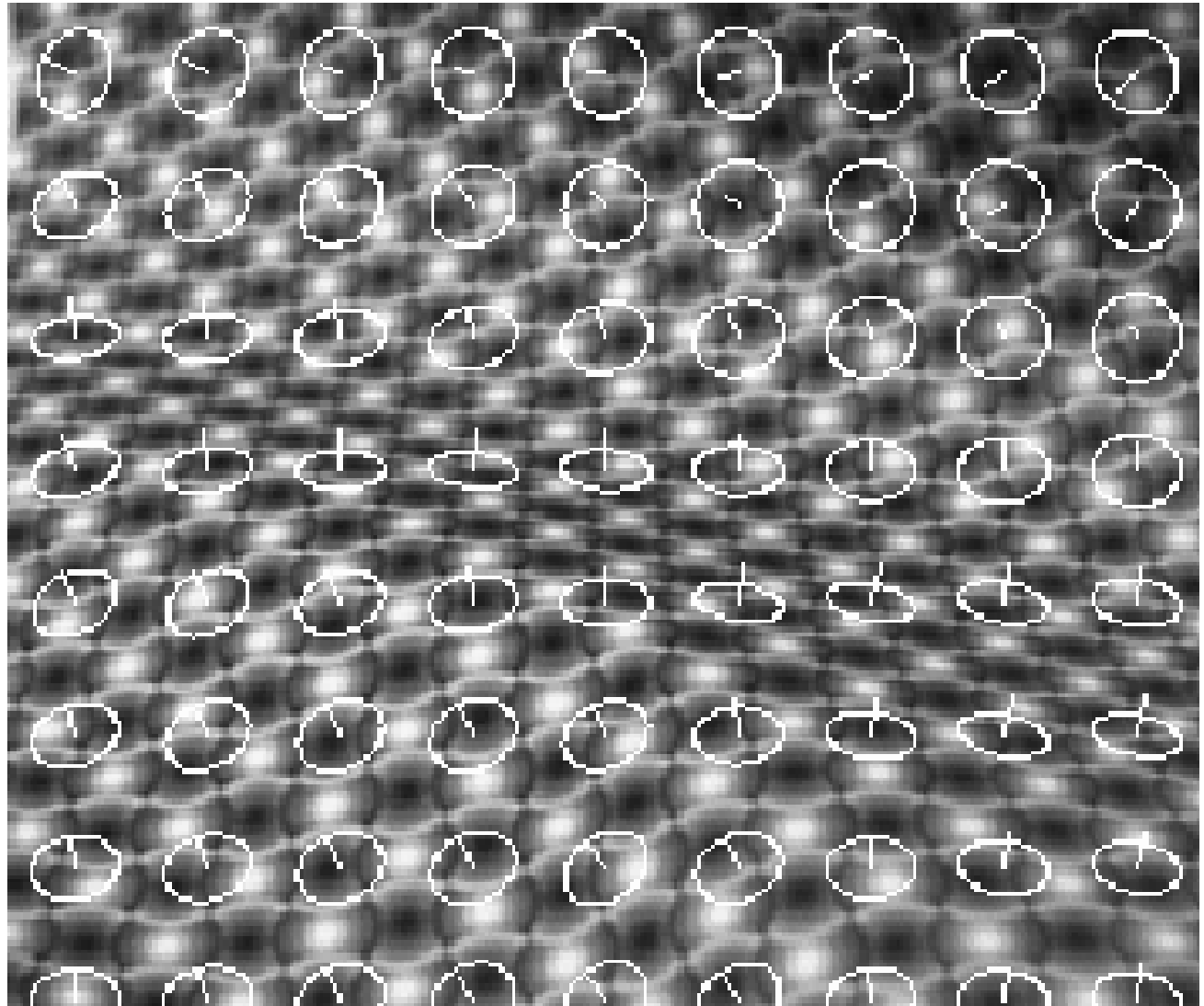

3D acquisition taxonomy

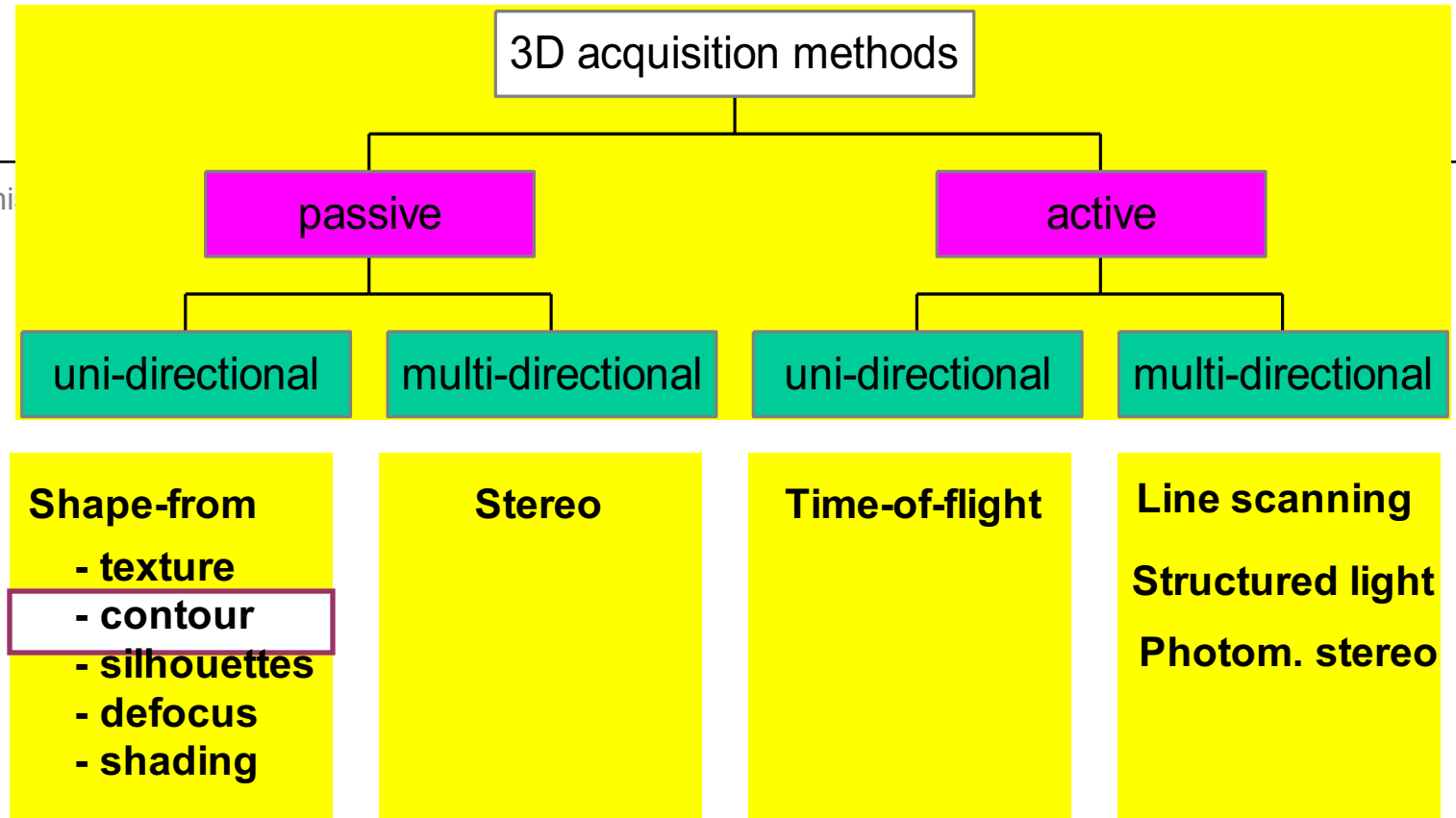

This

Shape-from-contour

makes assumptions about contour shape

E.g. the maximization of area over perimeter squared (compactness)

ellipse \Downarrow → circle

E.g. assumption of symmetry

Symmetric contours \Downarrow → surface of revolution



Shape-from-contour

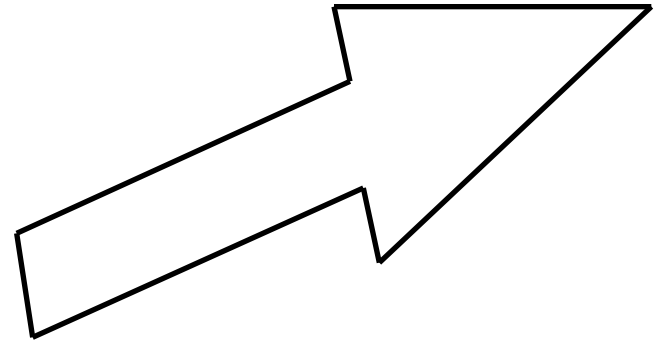
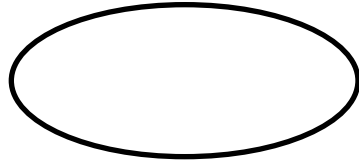

3D acquisition taxonomy

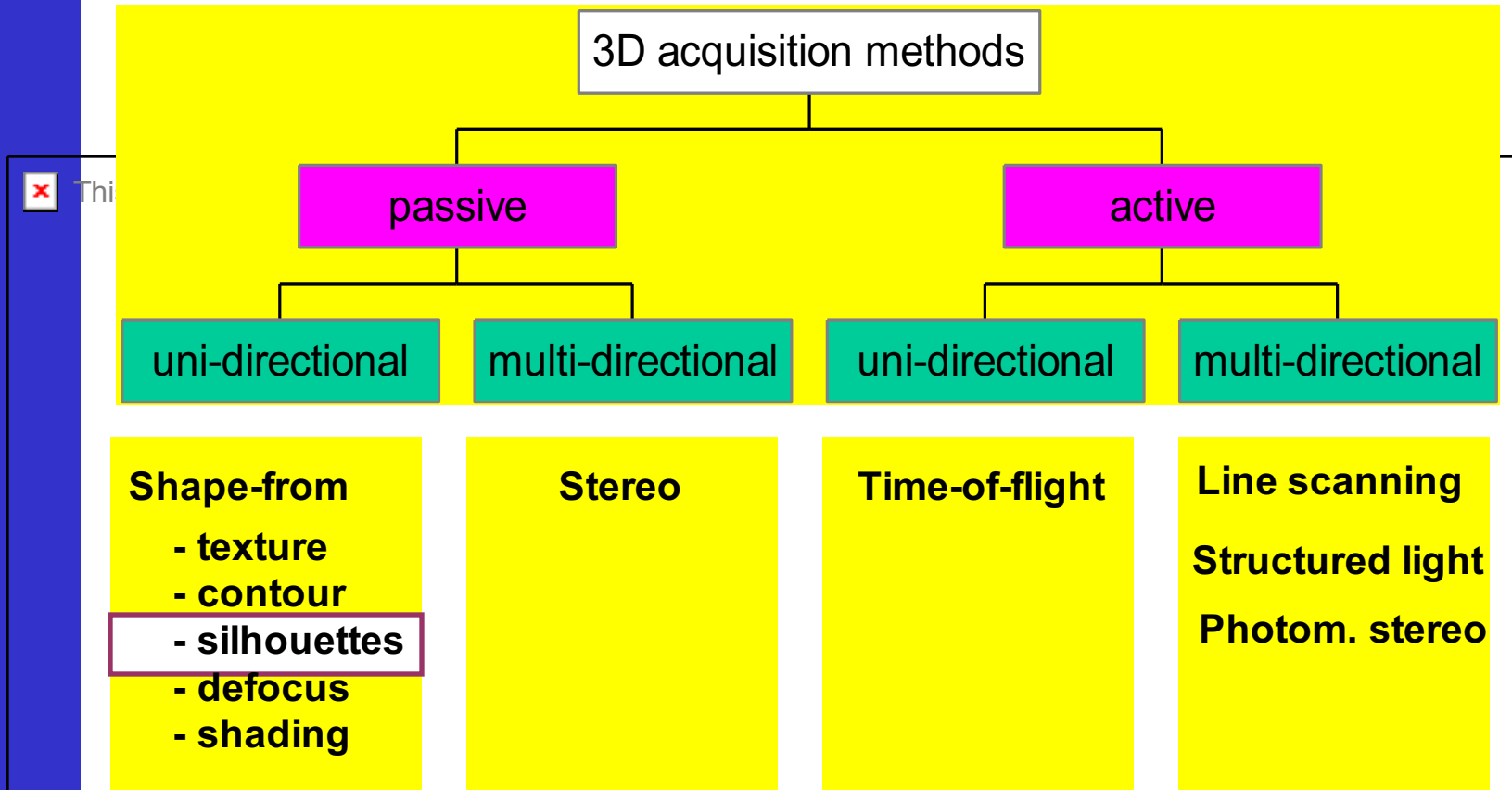

Shape-from-silhouettes

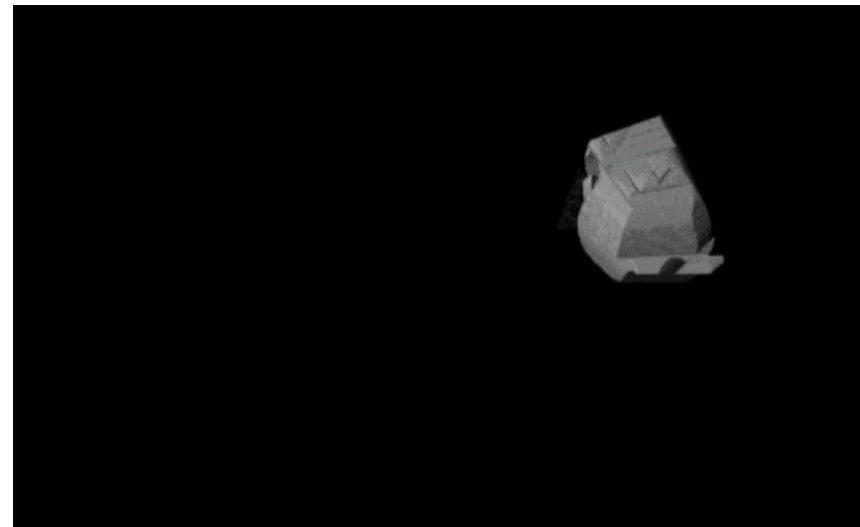
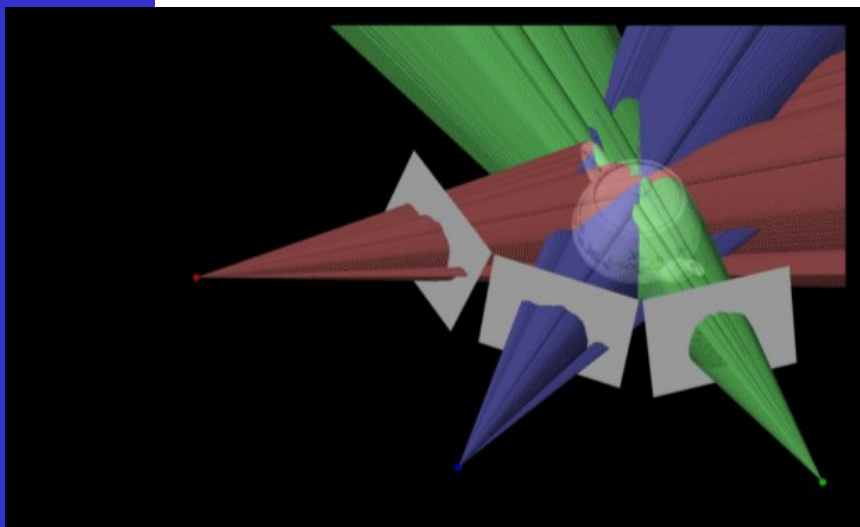
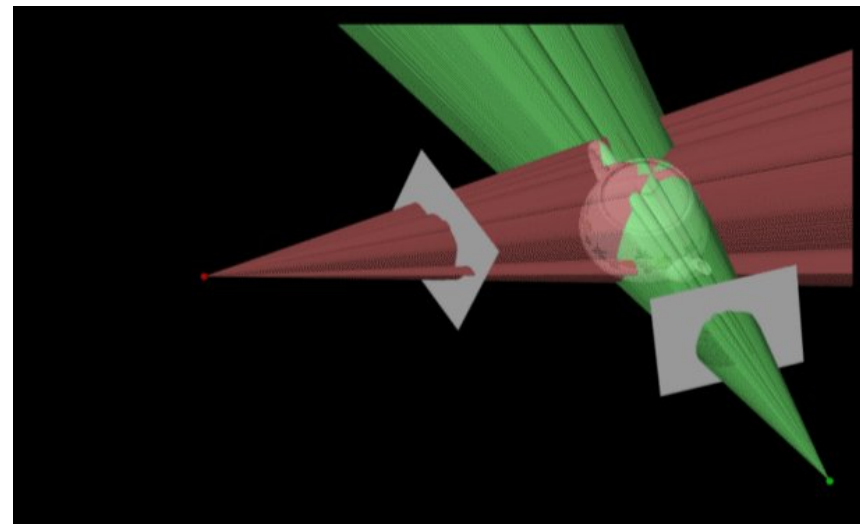
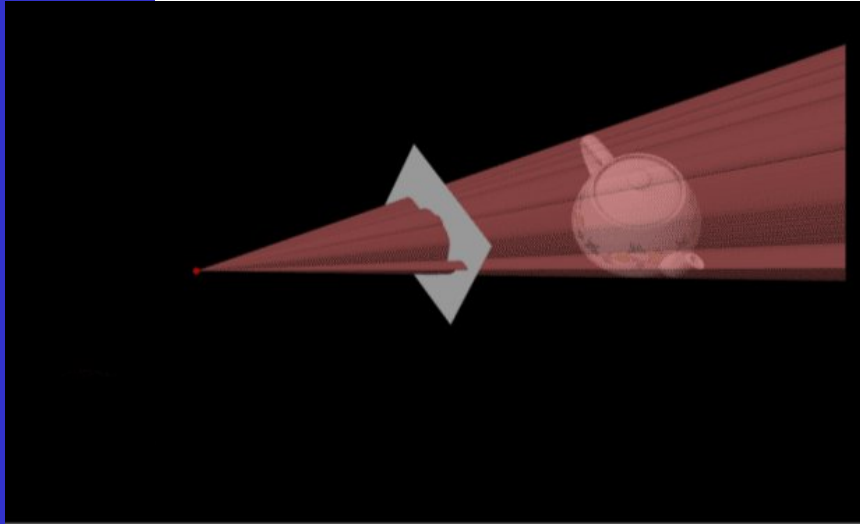

Shape from silhouettes - uncalibrated

tracking of turntable rotation

- volumetric modeling from silhouettes
- triangular textured surface mesh



Turntable sequence

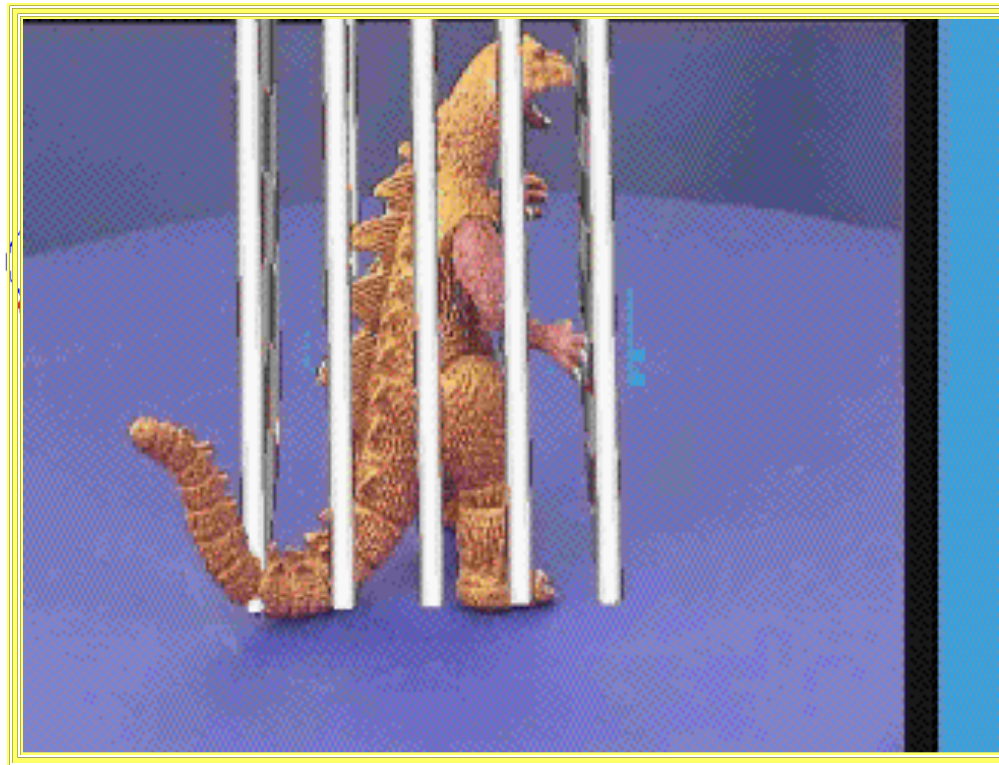

Camera tracking



*VRML model*¹¹⁶

Computer Vision

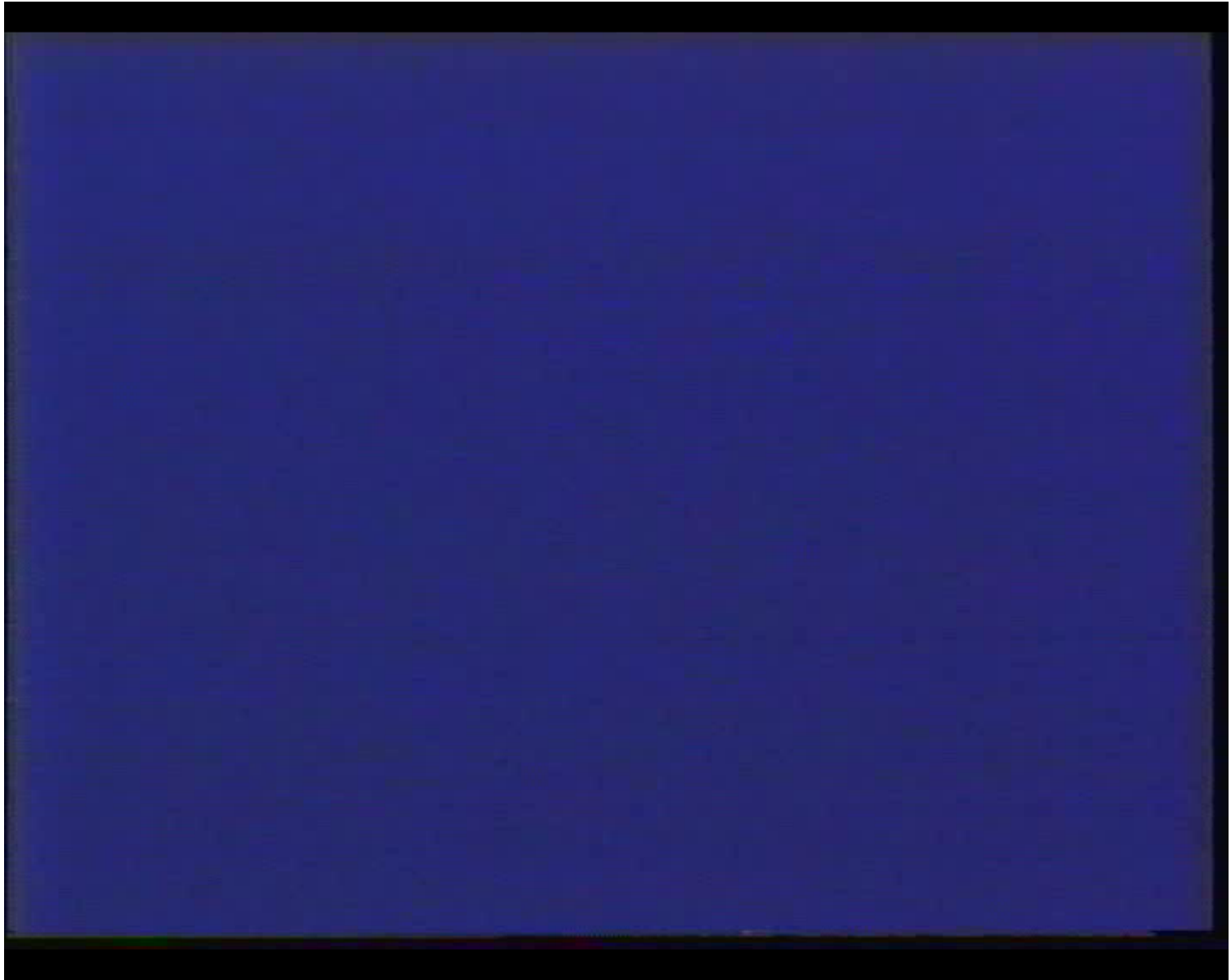

Outdoor visual hulls



Outdoor visual hulls

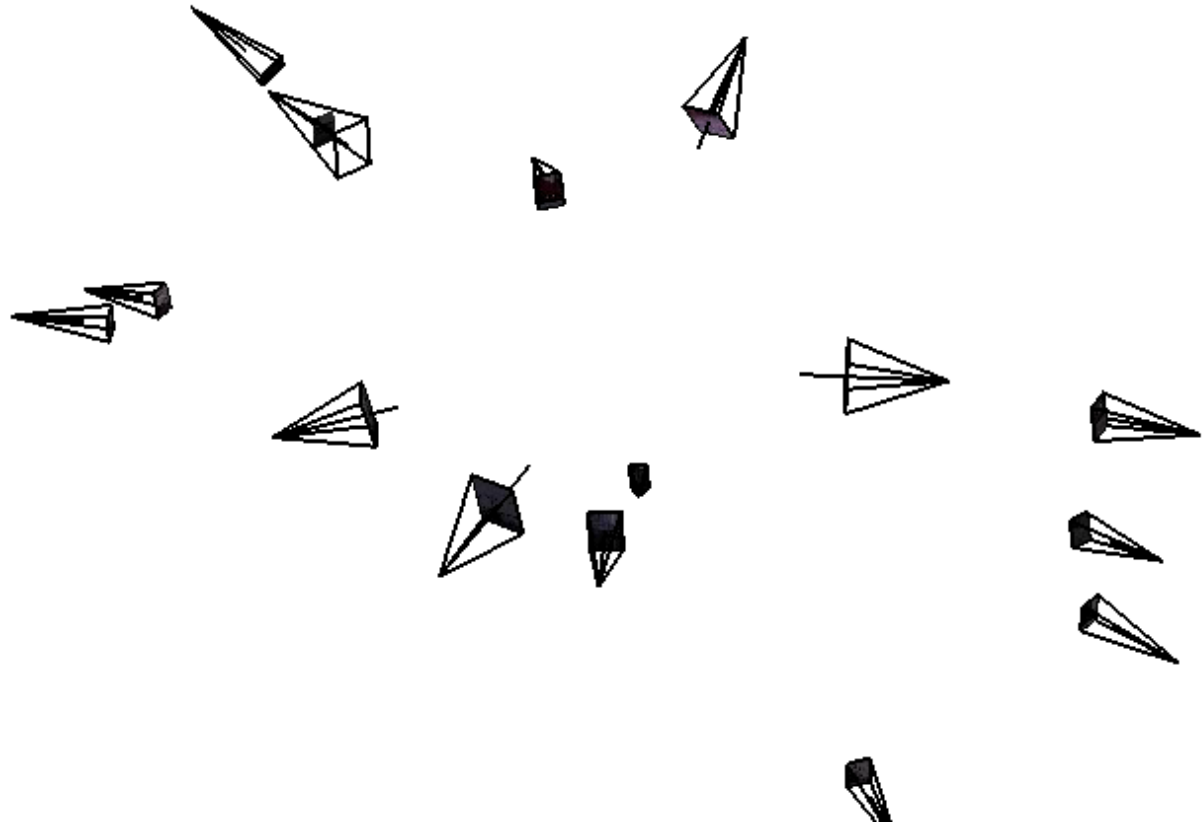

3D acquisition taxonomy

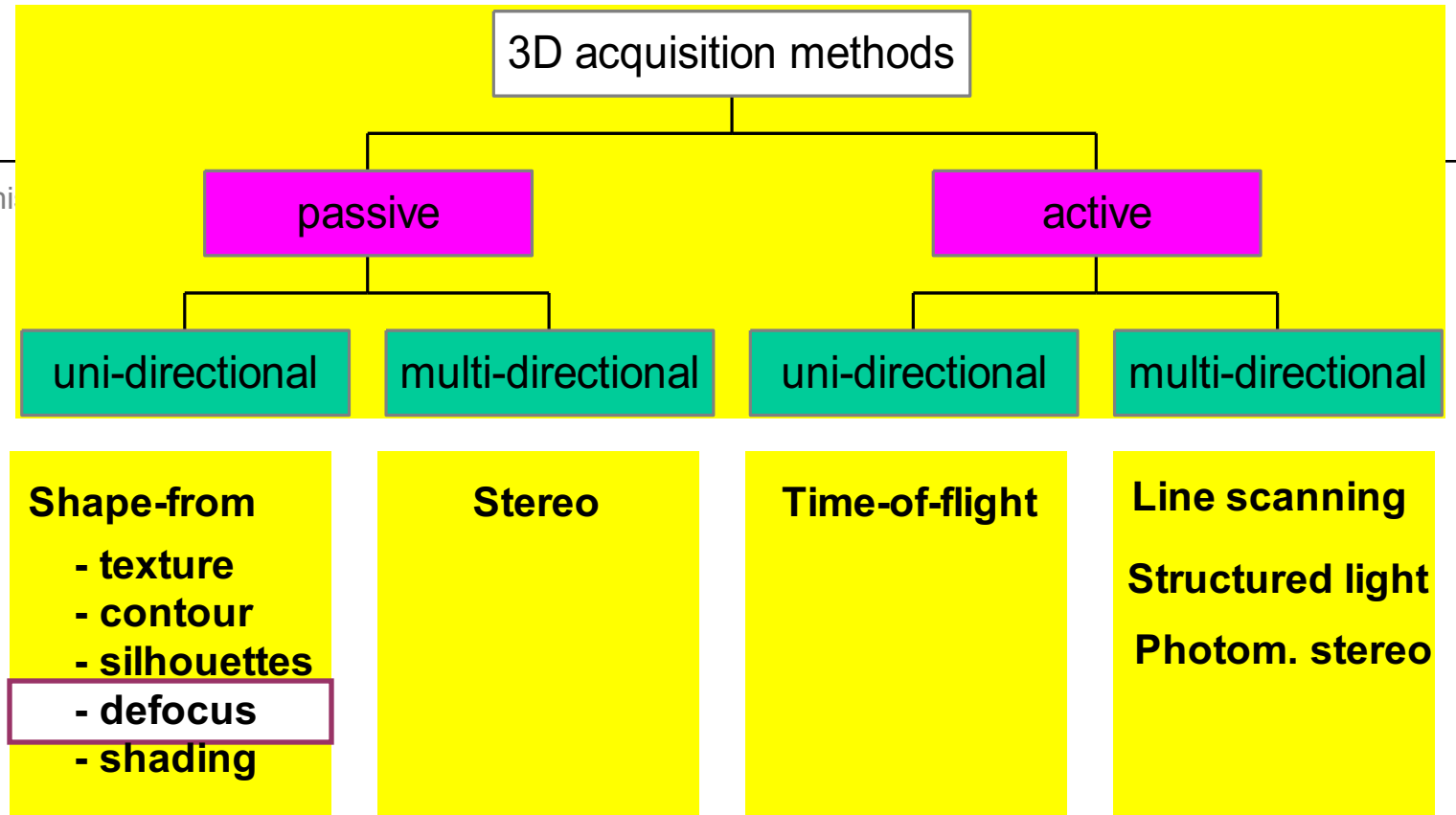

**REAL-TIME
FOCUS RANGE SENSOR**

SHREE K. NAYAR

MASAHIRO WATANABE

MINORI NOGUCHI

COLUMBIA UNIVERSITY

3D acquisition taxonomy

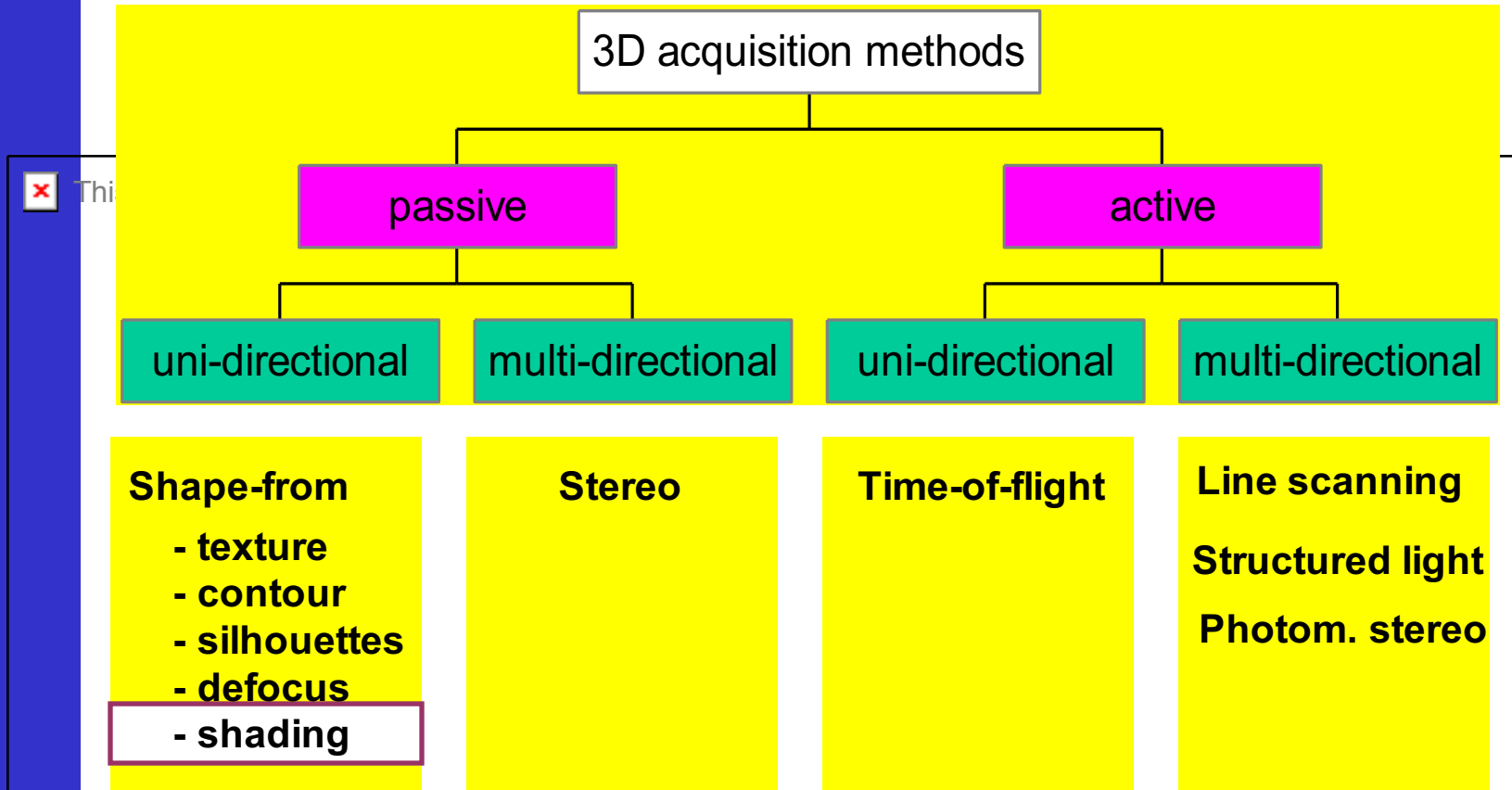

Shape-from-shading

Uses directional lighting, often with known direction

local intensity is brought into correspondence with orientation via *reflectance maps*

orientation of an isolated patch cannot be derived uniquely

extra assumptions on surface smoothness and known normals at the rim



3D acquisition taxonomy

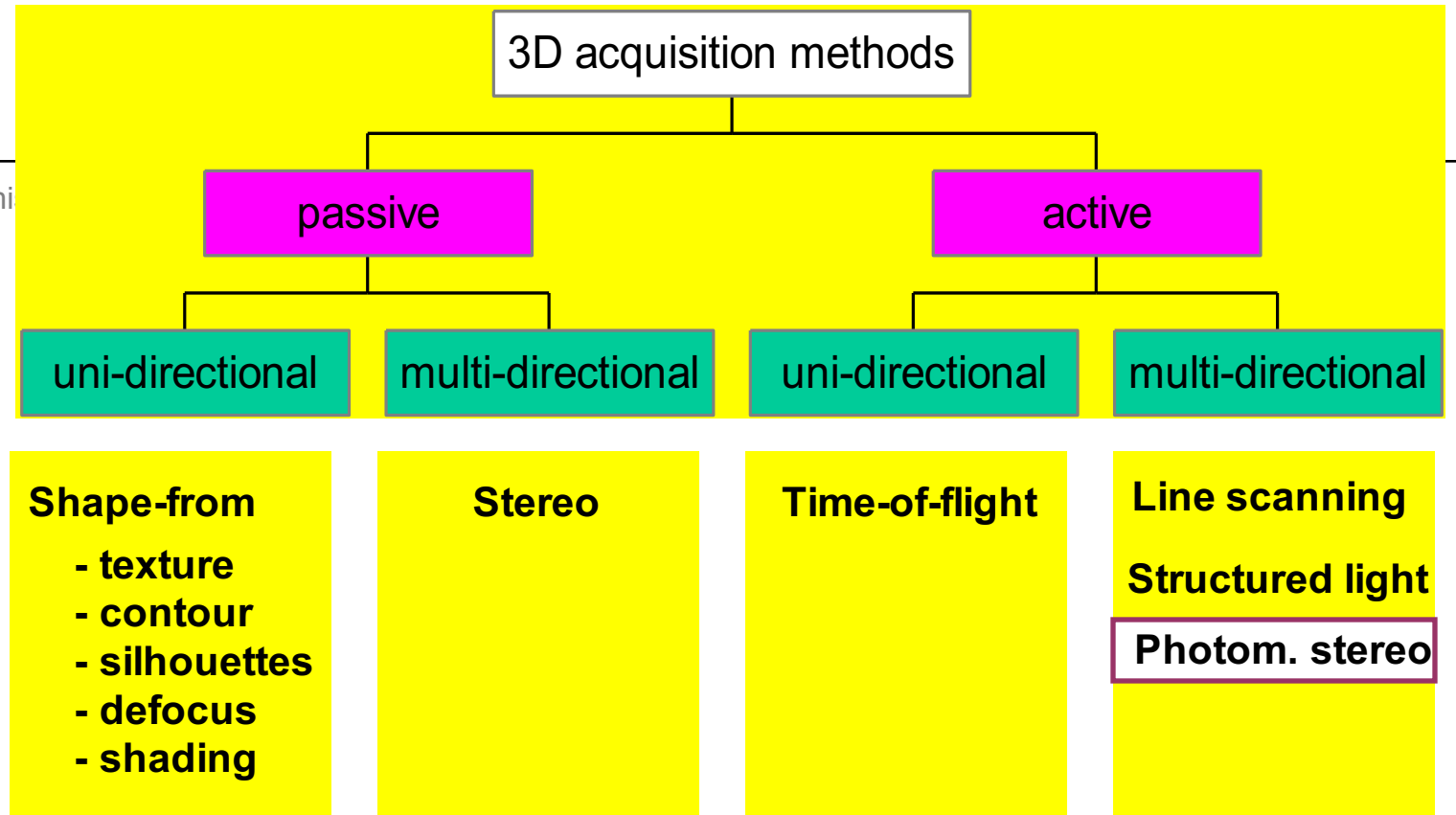

Photometric stereo

constraint propagation eliminated by using light from different directions

simultaneously when the light sources are given different colours



Mini-dome for photometric stereo

Instead of working with multi-directional light applied simultaneously with the colour trick, one can also project from many directions in sequence...

Mini-dome for photometric stereo

KATHOLIEKE UNIVERSITEIT
LEUVEN

Mini-dome



Mini-dome



Mini-dome for photometric stereo

Example for tablet with first world map known,
an exhibit at the British Museum:

<http://homes.esat.kuleuven.be/~mproesma/mptmp/cuneiform>

Mini-dome for photometric stereo

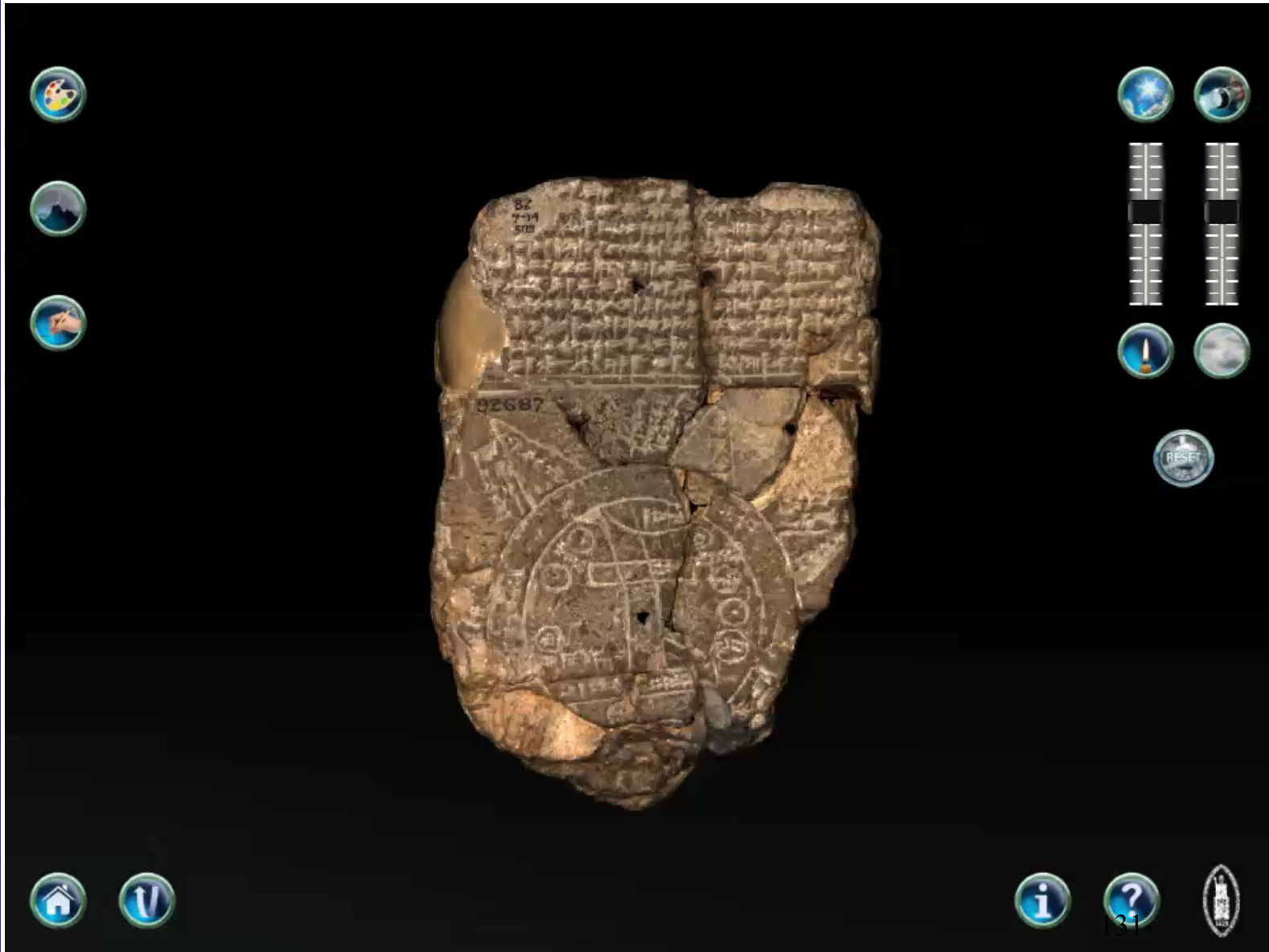

3D and recognition integrated

3D City Modeling using Cognitive Loops



Multi-walker tracker



Strongest 3D cues for us are 2D...

