



BASEMENT

**BASIC SIMULATION ENVIRONMENT
FOR MODELLING OF ENVIRONMENTAL
FLOWS AND NATURAL HAZARDS**

SYSTEM MANUALS

**VERSION 4.0
FEBRUARY 2023**

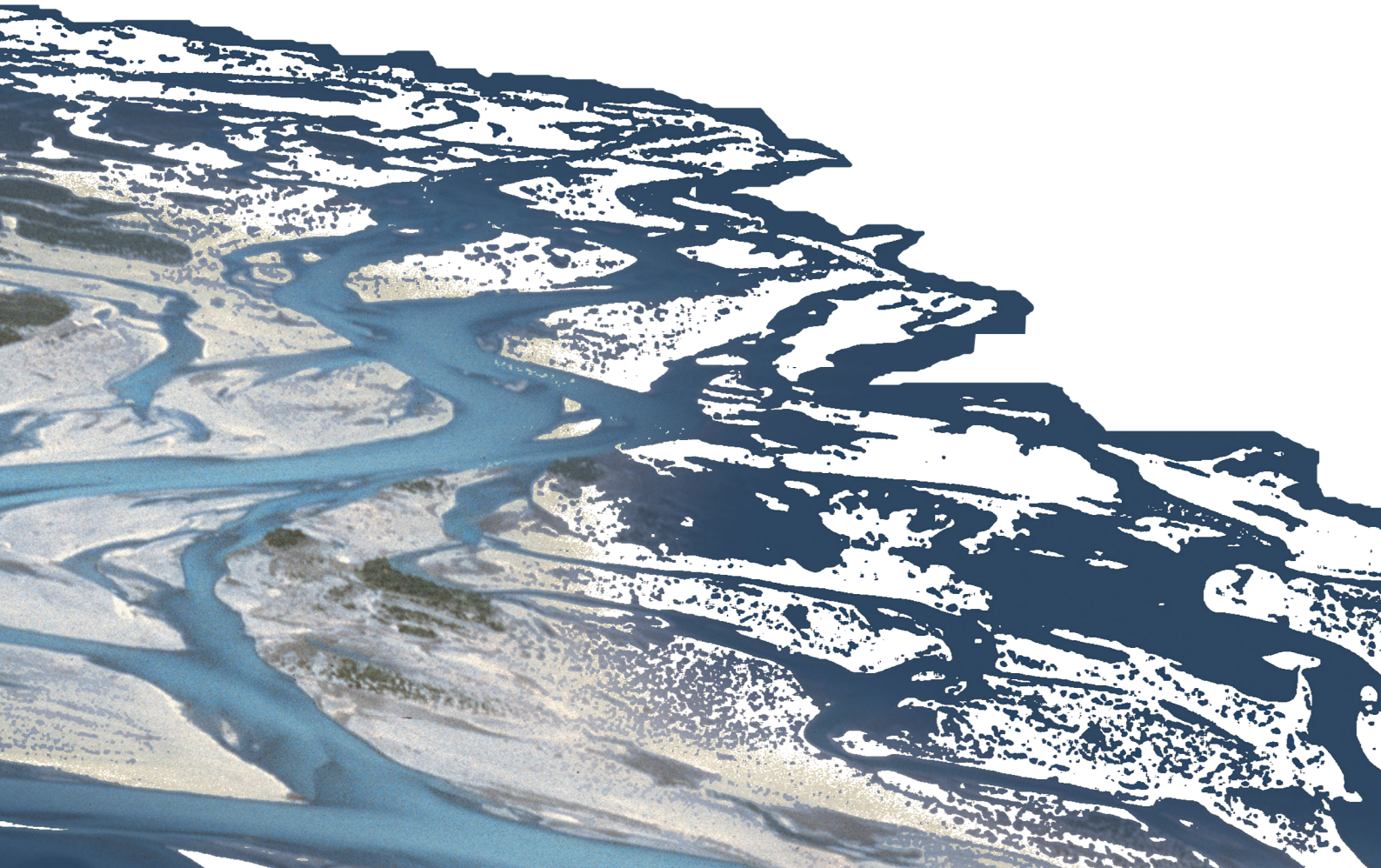

Preamble

VERSION 4.0.0

February 2023

Credits

Contributors

Over the years, many enthusiastic engineers and developers have contributed to the development, testing and documentation of BASEMENT. An up-to-date overview of the current development team, along with current and former contributors, can be found on our website:

<https://basement.ethz.ch/people>

Commissioned and co-financed by

Swiss Federal Office for the Environment (FOEN)

Contact

Website: <https://www.basement.ethz.ch>

User forum: <https://people.ee.ethz.ch/~basement/forum>

ETH Zurich / Laboratory of Hydraulics, Glaciology and Hydrology (VAW)

For list of contributors see <https://www.basement.ethz.ch>



Laboratory of Hydraulics,
Hydrology and Glaciology



Eidgenössische Technische Hochschule Zürich
Swiss Federal Institute of Technology Zurich

Citation Advice

For System Manuals:

Vetsch D., Siviglia A., Bacigaluppi P., Bürgler M., Caponi F., Conde D., Gerke E., Halso M., Kammerer S., Koch A., Peter S., Vanzo D., Vonwiller L., Weberndorfer M. 2023. System Manuals of BASEMENT, Version 4.0.0. Laboratory of Hydraulics, Glaciology and Hydrology (VAW). ETH Zurich. Available from <https://www.basement.ethz.ch>. [date of access].

For Website:

BASEMENT – Basic Simulation Environment for Computation of Environmental Flow and Natural Hazard Simulation, 2023. <https://www.basement.ethz.ch>

For Software:

BASEMENT – Basic Simulation Environment for Computation of Environmental Flows and Natural Hazard Simulation. Version 4.0.0 ETH Zurich, VAW, 2023.

License

End-User License Agreement (EULA)

THIS EULA IS INTENDED FOR COMMERCIAL AND NON-COMMERCIAL PURPOSES. FOR QUESTIONS RELATED TO THIS AGREEMENT PLEASE CONTACT: Dr. David Vetsch, basement@ethz.ch

This End-User License Agreement (“EULA”) is a legal agreement between you (“You”) (an individual or acting on behalf of a company) and ETH Zurich, Raemistrasse 101, 8092 Zurich (Switzerland) (“ETH Zurich”) for the binary software code of **BASEMENT** and associated media, and may include “online” or electronic documentation (“SOFTWARE”).

The SOFTWARE simulates water flow, sediment and scalar transport in rivers and according interaction in consideration of movable boundaries and morphological changes. Further information and description of the SOFTWARE is available here: <https://basement.ethz.ch/>

The SOFTWARE is protected by copyright laws. The SOFTWARE is hereby licensed, not sold.

In order to install and use the SOFTWARE, You must indicate agreement with the following terms and conditions by clicking “ACCEPT” at the end of this EULA during the installation process.

1 LICENSE GRANT

- (i) ETH Zurich hereby grants to You, and in case You are acting on behalf of a company also to the employees of such company, a free-of-charge, single, non-exclusive, world-wide, non-transferable, non-sublicensable right to install, execute and display the SOFTWARE on device(s) running a validly licensed copy of the operating system for which the SOFTWARE was designed. Such rights are granted for commercial and non-commercial purposes.
- (ii) With respect to electronic documents included with the SOFTWARE, You may make an unlimited number of copies (either in hardcopy or electronic form), provided that such copies shall be used only for internal purposes and are not republished or distributed to any third party.

2 USE OF RESULTS GENERATED BY THE SOFTWARE

You are allowed to use the content generated by the SOFTWARE (“SOFTWARE RESULTS”) for commercial and non-commercial purposes.

Note that any attribution (e.g. ETH Zurich logo) on the SOFTWARE RESULTS must be retained. You are not allowed to alter, cancel or fade, after a few seconds, such attribution.

3 THIRD PARTY CODE

The SOFTWARE may contain other program code from third parties. A list of other third party code and libraries used by this SOFTWARE is available here: <https://basement.ethz.ch/about/thirdpartysoftware>

Their license applies to such third party code and libraries contained herein. Refer to the above internet site for the licenses and copyrights.

4 DURATION OF LICENSE AND TERMINATION

This EULA enters into effect on the date of acceptance of this EULA by You. This EULA,

- (i) may be terminated by ETH Zurich at any time for any reason;
- (ii) will terminate automatically without notice from ETH Zurich if (a) You fail to comply with any term(s) of this EULA or (b) You refuse, after the notification in accordance with clause 10 (i), to accept the new EULA term and conditions provided by ETH Zurich;
- (iii) is terminated as soon as You cease to use the SOFTWARE and destroy all copies, full or partial, of the SOFTWARE;

Upon termination pursuant to (i) and (ii), you must cease all use of the SOFTWARE and destroy all copies, full or partial, of the SOFTWARE.

5 OBLIGATIONS OF YOU

- (i) You may not remove or alter any copyright notices on any and all copies of the SOFTWARE.
- (ii) You may not distribute or assign the SOFTWARE or any copy thereof to third parties. You may not rent, lease, sell, lend, transfer, redistribute, or sublicense the SOFTWARE to any third party.
- (iii) You may not reverse engineer, decompile or disassemble the SOFTWARE, except and only to the extent that such activity is expressly permitted by applicable law despite this limitation.
- (iv) You may not reproduce, modify or adapt the SOFTWARE, except and only to the extent that such activity is expressly permitted by applicable law despite this limitation.
- (v) You must comply with all applicable laws.

6 OWNERSHIP

Except as expressly licensed to You in this EULA, ETH Zurich and its licensors retains all right, title, and interest in and to the SOFTWARE. All title and copyrights in and to the SOFTWARE (including but not limited to any images, photographs, animations, video, audio, music, text, and “applets” incorporated into the SOFTWARE), the accompanying materials, and any copies of the SOFTWARE are owned by ETH Zurich and its licensors. The SOFTWARE is protected by copyright laws. Therefore, You must treat the SOFTWARE like any other copyrighted material. All rights not expressly granted are reserved by ETH Zurich.

7 MAINTENANCE, SUPPORT, UPGRADES OR NEW RELEASES

ETH Zurich has no obligation to provide maintenance, support, upgrades, new releases, enhancements or modifications and disclaims all costs associated with service, repair or correction of the SOFTWARE. If any supplemental software code is provided to You by ETH Zurich, this supplemental software code shall be considered part of the SOFTWARE and is subject to the terms and conditions of this EULA if not otherwise explicitly written. It is expressly acknowledged by You that no rights to receive maintenance, support, upgrades, new releases, enhancements or modifications may be derived from this EULA.

8 NO WARRANTY

YOU EXPRESSLY ACKNOWLEDGE AND AGREE THAT USE OF THE SOFTWARE IS AT YOUR SOLE RISK AND THAT THE ENTIRE RISK AS TO SATISFACTORY QUALITY, PERFORMANCE, ACCURACY, AND EFFORT IS WITH YOU. TO THE MAXIMUM EXTENT PERMITTED BY APPLICABLE LAW, THE SOFTWARE AND ANY SERVICES PERFORMED OR PROVIDED BY THE SOFTWARE ARE PROVIDED “AS IS” AND “AS AVAILABLE”, WITH ALL FAULTS AND WITHOUT WARRANTY OF ANY KIND, AND ETH ZURICH HEREBY DISCLAIMS ALL WARRANTIES AND CONDITIONS WITH RESPECT TO THE SOFTWARE AND ANY SERVICES, EITHER EXPRESS, IMPLIED, OR STATUTORY, INCLUDING, BUT NOT LIMITED TO, THE IMPLIED WARRANTIES AND/OR CONDITIONS OF MERCHANTABILITY, OF SATISFACTORY QUALITY, OF FITNESS FOR A PARTICULAR PURPOSE, OF ACCURACY, OF QUIET ENJOYMENT, AND OF NON-INFRINGEMENT OF THIRD-PARTY RIGHTS. ETH ZURICH DOES NOT WARRANT AGAINST INTERFERENCE WITH YOUR ENJOYMENT OF THE SOFTWARE, THAT THE FUNCTIONS CONTAINED IN OR SERVICES PERFORMED OR PROVIDED BY THE SOFTWARE WILL MEET YOUR REQUIREMENTS, THAT THE OPERATION OF THE SOFTWARE OR SERVICES WILL BE UNINTERRUPTED OR ERROR-FREE, OR THAT DEFECTS IN THE SOFTWARE OR SERVICES WILL BE CORRECTED. NO ORAL OR WRITTEN INFORMATION OR ADVICE GIVEN BY ETH ZURICH OR ITS AUTHORIZED REPRESENTATIVE SHALL CREATE A WARRANTY. SHOULD THE SOFTWARE OR SERVICES PROVE DEFECTIVE, YOU ASSUME THE ENTIRE COST OF ALL NECESSARY SERVICING, REPAIR, OR CORRECTION. SOME JURISDICTIONS DO NOT ALLOW THE EXCLUSION OF IMPLIED WARRANTIES OR LIMITATIONS ON APPLICABLE STATUTORY RIGHTS OF A CONSUMER, SO THE ABOVE EXCLUSION AND LIMITATIONS MAY NOT APPLY TO YOU.

9 LIABILITY

In no event shall ETH Zurich be liable for any damages (including, without limitation, lost profits, business interruption, or lost information) arising from the use of or inability

to use the SOFTWARE through You or the employees of the company You are legally representing. In no event will ETH Zurich be liable for loss of data or for indirect, special, incidental, consequential (including loss of profit), or other damages based in contract, tort or otherwise.

The above limitation of liability shall not be construed to amend or limit any party's statutory liability.

10 GENERAL PROVISIONS

- (i) ETH Zurich reserves the right to change the terms and conditions of this EULA at any point in time. In such event, ETH Zurich will notify You in due time of the changes to the terms of the EULA.
- (ii) Rights and duties derived from this EULA shall not be transferred to third parties without the written acceptance of the ETH Zurich.
- (iii) You shall not infer from this EULA any other rights, including licenses, than those that are explicitly stated herein.
- (iv) This EULA shall exclusively be governed by and interpreted in accordance with the laws of Switzerland, without reference to its conflict of laws principles. The exclusive place of jurisdiction is Zurich (Switzerland).

11 ACKNOWLEDGMENT

You acknowledge that you have read this EULA, understand it, and had an opportunity to seek independent legal advice prior to agreeing to it. In consideration of ETH Zurich agreeing to provide the SOFTWARE, You agree to be bound by the terms and conditions of this EULA. You further agree that it is the complete and exclusive statement of the agreement between you and ETH Zurich, which supersedes any proposal or prior agreement, oral or written, and any other communication between you and ETH Zurich relating to the subject of this EULA.

Notice:

Third party software copyright notices and third party software licenses can be found in the appendix.

**BASIC SIMULATION ENVIRONMENT
FOR MODELLING OF ENVIRONMENTAL
FLOWS AND NATURAL HAZARDS**

TEST CASES

**VERSION 4.0
FEBRUARY 2023**



BASEMENT

Contents

1	Hydrodynamics	5
1.1	Introduction	5
1.2	Common Test Cases	5
1.2.1	H_1: Dam break in a closed channel	5
1.2.1.1	Intention	5
1.2.1.2	Description	5
1.2.1.3	Geometry and Initial Conditions	6
1.2.1.4	Boundary Conditions	6
1.2.2	H_2: One dimensional dam break on planar bed	6
1.2.2.1	Intention	6
1.2.2.2	Description	7
1.2.2.3	Geometry and Initial Conditions	7
1.2.2.4	Boundary Conditions	7
1.2.3	H_3: One dimensional dam break on sloped bed	7
1.2.3.1	Intention	7
1.2.3.2	Description	8
1.2.3.3	Geometry and Initial Conditions	8
1.2.3.4	Boundary Conditions	8
1.2.4	H_4 : Parallel execution	8
1.2.4.1	Intention	8
1.2.4.2	Description	8
1.2.4.3	Geometry, initial conditions and boundary conditions	9
1.2.5	H_5: Controlled Boundary Condition	9
1.2.5.1	Intention	9
1.2.5.2	Description	9
1.3	BASEchain Specific Test Cases	10
1.3.1	H_BC_1: Fluid at rest in a closed channel with strongly varying geometry	10
1.3.1.1	Intention	10
1.3.1.2	Description	10
1.3.1.3	Geometry and Initial Conditions	10
1.3.1.4	Boundary Conditions	10
1.3.2	H_BC_2: bed load simulation with implicit hydraulic solution	10
1.3.2.1	Intention	10
1.3.2.2	Description	11
1.3.2.3	Geometry and general data	11
1.4	BASEplane Specific Test Cases	11
1.4.1	H_BP_1: Rest Water in a closed area with strongly varying bottom	11
1.4.1.1	Intention	11

1.4.1.2	Description	11
1.4.1.3	Geometry and Initial Conditions	12
1.4.1.4	Boundary Conditions	12
1.4.2	H_BP_2: Rest Water in a closed area with partially wet elements .	13
1.4.2.1	Intention	13
1.4.2.2	Description	13
1.4.2.3	Geometry and Initial Conditions	13
1.4.2.4	Boundary Conditions	13
1.4.3	H_BP_3: Dam break within strongly bended geometry	14
1.4.3.1	Intention	14
1.4.3.2	Description	14
1.4.3.3	Geometry and Initial Conditions	14
1.4.3.4	Boundary Conditions	14
1.4.4	H_BP_4: Malpasset dam break	15
1.4.4.1	Intention	15
1.4.4.2	Description	15
1.4.4.3	Geometry and Initial Conditions	15
1.4.4.4	Boundary Conditions	16
1.4.5	H_BP_5: Circular dam break wave	16
1.4.5.1	Intention	16
1.4.5.2	Description	16
1.4.5.3	Geometry and Initial Conditions	16
1.4.5.4	Boundary Conditions	17
1.5	Results	17
1.5.1	Common Test Cases	17
1.5.1.1	H_1: Dam break in a closed channel	17
1.5.1.2	H_2: One dimensional dambreak on planar bed	17
1.5.1.3	H_3: One dimensional dam break on sloped bed	19
1.5.1.4	H_4 : Parallel execution	22
1.5.1.5	H_5 : Controlled boundary conditions	23
1.5.2	BASEchain Specific Test Cases	23
1.5.2.1	H_BC_1: Fluid at rest in a closed channel with strongly varying geometry	23
1.5.2.2	H_BC_2: bed load simulation with implicit hydraulic solution	25
1.5.3	BASEplane Specific Test Cases	25
1.5.3.1	H_BP_1: Rest water in a closed area with strongly varying bottom	25
1.5.3.2	H_BP_2: Rest Water in a closed area with partially wet elements	25
1.5.3.3	H_BP_3: Dam break within strongly bended geometry . .	25
1.5.3.4	H_BP_4: Malpasset dam break	28
1.5.3.5	H_BP_5: Circular dam break	28
2	Sediment Transport	35
2.1	Introduction	35
2.2	Common Test Cases	35
2.2.1	ST_1: Soni et al: Aggradation due to overloading	35
2.2.1.1	Intention	35

2.2.1.2	Description	35
2.2.1.3	Geometry and general data	36
2.2.1.4	Equilibrium experiments	36
2.2.1.5	Boundary conditions	36
2.2.1.6	Aggradation experiments	37
2.2.2	ST_2 : Saiedi	37
2.2.2.1	Intention	37
2.2.2.2	Description	37
2.2.2.3	Geometry and general data	37
2.2.2.4	Calibration	37
2.2.2.5	Aggradation	38
2.2.3	BeST_3 : Guenter	38
2.2.3.1	Intention	38
2.2.3.2	Description	38
2.2.3.3	Geometry and general data	38
2.2.3.4	Simulation procedure and boundary/initial conditions . . .	39
2.3	BASEchain Specific Test Cases	39
2.3.1	ST_BC_1: Advection of suspended load	39
2.3.1.1	Intention	39
2.3.1.2	Description	39
2.3.1.3	Geometry and initial conditions	39
2.3.1.4	Boundary conditions	40
2.3.2	ST_BC_2: Advection-Diffusion	41
2.3.2.1	Intention	41
2.3.2.2	Description	41
2.3.2.3	Geometry and initial conditions	41
2.3.2.4	Boundary conditions	41
2.4	BASEplane Specific Test Cases	42
2.4.1	ST_BP_1: Advection of suspended load	42
2.4.1.1	Intention	42
2.4.1.2	Description	42
2.4.1.3	Geometry and initial conditions	42
2.4.1.4	Boundary conditions	43
2.5	Results	44
2.5.1	Common Test Cases	44
2.5.1.1	ST_1: Soni	44
2.5.1.2	ST_2: Saiedi	45
2.5.1.3	ST_3: Guenter	47
2.5.2	BASEchain specific Test Cases	50
2.5.2.1	ST_BC_1: Advection of suspended load	50
2.5.2.2	ST_BC_2: Advection-Diffusion	51
2.5.3	BASEplane specific Test Cases	52
2.5.3.1	ST_BP_1: Advection of suspended load	52
3	Model Coupling	55
3.1	Coupling of Domains of Same Type	55
3.1.1	COUPL_1: Sequential two-way coupling with backwater effects . .	55
3.1.1.1	Intention	55
3.1.1.2	Description	55

3.1.1.3	Geometry and initial conditions	55
3.1.2	COUPL_2: River network modelling	56
3.1.2.1	Intention	56
3.1.2.2	Description	56
3.1.2.3	Geometry and initial conditions	56
3.1.3	COUPL_3: Sequential coupling with sediment transport	57
3.1.3.1	Intention	57
3.1.3.2	Description	57
3.1.3.3	Geometry and initial conditions	57
3.2	Results	58
3.2.1	Coupling Test Cases for Domains of Same Type	58
3.2.1.1	COUPL_1: Sequential two-way coupling with backwater effects	58
3.2.1.2	COUPL_2: River network modelling	59
3.2.1.3	COUPL_3: Sequential coupling with sediment transport	60
4	Subsurface Flow	61
4.1	BASEsub1: Saturated, confined water flow in soil	61
4.2	BASEsub2: Water infiltration into partially-saturated soil	61
4.3	BASEsub3: Unsaturated seepage flow	62
5	High-Performance Computing	65
5.1	Introduction and Backends	65
5.1.1	Introduction	65
5.1.2	Backends	65
5.2	Circular dam break	66
5.2.1	Description	66
5.2.2	Geometry and Initial Conditions	66
5.2.3	Results	67
5.2.4	Performance	70
5.2.4.1	Ubuntu	70
5.2.4.2	Windows	73
5.3	Conical Dune	75
5.3.1	Description	75
5.3.2	Geometry and Initial Conditions	75
5.3.3	Results	76
5.4	Dam-break flow in a L-shaped channel with a mobile-bed	79
5.4.1	Description	79
5.4.2	Geometry and initial conditions	79
5.4.3	Results	79
5.4.4	Performance	81
5.4.4.1	Ubuntu	81
5.4.4.2	Windows	83
6	References	85

Hydrodynamics

1.1 Introduction

The test catalogue is intended for the validation of the program. The catalogue consists of different test cases, their geometric and hydraulic fundamentals and the reference data for the comparison with the computed results. The test cases are built up on each other going from easy to more and more complex problems. The hydraulic solver is validated against analytical and experimental solutions using the test cases in Section 1.2. Common test cases are suitable for both, 1-D and 2-D simulations. Specific test cases are intended for either 1-D or 2-D simulations.

1.2 Common Test Cases

1.2.1 H_1: Dam break in a closed channel

1.2.1.1 Intention

The simplest test case check verifies the conservation property of the fluid phase and whether a stable condition can be reached for all control volumes after a finite time. Additionally, wet and dry problematic is tested.

1.2.1.2 Description

Consider a rectangular flume without sediment. The basin is initially filled in the half length with a certain water depth leaving the other side dry. After starting the simulation, the water flows in the other half of the system until it reaches a quiescent state (velocity = 0, half of initial water surface elevation (WSE) everywhere).

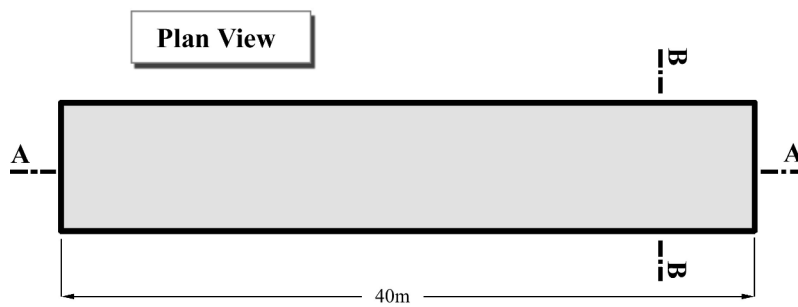

Figure 1.1 H_1: Dam break in a closed channel, plan view

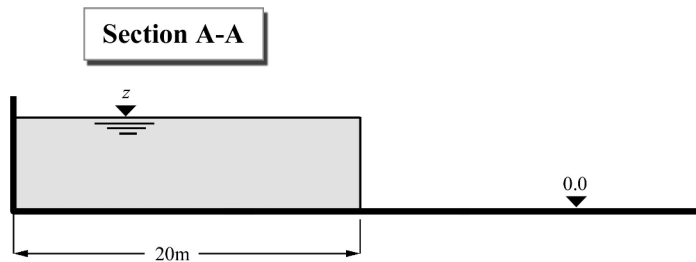

Figure 1.2 H_1: Dam break in a closed channel, section A-A

1.2.1.3 Geometry and Initial Conditions

Initial Condition: water at rest (all velocities zero), the water surface elevation is the same on the half of channel. This test uses a WSE of $z_S = 5.0$ m.

1.2.1.4 Boundary Conditions

No inflow and outflow. All of the boundaries are considered as a wall.

Friction: Manning's factor $n = 0.010$

1.2.2 H_2: One dimensional dam break on planar bed

1.2.2.1 Intention

This test case is similar to the previous one but this one compares the WSE a short time after release of the dam with an analytical solution for this frictionless problem. It is based on the verification of a 1-D transcritical flow model in channels by Tseng (1999).

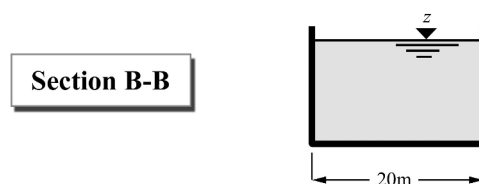

Figure 1.3 H_1: Dam break in a closed channel, section B-B

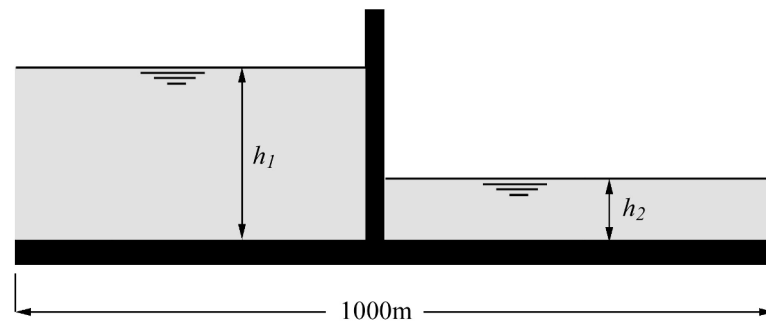

Figure 1.4 *H_2*: One dimensional dam break on planar bed

1.2.2.2 Description

A planar, frictionless rectangular flume has initially a dam in the middle. On one side, the water level is h_2 , on the other side, the water level is at h_1 . At the beginning, the dam is removed and a wave is propagating towards the shallow water. The shape of the wave depends on the fraction of the water depths (h_2/h_1) and can be compared to an analytical, exact solution.

1.2.2.3 Geometry and Initial Conditions

Two cases are considered:

- $h_2/h_1 = 0.001$; $h_1 = 10.0$ m (this avoids problems with wet/dry areas)
- $h_2/h_1 = 0.000$; $h_1 = 10.0$ m (downstream is initially dry)

The dam is exactly in the middle of the channel.

Since it is a one dimensional problem, it should not depend on the width of the model, which can be chosen arbitrary.

1.2.2.4 Boundary Conditions

All cases are frictionless, Manning factor $n=0$.

1.2.3 H_3: One dimensional dam break on sloped bed

1.2.3.1 Intention

Different from the previous cases, this problem uses a sloped bed with friction. The aim is to reproduce an accurate wave front in time. It is based on the verification of a 1-D transcritical flow model in channels by Tseng (1999).

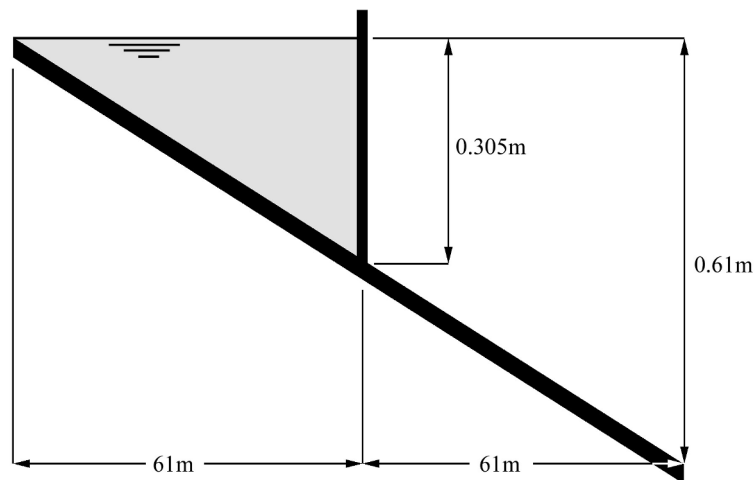

Figure 1.5 H_3: One dimensional dam break on sloped bed

1.2.3.2 Description

In the middle of a slightly sloped flume, an initial dam is removed at time zero (see Figure 1.5). The wave propagates downwards. Comparison data comes from an experimental work. Friction is accounted for with a Manning roughness factor estimated from the experiment.

1.2.3.3 Geometry and Initial Conditions

Length of flume: 122 m
 Width of flume: 1.22 m
 Slope: 0.61 m/122 m
 Initial water level: 0.035 m (at the dam location)

1.2.3.4 Boundary Conditions

Manning friction factor: 0.009
 No inflow/outflow. Boundaries are considered as walls.

1.2.4 H_4 : Parallel execution

1.2.4.1 Intention

To test the parallel performance of hydraulic simulations on a multi-core shared memory computer a test case is set up. The aim is to demonstrate the increase in performance (the speedup) when running BASEMENT in parallel with an increasing number of cores.

1.2.4.2 Description

A hydraulic simulation is repeated with varying number of threads on a multi-core shared memory system. The simulation times are measured and compared to the sequential

execution time in order to evaluate the speedups.

1.2.4.3 Geometry, initial conditions and boundary conditions

A simple rectangular channel with constant slope is considered. The channel is discretized with a large number of cross sections (2000) in BASEchain and a large number of elements (16000) in BASEplane. There is an inflow located at the upper boundary of the channel and an outflow at the lower boundary. The inflowing discharge is constant over the time and steady state conditions within the channel are reached.

Large sized scenarios and evenly distributed work loads (steady state conditions) are set up in order to check for the full potential of the parallel implementation.

1.2.5 H_5: Controlled Boundary Condition

1.2.5.1 Intention

To verify and test the correct action of a PID-controller, steering a boundary condition to keep the water level at a certain cross section or element on the predefined level.

1.2.5.2 Description

The calculation includes a simple channel ending with a weir. In 2-D, two parallel channels are given. One channel is terminated with a weir, the other with a gate. The weir height and gate level is controlled during the simulation by the PID controller and is automatically updated to maintain the predefined water level.

For the 1-D simulation, the discharge in steady state is 100 m³/s. Over 5000 seconds it is increased up to 150 m³/s. The water level is fixed at QP_A18 to 112.6 m. The calculation also includes a feed forward component, directly translating the deviation of the inflow from steady state into an adaption of the weir height.

In 2-D, the discharge is increased from 300 m³/s to 450 m³/s and then lowered to 180 m³/s before it is again set to 300 m³/s. For the 2-D simulation, the target level is not constant, but dependent on the current inflow, which is measured upstream.

Inflow (m ³ /s)	Water level (m)
150	503.0
300	503.2
450	503.4

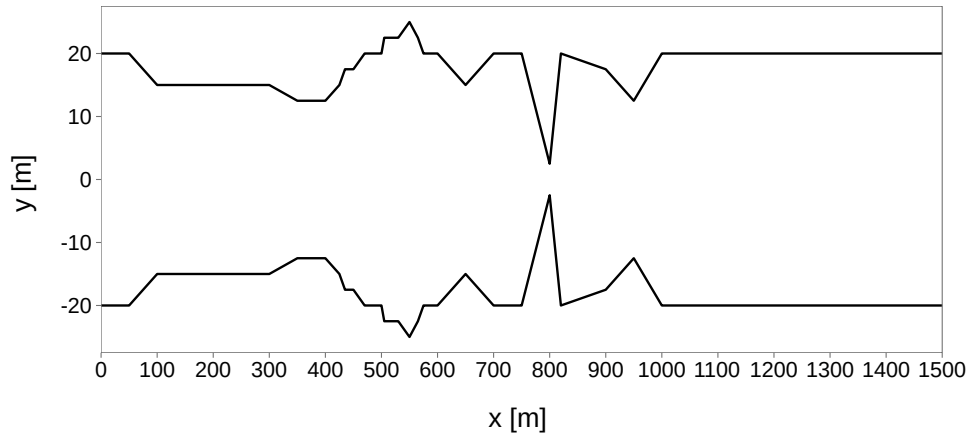

Figure 1.6 H_BC_1: Top view: cross-sections

1.3 BASEchain Specific Test Cases

1.3.1 H_BC_1: Fluid at rest in a closed channel with strongly varying geometry

1.3.1.1 Intention

This test case checks for the conservation of momentum. Numerical artefacts (mostly due to geometrical reasons) could generate impulse waves although there is no acting force.

1.3.1.2 Description

The computational area consists of a rectangular channel with varying bed topology and different cross-sections. The fluid is initially at rest with a constant water surface elevation and there is no acting force. There should be no changes of the WSE in time.

1.3.1.3 Geometry and Initial Conditions

The cross sections and bed topology were chosen as in Figure 1.6 and Figure 1.7. Notice the strong variations within the geometry. The water surface elevation is set to $z_S = 12$ m.

1.3.1.4 Boundary Conditions

All boundaries are considered as walls. There is no friction acting.

1.3.2 H_BC_2: bed load simulation with implicit hydraulic solution

1.3.2.1 Intention

The aim of this test case is to verify if the use of the implicit computation mode leads to the expected gain of computational time for a long sediment transport simulation.

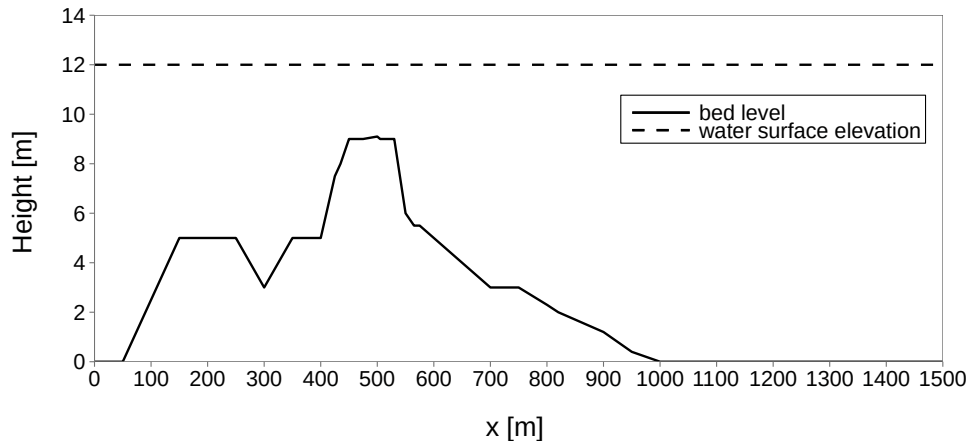

Figure 1.7 H_BC_1: Bed topography and water surface elevation

1.3.2.2 Description

The test case simulates a section of the river Thur near Altikon. At this place, there is a widening of which the morphological evolution should be evaluated.

1.3.2.3 Geometry and general data

The model is composed by 55 irregular cross sections, the mean grain size is 2.5 cm and the length of the transport generating hydrograph is 338 hours. The given time steps for the implicit simulation are 60, 120 and 180 seconds. The Program is allowed to reduce the time step if necessary, but this leads to time loss. The precisions of the results for which the iteration is interrupted are 0.1 m^2 for the wetted area and $0.1 \text{ m}^3/\text{s}$ for the discharge.

1.4 BASEplane Specific Test Cases

1.4.1 H_BP_1: Rest Water in a closed area with strongly varying bottom

1.4.1.1 Intention

This test in two dimensions checks for the conservation of momentum. Numerical artefacts (mostly due to geometrical reasons) could generate impulse waves although there is no acting force.

1.4.1.2 Description

The computational area consists of a rectangular channel with varying bottom topography. The fluid is initially at rest with a constant water surface elevation and there is no acting force. There should be no changes of the WSE in time.

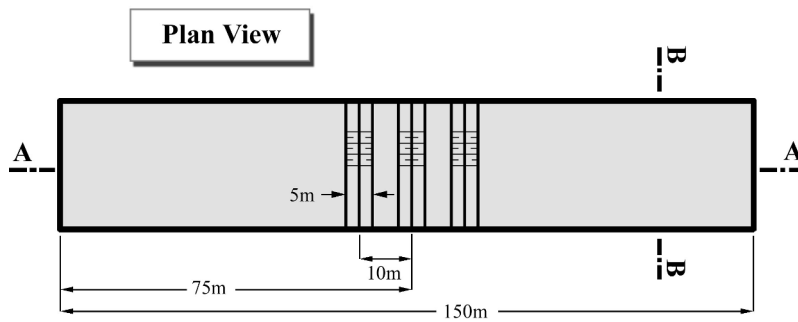

Figure 1.8 H_BP_1: Rest Water in a closed area with strong varying bottom level, plan view

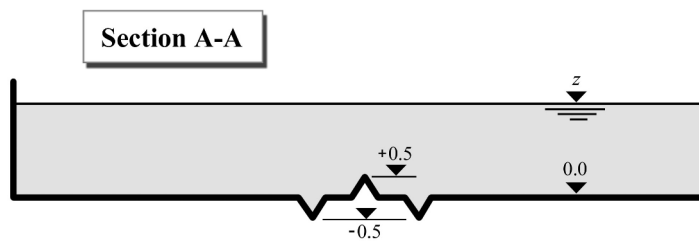

Figure 1.9 H_BP_1: Rest Water in a closed area with strong varying bottom level, section A-A

1.4.1.3 Geometry and Initial Conditions

Initial Condition: totally rest water, the WSE is the same and constant over the domain. The WSE can be varied e.g. from z_S (min) = 0.8 to z_S (max) 3.0 m .

1.4.1.4 Boundary Conditions

No inflow and outflow. All of the boundaries are considered as a wall.

Friction: frictionless test; Manning's factor $n = 0.0$.

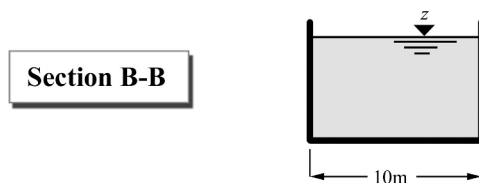

Figure 1.10 H_BP_1: Rest Water in a closed area with strong varying bottom level, section B-B

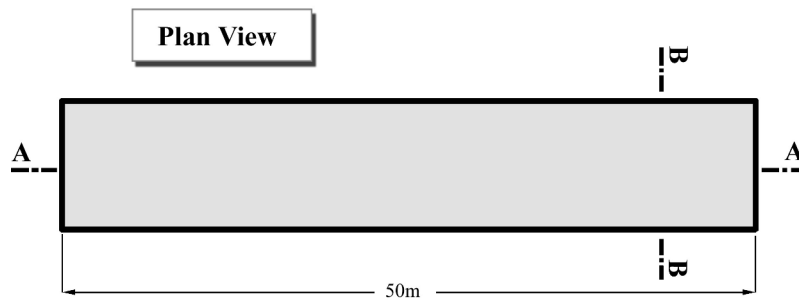

Figure 1.11 H_BP_2: Rest Water in a closed area with partially wet elements, plan view

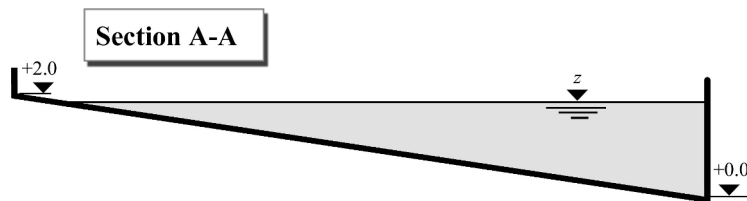

Figure 1.12 H_BP_2: Rest Water in a closed area with partially wet elements, section A-A

1.4.2 H_BP_2: Rest Water in a closed area with partially wet elements

1.4.2.1 Intention

This test case checks the behaviour of partially wet control volumes. The wave front respectively the border wet/dry is always the weak point in a hydraulic computation. There should be no momentum due the partially wet elements.

1.4.2.2 Description

In a sloped, rectangular channel, the WSE is chosen to be small enough to allow for partially wet elements. The water is at rest and no acting force is present.

1.4.2.3 Geometry and Initial Conditions

Initial Condition: totally rest water, the WSE is the same and constant over the whole domain. The WSE is $z_S = 1.9$ m.

1.4.2.4 Boundary Conditions

No inflow and outflow. All of the boundaries are considered as a wall.

Friction: frictionless test; Manning's factor $n = 0.0$.

The mesh (grid) can be considered as following pictures. In this form, the partially wet cells (elements) can be handled.

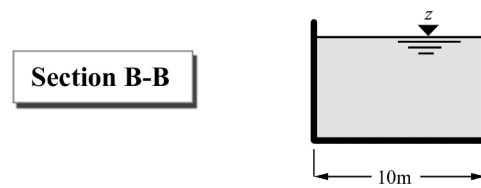

Figure 1.13 H_BP_2: Rest Water in a closed area with partially wet elements, section B-B

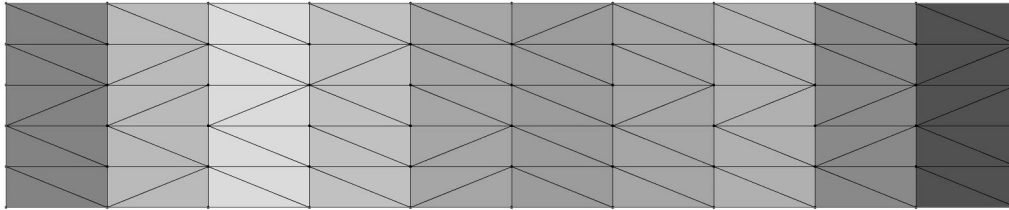

Figure 1.14 H_BP_2: Computational grid

1.4.3 H_BP_3: Dam break within strongly bended geometry

1.4.3.1 Intention

This test case challenges the 2-D code. The geometry permits a strongly two dimensional embossed flow. The results are compared against experimental measurements at certain control points.

1.4.3.2 Description

In a two-dimensional geometry with a jump in bed topology, a gate between reservoir and some outflow channel is removed at the beginning. The bended channel is initially dry and has a free outflow discharge as boundary condition at the downstream end.

1.4.3.3 Geometry and Initial Conditions

The geometry is described in Figure 1.16 and Figure 1.15, G1 to G6 are the measurement control points for the water elevation. Initial condition is a fluid at rest with a water surface elevation of 0.2 m above the channels ground. The channel itself is dry from water. At $z = 0$, the gate between reservoir and gate is removed.

1.4.3.4 Boundary Conditions

No inflow. At the downstream end of the channel, a free outflow condition is employed. All other boundaries are considered as walls.

The friction factor is set to 0.0095 (measured under stationary conditions) for the whole computational domain.

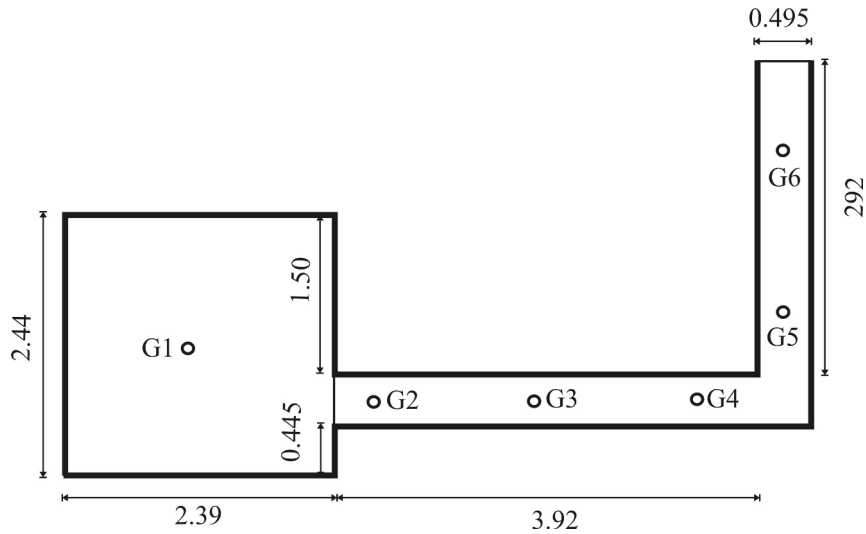

Figure 1.15 *H_BP_3: Strongly bended channel (plane view)*

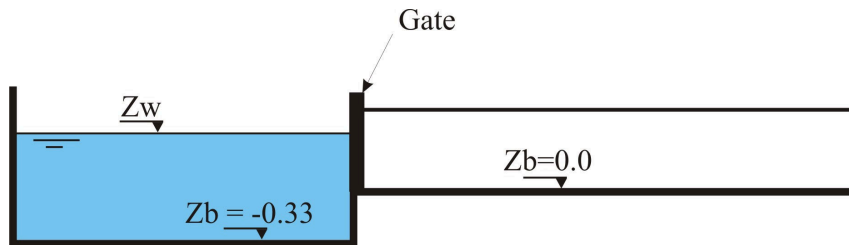

Figure 1.16 *H_BP_3: Strongly bended channel (side view)*

1.4.4 H_BP_4: Malpasset dam break

1.4.4.1 Intention

This final hydraulic test case is the well known real world data set from the Malpasset dam break in France. The complex geometry, high velocities, often and sudden wet-dry changes and the good documentation allow for a fundamental evaluation of the hydraulic code.

1.4.4.2 Description

The Malpasset dam was a doubly-curved equal angle arch type with variable radius. It breached on December 2nd, 1959 all of a sudden. The entire wall collapsed nearly completely what makes this event unique. The breach created a water flood wall 40 meters high and moving at 70 km/h. After 20 minutes, the flood reached the village Frejus and still had 3 m depth. The time of the breach and the flood wave can be exactly reconstructed, as the time is known, when the power of different stations switched off.

1.4.4.3 Geometry and Initial Conditions

Figure 1.18 shows the computational grid used for the simulation. The points represent “measurement” stations. The initial water surface elevation in the storage lake is set to +100.0 m.a.s.l. and in the downstream lake to 0.0 m.a.s.l. The area downstream of the wall is initially dry. At $t=0$, the dam is removed.

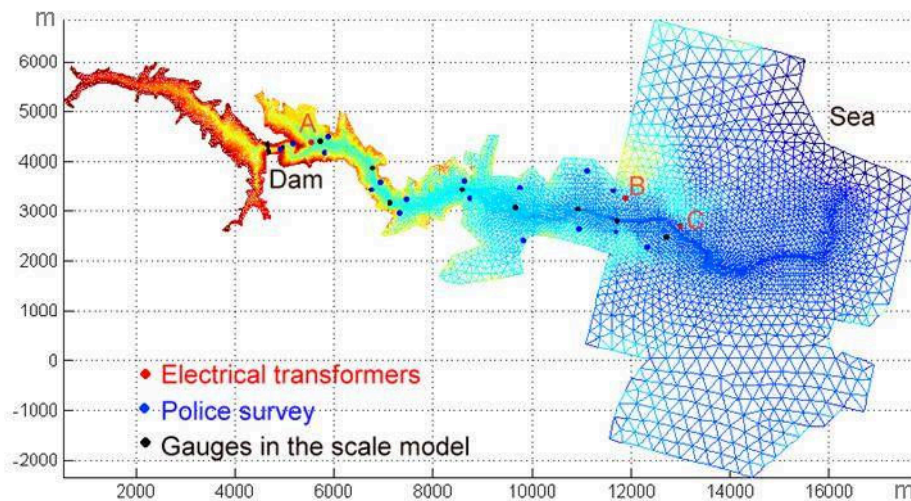

Figure 1.17 *H_BP_4*: Computational area of the malpasset dam break

1.4.4.4 Boundary Conditions

The computational grid was constructed to be large enough for the water to stay within the bounds. Friction is accounted for by a Manning factor of 0.033.

1.4.5 H_BP_5: Circular dam break wave

1.4.5.1 Intention

The circular dam break problem is a demanding two-dimensional test case with some distinct features. It is used to evaluate the capability to correctly model complex interactions of shock and rarefaction waves. The results are qualitatively compared to results obtained by Toro (2001), and other numerical studies, for this idealized dam break scenario. Also the results of the exact and approximate Riemann solvers are compared to each other.

1.4.5.2 Description

A virtual circular dam is located in the center of a computational domain. At the beginning, at time $t = 0.0s$, the dam is removed. The evolution of subsequent wave patterns is examined until about $t = 5s$ after the dam break.

1.4.5.3 Geometry and Initial Conditions

The computational domain has a width and height of 40m and is modelled with a uniform rectangular grid, which consists of 160'000 quadratic elements of the size 0.1m x 0.1m. The grid is selected large enough to fully capture the outward propagating primary shock wave during the simulation time of about 5s. The small element sizes shall enable the modelling of the circular flow patterns with sufficient accuracy.

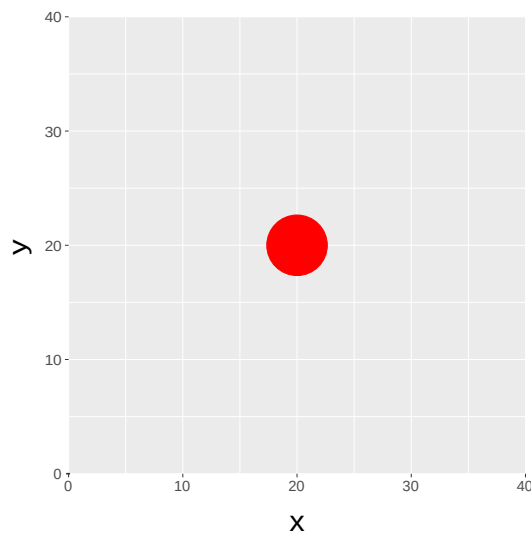

Figure 1.18 *H_BP_5: Computational area (rectangular grid) of circular dam break*

The initial height of the water column is 2.5m, whereas the surrounding initial water surface level is set to 0.5m. The water column behind the circular dam has a radius of 2.5m. The time step is chosen according to a CFL number of 0.9.

1.4.5.4 Boundary Conditions

Friction: frictionless test; Manning's factor $n = 0.0$.

1.5 Results

1.5.1 Common Test Cases

1.5.1.1 H_1: Dam break in a closed channel

The conservation of mass is validated. After $t = 1107$ s, the discharges still have a magnitude of 10^{-6} m³/s with decreasing tendency. Both, BASEchain and BASEplane deliver similar results.

1.5.1.2 H_2: One dimensional dambreak on planar bed

1.5.1.2.1 Results obtained by BASEchain

A comparison of the 1-D test case using $h_2/h_1 = 0.000$ with the analytical solution shows an accurate behaviour of the fluid phase in time.

1.5.1.2.2 Results obtained by BASEplane

In two dimension, the dam break test case was computed using $h_2/h_1 = 0.0$ and $h_1 = 10$ m. The length of the channel was discretized using 1000 control volumes. The CFL number

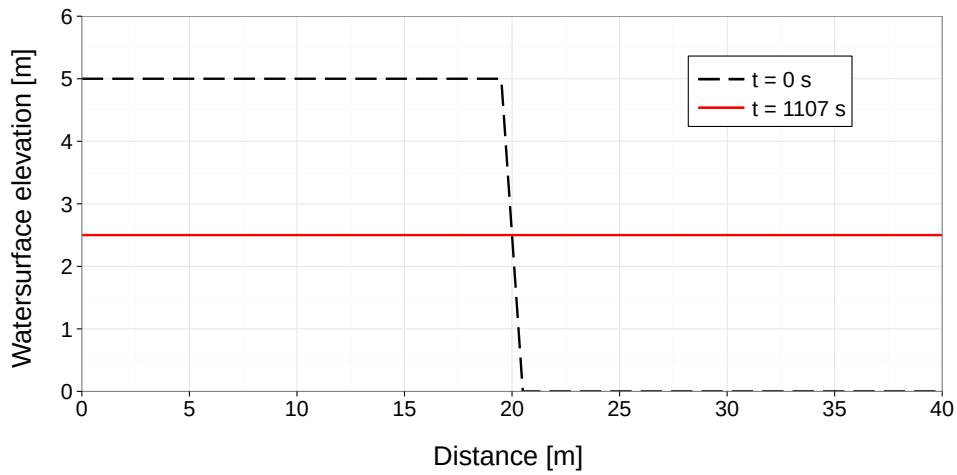

Figure 1.19 H_1: Initial and final water surface elevation (BC & BP)

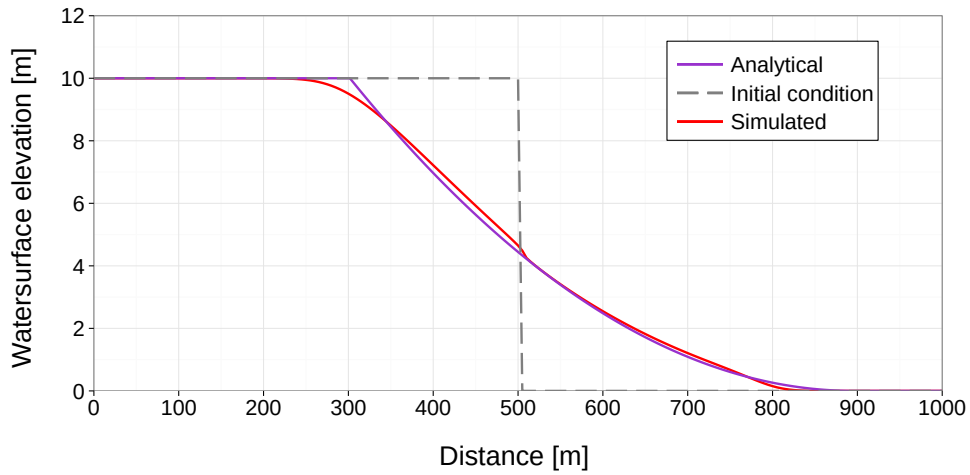

Figure 1.20 H_2: Water surface elevation after 20 s (BC)

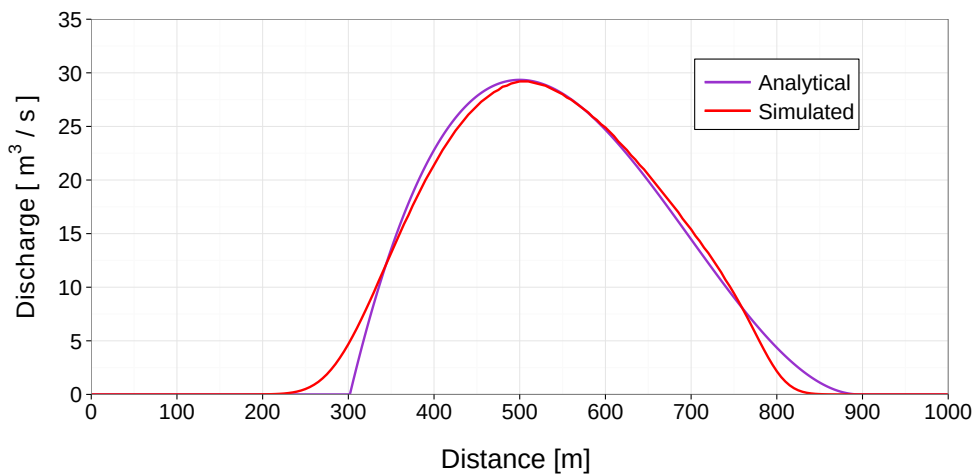

Figure 1.21 H_2: Distribution of discharge after 20 s (BC)

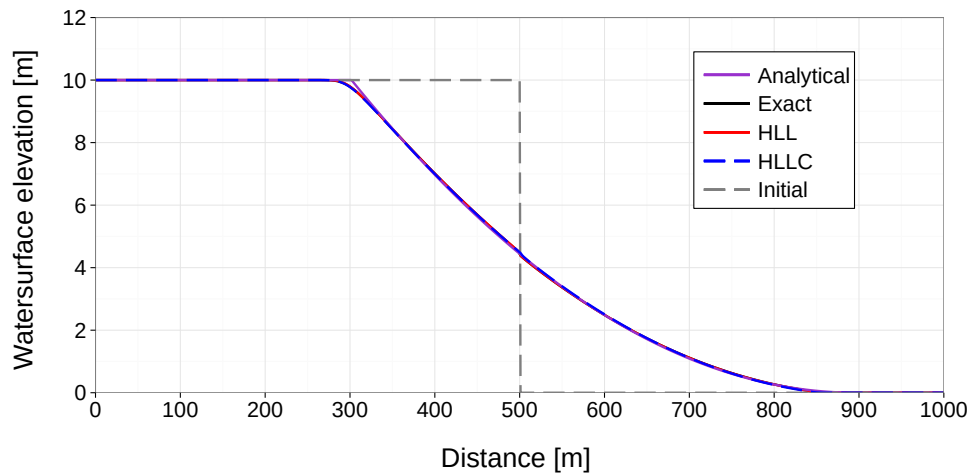

Figure 1.22 *H_2: Flow depth 20 sec after dam break (BP)*

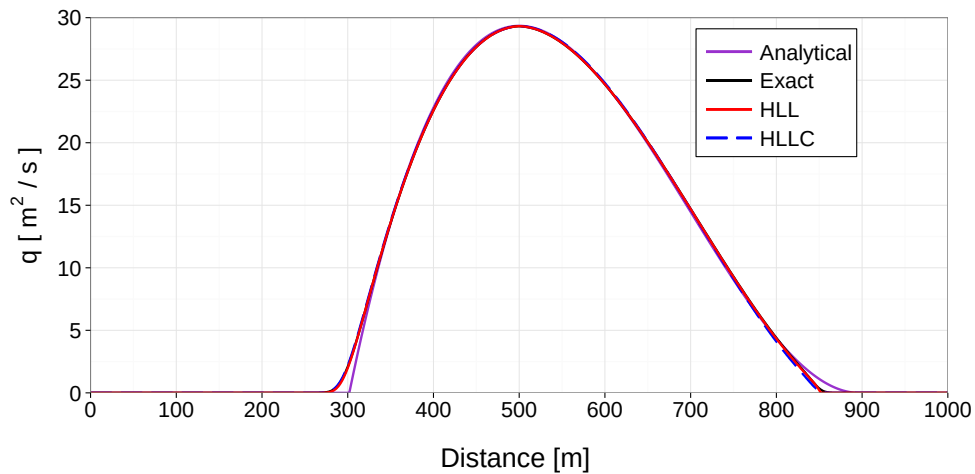

Figure 1.23 *H_2: Discharge 20 sec after dam break (BP)*

was set to 0.85. The results show a good agreement between simulation and analytical solution.

1.5.1.3 H_3: One dimensional dam break on sloped bed

1.5.1.3.1 Results obtained by BASEchain

The dam break in a sloped bed was compared against experimental results. The agreement is satisfying.

1.5.1.3.2 Results obtained by BASEplane

For two dimensions, the numerical results show a good agreement with the experimental measurements. Although in certain areas, the water depth is underestimated, the error is just at 7 % and only for a limited time. The comparison is still successful.

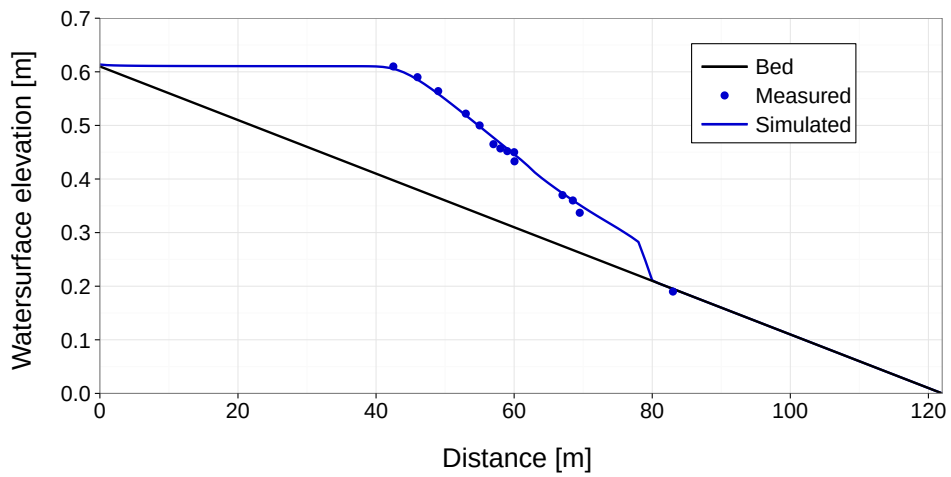

Figure 1.24 H_3: Water surface elevation after 10 s (BC)

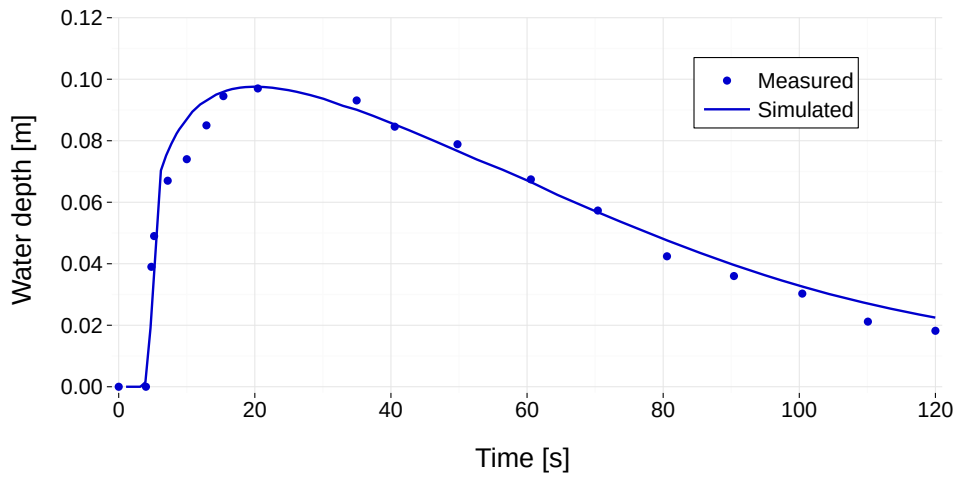

Figure 1.25 H_3: Temporal behaviour of water depth at $x = 70.1$ m (BC)

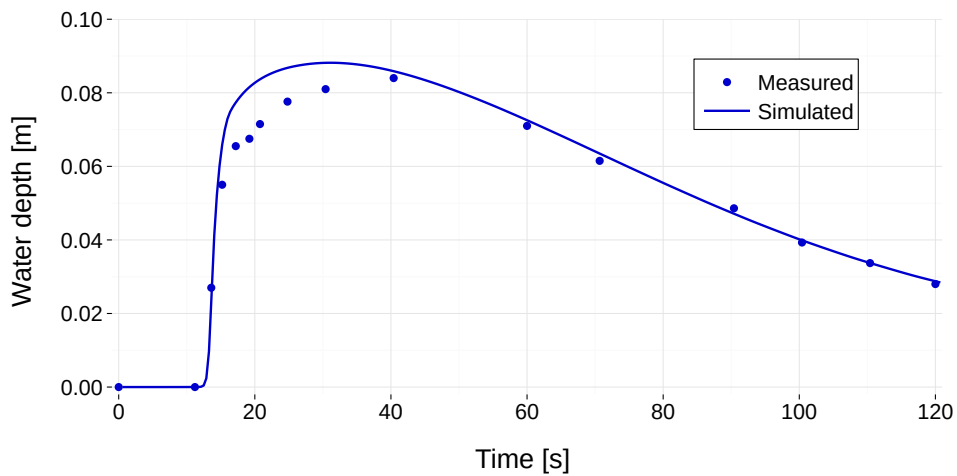

Figure 1.26 H_3: Temporal behavior of water depth at $x = 85.4$ m (BC)

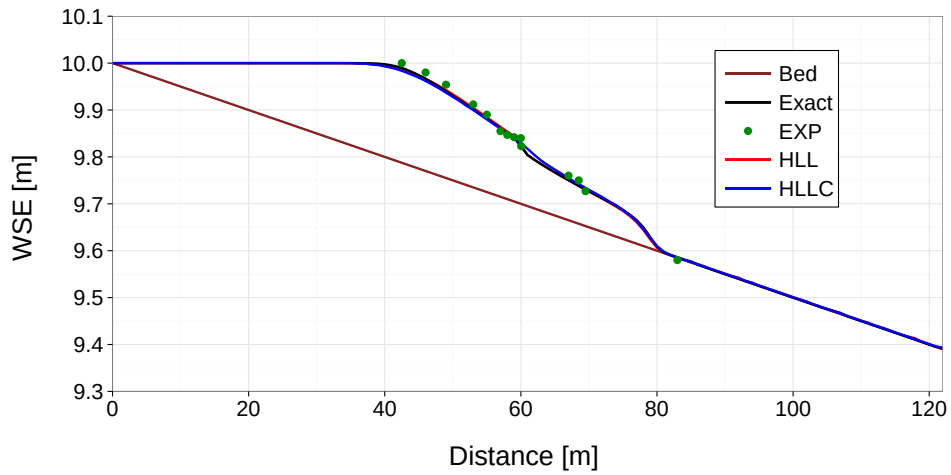

Figure 1.27 H_3: Cross sectional water level after 10 s simulation time (BP)

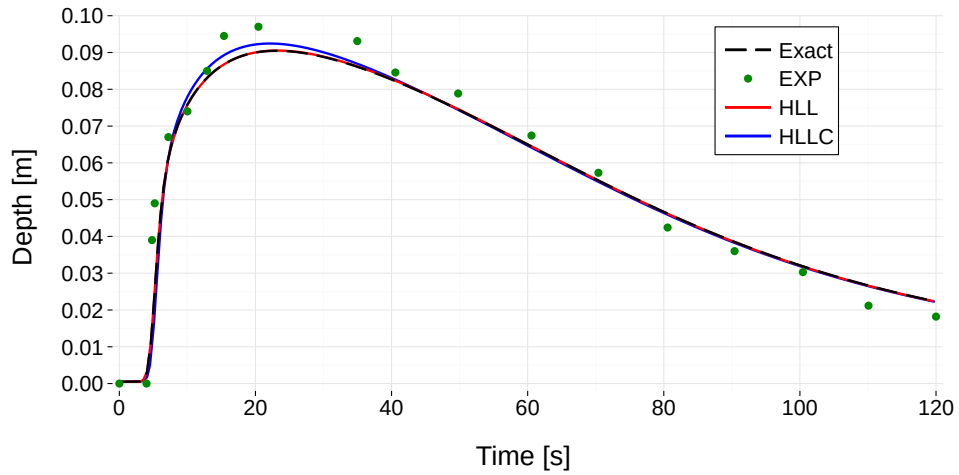

Figure 1.28 H_3: Chronological sequence of water depth at point $x = 70.1$ m (BP)

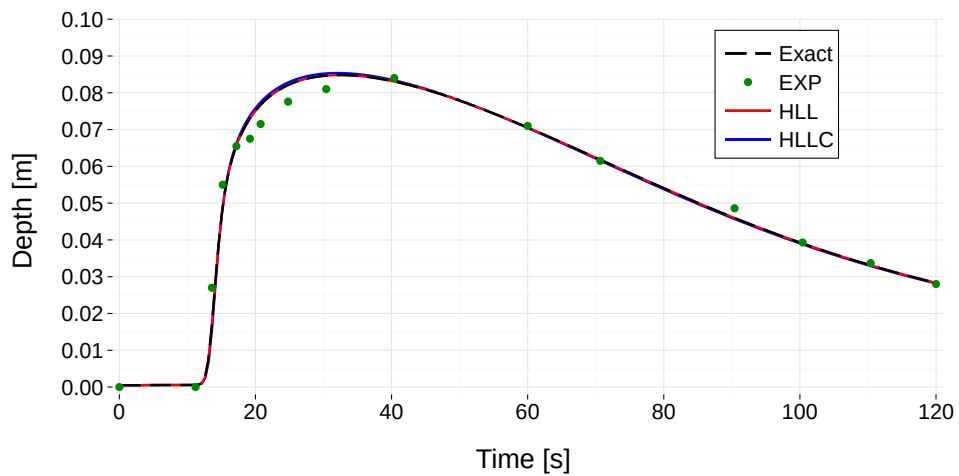

Figure 1.29 H_3: Chronological sequence of water depth at point $x = 85.4$ m (BP)

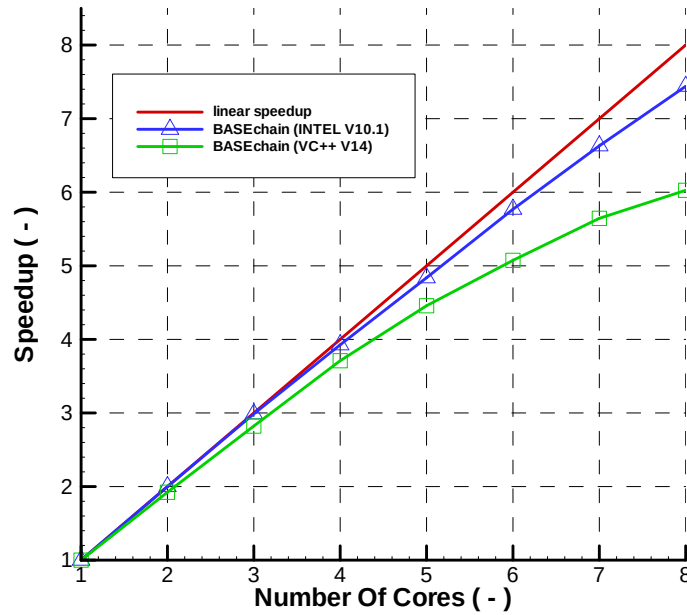

Figure 1.30 H_4 (BASEchain) – Parallel speedup for 1-D test case

1.5.1.4 H_4 : Parallel execution

1.5.1.4.1 General

Hydraulic simulations in a rectangular channel with steady state conditions are repeated multiple times and the execution times are measured. Thereby only the number of used threads is varied from one simulation to another. The selected model scenarios are suited well for parallel execution regarding size and load balancing in order to check the full potential of the parallel execution (in many practical model setups the observed speedups may be significantly lower).

1.5.1.4.2 System configuration

The simulations were performed on an Intel multi-core shared memory system with 8 cores. The used operating system was WinXP 64.

The simulation procedure is repeated with two different versions of BASEMENT. One version (blue) is compiled with the Intel C++ compiler (V 10.1), whereas the other version (green) is compiled with the Microsoft VC++ compiler (V14).

1.5.1.4.3 Results obtained by BASEchain

The results indicate an excellent speedup and scalability. The speedup increases nearly linearly with the number of used cores. The parallel speedups obtained by the Intel compiled binary are superior to those obtained by the VC++ compiled binary.

1.5.1.4.4 Results obtained by BASEplane

The results indicate a satisfactory speedup and scalability. The effect of increasing slope of the blue curve, when running this scenario with 8 cores, is probably due to caching effects. The parallel speedups obtained with the Intel compiled binary are superior to those obtained with the VC++ binary, if the number of cores exceeds 2.

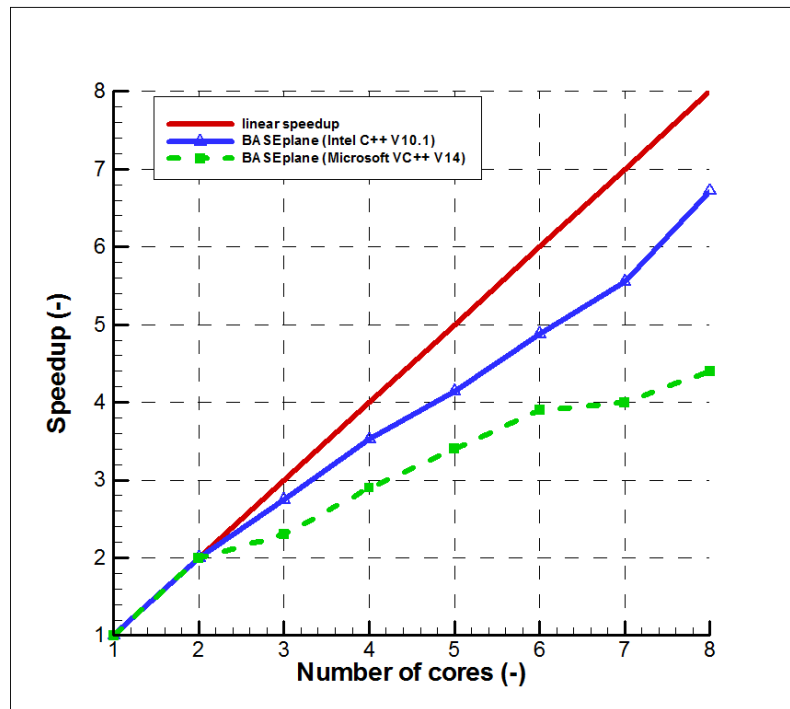

Figure 1.31 H_4 (BASEplane) – Parallel speedup for 2-D test case

1.5.1.5 H_5 : Controlled boundary conditions

1.5.1.5.1 Results for BASEchain

As can be seen in Figure 1.32, the controller is able to maintain the constant water level at 112.6 m precisely.

1.5.1.5.2 Results for BASEplane

Compared to the 1-D simulation, the 2-D test case is a more complicated problem as it involves discharge dependent targets and changes of discharge from $450 \text{ m}^3/\text{s}$ down to $180 \text{ m}^3/\text{s}$ within 5 minutes. This rapid change makes the strict maintaining of the water level difficult. In principle, this could be handled by a stronger reaction of the weir and gate, which would require also a stronger imposed upper limit of the time step to prevent numerical oscillations of the weir and gate height.

1.5.2 BASEchain Specific Test Cases

1.5.2.1 H_{BC_1} : Fluid at rest in a closed channel with strongly varying geometry

The test was successfully carried out. There was no movement at all – the water surface elevation remained constant over the whole area. No picture will be shown as there is nothing interesting to see.

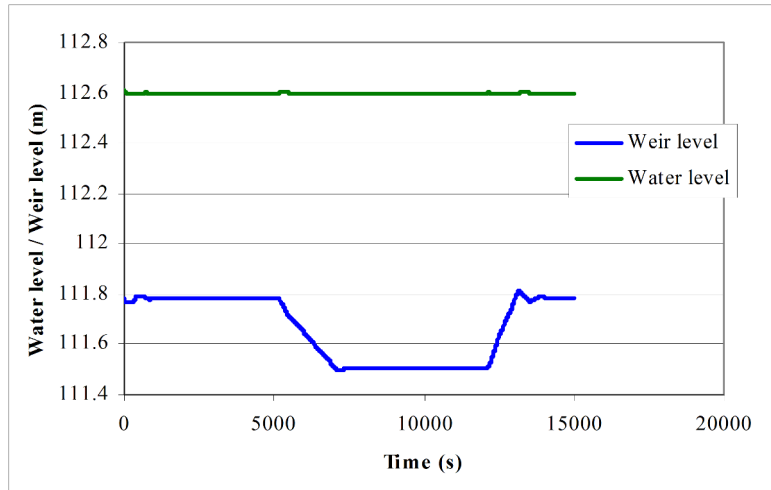

Figure 1.32 H_5 (BASEchain) Controlled weir with changing inflow.

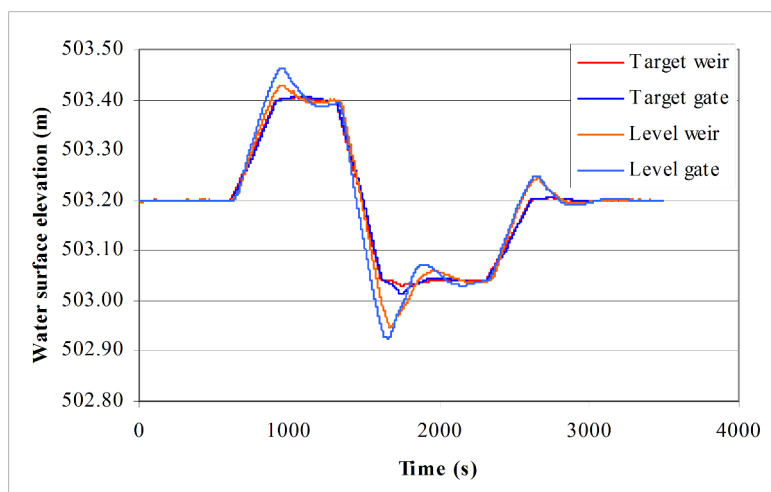

Figure 1.33 H_5 (BASEplane) Controlled weir and gate. The target levels and the actual levels with changing inflow are given.

1.5.2.2 H_BC_2: bed load simulation with implicit hydraulic solution

The time steps and simulation times for the explicit and implicit computations are listed in the table below. The reduction of simulation time is satisfying.

Table 1.2 *H_BC_2 : Performance of implicit calculations*

	Time step (seconds)	Simulation time (hours)	Speedup (times faster)
Explicit	2-5	13.94	
Implicit, base time step = 60	3-90	0.9	15
Implicit, base time step = 120	3-120	0.6	23
Implicit, base time step = 180	3-180	0.47	30

1.5.3 BASEplane Specific Test Cases

1.5.3.1 H_BP_1: Rest water in a closed area with strongly varying bottom

The test was successfully carried out. There was no movement at all – the water surface elevation remained constant over the whole area. No picture will be shown as there is nothing interesting to see.

1.5.3.2 H_BP_2: Rest Water in a closed area with partially wet elements

The test was successfully carried out. There was no movement at all – the water surface elevation remained constant over the whole area. No picture will be shown as there is nothing interesting to see.

1.5.3.3 H_BP_3: Dam break within strongly bended geometry

The computational area was discretized using a mesh with 1805 elements and 1039 vertices. The vertical jump in bed topography between the reservoir and the channel was modelled with a strongly inclined cell (a node can only have one elevation information). Figure 2.1 shows the water level contours and the velocity vectors. The following figures compare the time evolution of the measured water level with the simulated results at the control points G1, G3 and G5.

The results are showing an accurate behaviour expect at the control point G5, where some bigger differences can be observed. They are caused by the use of a coarse mesh around that area. Using a higher mesh density, the water level in the critical area after the strong bend is better resolved and delivers more accurate results. Figure 1.40 shows a comparison at point G5 for a coarse and a dense mesh.

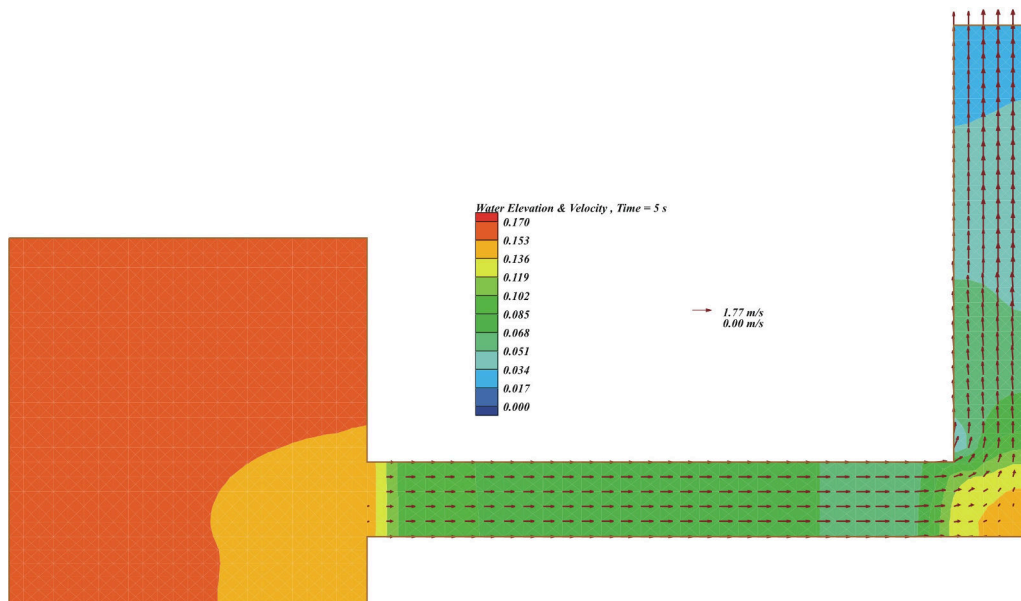

Figure 1.34 H_BP_3: Water level and velocity vectors 5 seconds after the dam break

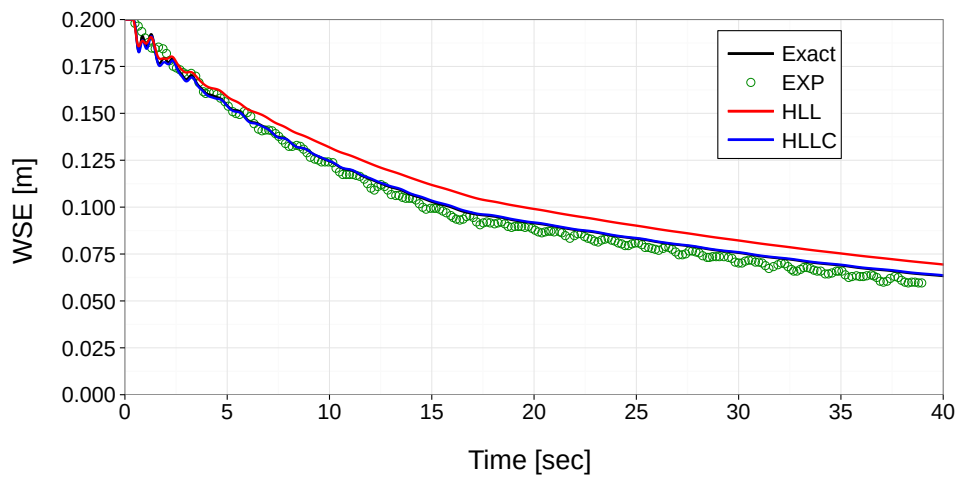

Figure 1.35 H_BP_3: Water surface elevation at G1

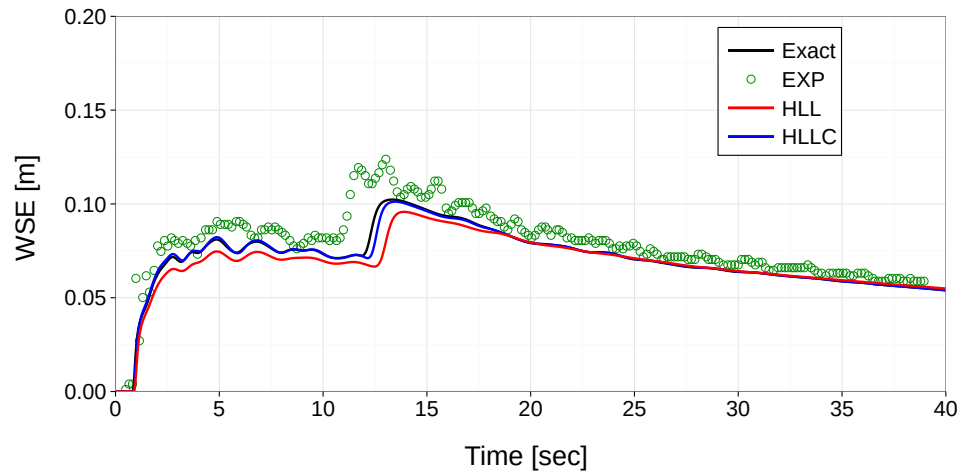

Figure 1.36 H_BP_3 : Water surface elevation at $G3$

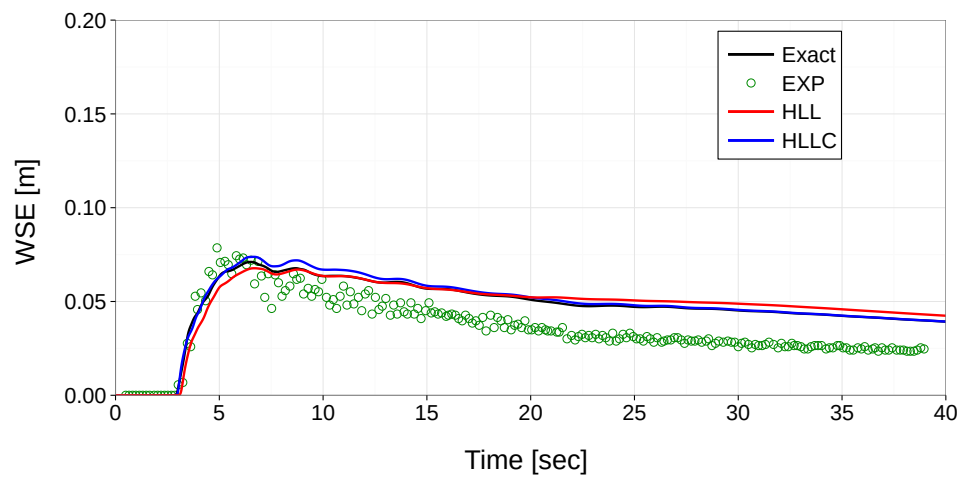

Figure 1.37 H_BP_3 : Water surface elevation at $G5$

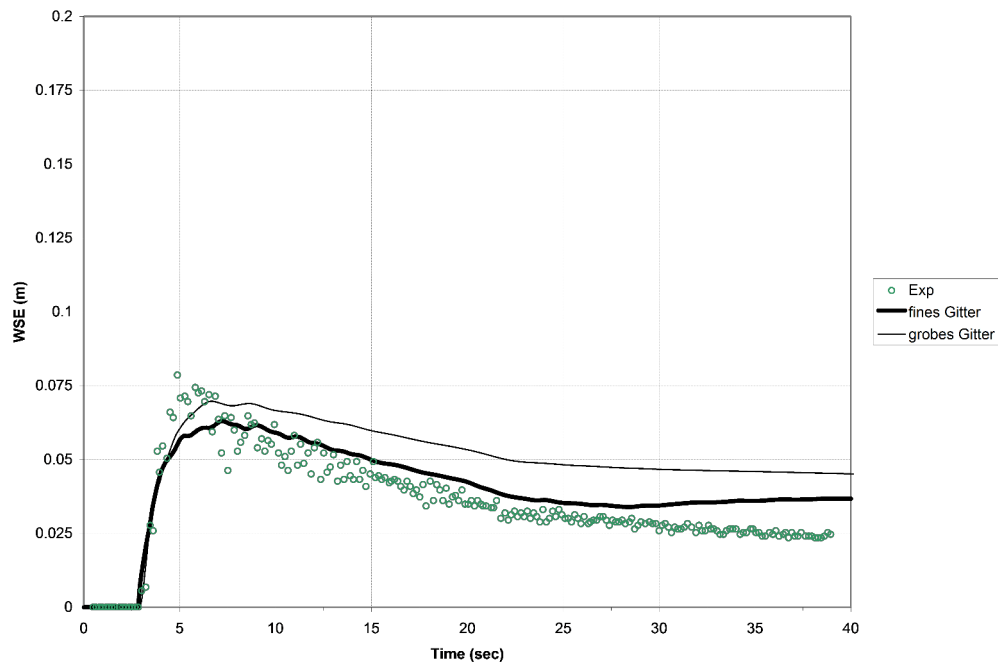

Figure 1.38 H_BP_5 : Comparison of the water level at point $G5$ for a coarse and a dense grid.

1.5.3.4 H_BP_4 : Malpasset dam break

The computational grid consists of 26'000 triangulated control volumes and 13'541 vertices. The time step was chosen according to a CFL number of 0.85. Figure 1.39 shows the computed water depth and velocities 300 seconds after the dam break. Figure 1.40 compares several computed with the observed data on water level elevation at different stations.

BASEplane results show a good agreement with the observed values as also other simulation results (Valiani et al. (2002) and Yoon and Kang (2004)). The differences between computed and measured data are maximally around 10%.

1.5.3.5 H_BP_5 : Circular dam break

The obtained results for the circular dam break test case are plotted in two different ways. A 3-D perspective view of the depth is shown from Figure 1.41 to Figure 1.46 to illustrate the overall flow and wave patterns. Additional water surface and velocity profiles are plotted from Figure 1.47 to Figure 1.48 for distinct times.

The following flow patterns of the 2-D circular dam break are reported by Toro and other numerical studies and are also observed here.

After the collapse of dam at $t = 0.0$ s an outward propagating, primary shock wave is created. A sharp depth gradient develops behind this shock wave. Also, a rarefaction wave is generated which propagates inwards in the direction of the center of the dam break. The rarefaction wave finally reaches the center and generates a very distinct dip of the surface elevation at the center ($t = 0.4$ s) This dip travels outwards resulting in a rapid drop of the surface elevation at the center, which falls even below the initial outer water level ($t = 1.4$ s) and finally nearly reaches the ground ($t = 3.5$ s). A second shock wave develops

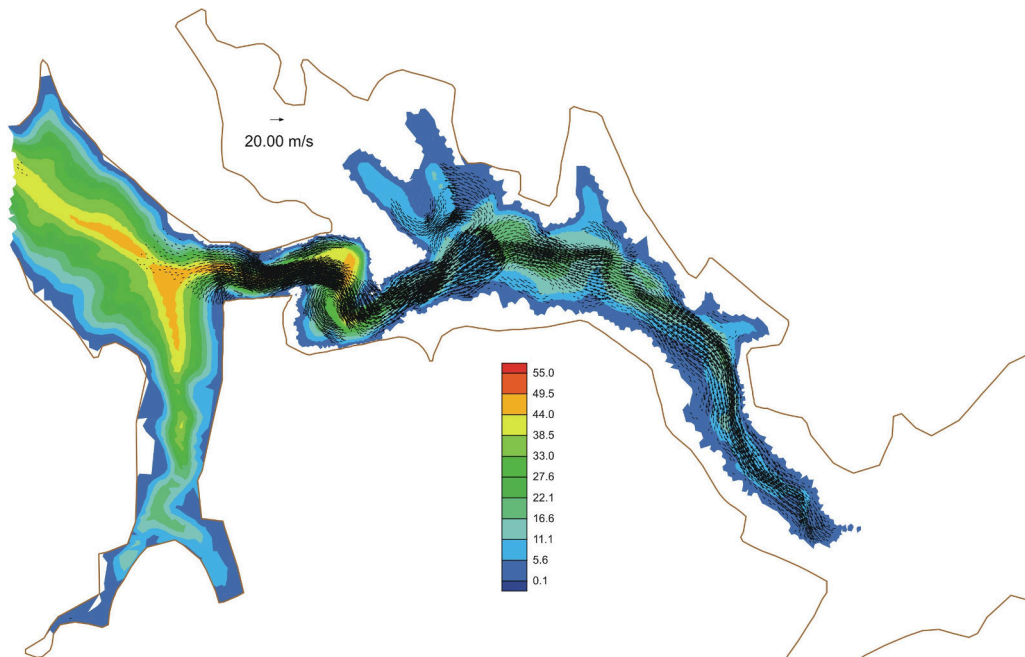

Figure 1.39 H_BP_4: Computed water depth and velocities 300 seconds after the dam break.

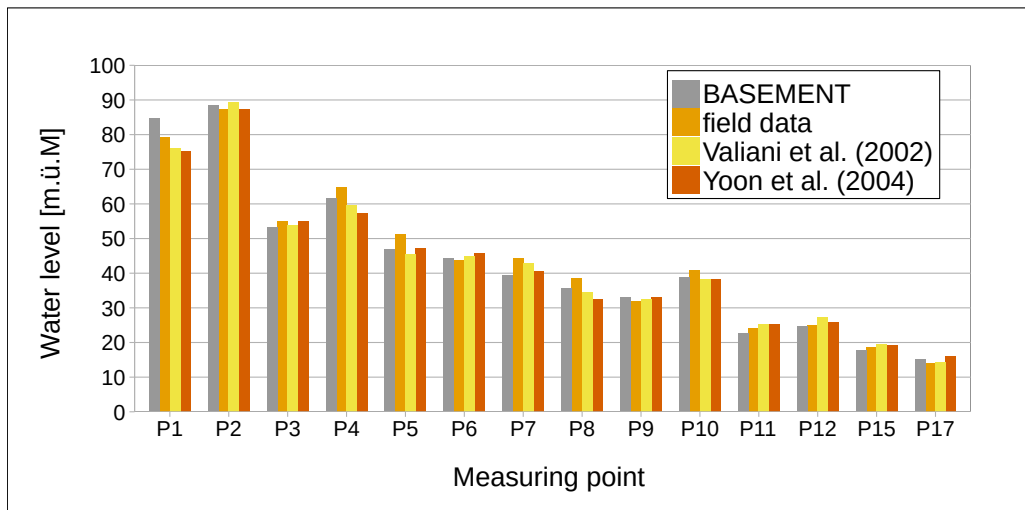

Figure 1.40 H_BP_4: Computed and observed water surface elevation at different control points

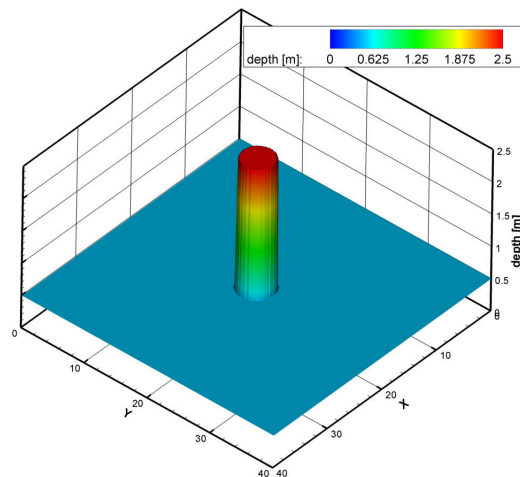

Figure 1.41 *H_BP_5*: Perspective view of the circular dam break wave patterns, $t=0.0s$

which propagates inwards while the primary shock wave continues to propagate outwards with decreasing strength. This secondary shock wave converges to the center and finally implodes. This generates a sharp jump in the surface water elevation at the center ($t = 4.7$ s).

As a result it can be stated that BASEplane is able to reproduce these distinct features of the flow and wave patterns of the 2-D circular dam break. Comparisons with the numerical results of Toro show qualitative agreement of the calculated water surface and velocities profiles. Generally, a more diffusive behaviour is observed compared to Toro's results. This may be attributed to the use of first order Godunov methods and to the use of a lower CFL number in the simulations. Despite the use of a rectangular grid, the cylindrical symmetry of the wave propagations is maintained well. Only at the first moments of the dam break, some water surface modulations can be seen at the crest of the primary shock wave which diminish with proceeding time.

The resulting water surface and velocity profiles of the approximate Riemann solvers match well the results of the exact Riemann solver. Both approximate Riemann solvers, HLL and HLLC, reproduce the flow and wave patterns.

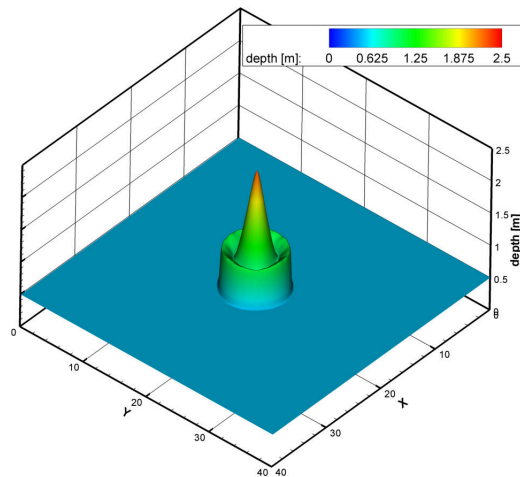

Figure 1.42 H_BP_5: Perspective view of the circular dam break wave patterns, $t=0.4s$

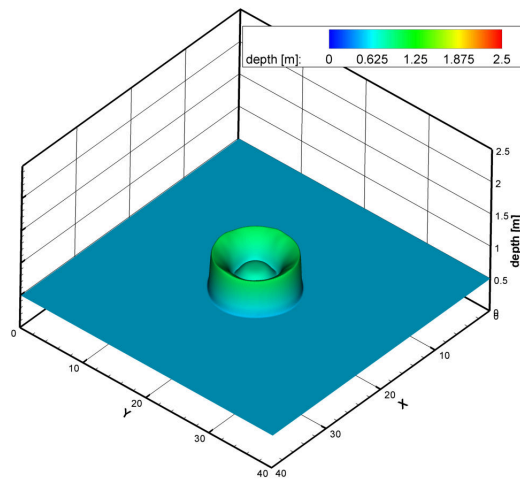

Figure 1.43 H_BP_5: Perspective view of the circular dam break wave patterns, $t=0.7s$

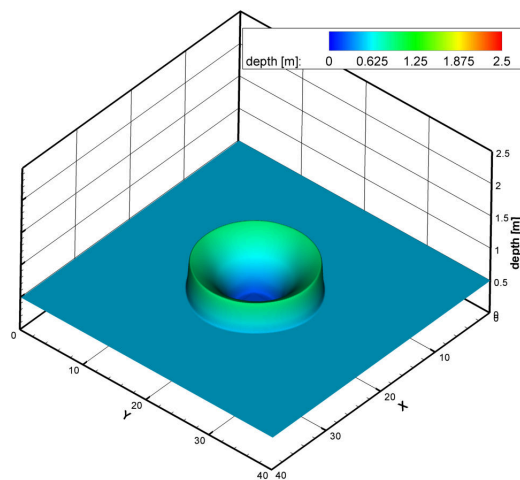

Figure 1.44 H_BP_5: Perspective view of the circular dam break wave patterns, $t=1.4s$

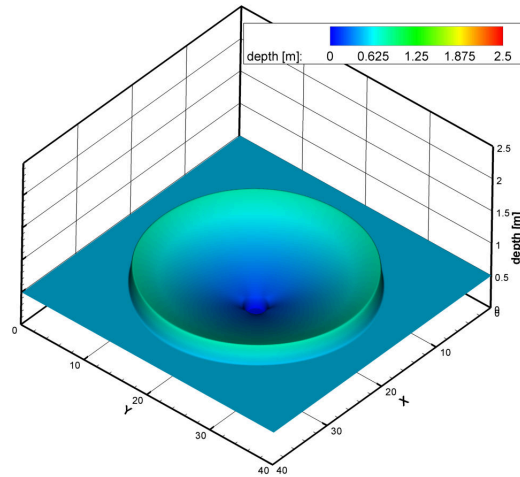

Figure 1.45 H_BP_5: Perspective view of the circular dam break wave patterns, $t=3.5s$

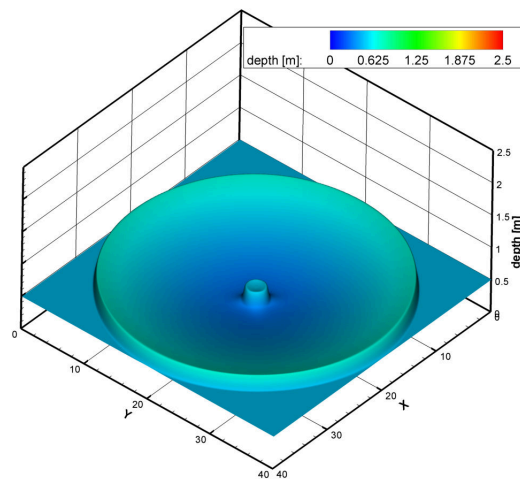

Figure 1.46 H_BP_5: Perspective view of the circular dam break wave patterns, $t=4.7s$

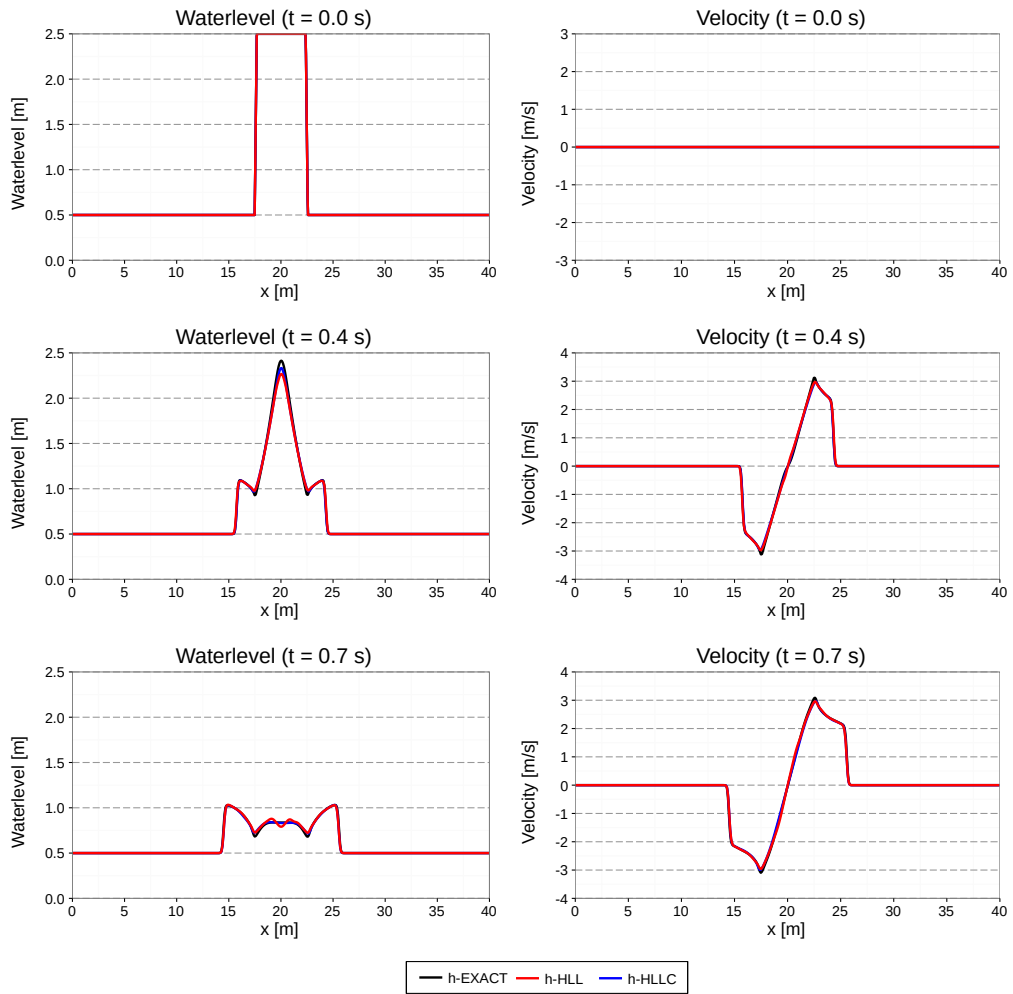

Figure 1.47 H_BP_5 : Water surface along $y=20$ m

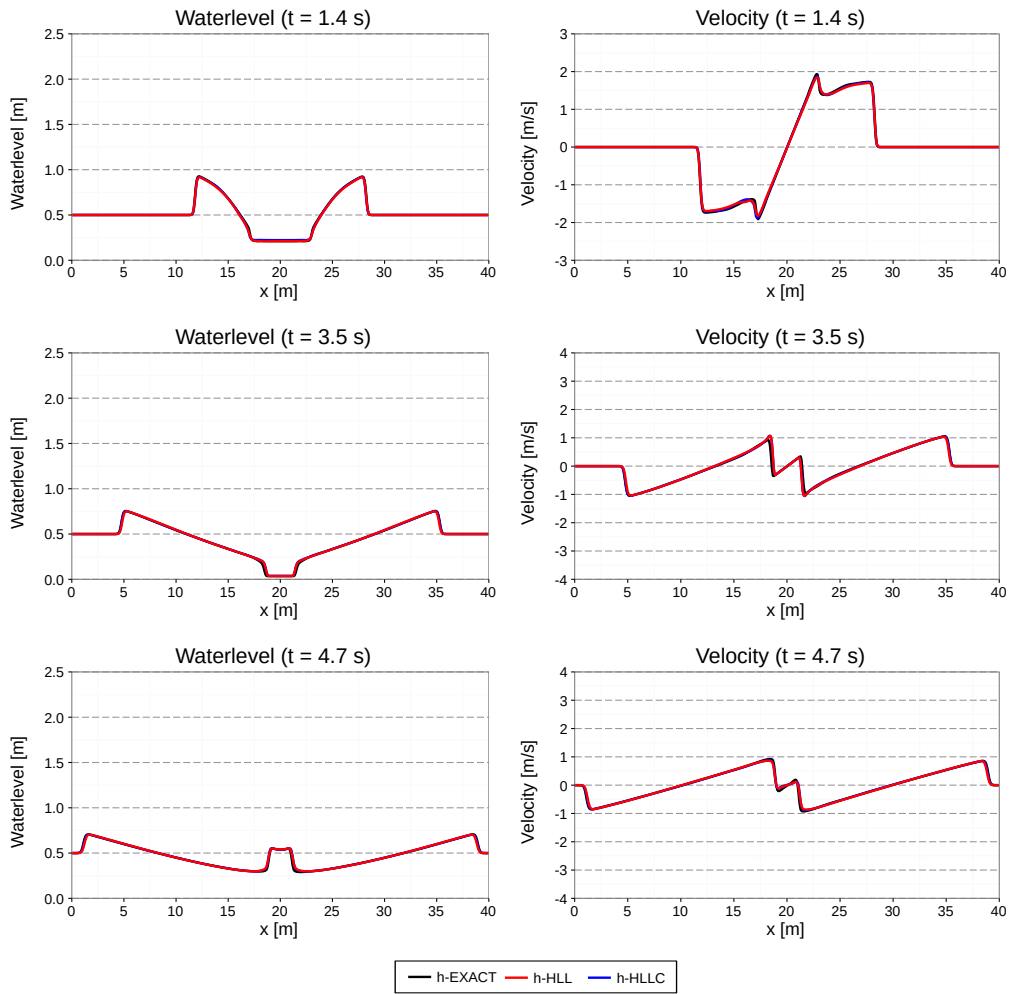

Figure 1.48 H_BP_5: Water surface along $y=20m$

2

Sediment Transport

2.1 Introduction

The test catalogue is intended for the validation of the program. The catalogue consists of different test cases, their geometric and hydraulic fundamentals and the reference data for the comparison with the computed results. The test cases are built up on each other going from easy to more and more complex problems. The sediment transport module is tested against some simple experimental test cases described in Section 2.2. Common test cases are suitable for both, 1-D and 2-D simulations. Specific test cases are intended for either 1-D or 2-D simulations.

2.2 Common Test Cases

2.2.1 ST_1: Soni et al: Aggradation due to overloading

2.2.1.1 Intention

This validation case is intended to reproduce equilibrium conditions for steady flow followed by simple aggradation due to sediment overloading at the upstream end. The test is suitable for 1-D and 2-D simulations and uses one single grain size.

2.2.1.2 Description

Soni et al. (1980) and Soni (1981) performed a series of experiments dealing with aggradations. With this particular test, they determined the coefficients a and b of the empirical power law for sediment transport. This test has been used by many researchers as validation for numerical techniques containing sediment transport phenomena (see e.g. Kassem and Chaudhry (1998), Soulis (2002) and Vasquez et al. (2005)).

The experiments were realized within a rectangular laboratory flume. First, a uniform equilibrium flow is established as starting condition. Then the overloading with sediment starts, resulting in aggradations.

2.2.1.3 Geometry and general data

Length of flume	l_f	20	[m]
Width of flume	w_f	0.2	[m]
Median grain size	d_m	0.32	[mm]
Relative density	s	2.65	[-]
Porosity	p	0.4	[-]

2.2.1.4 Equilibrium experiments

In total, a number of 24 experiments with different initial slopes S have been performed by Soni. Measured values are equilibrium water depth h_{eq} and the sediments equilibrium discharge $q_{B,eq}$. The flow velocity u_{eq} has been computed manually by Soni.

Concerning initial conditions for the equilibrium runs, “the flume was filled with sediment up to a depth of 0.15 m and then was given the desired slope”. The equilibrium is reached, when a uniform flow has established respectively “when the measured bed- and water surface profiles were parallel to each other.” In the average, the equilibrium needed about 4 to 6 hours to develop.

2.2.1.5 Boundary conditions

water flow: constant upstream flow discharge q_{in} and a weir on level 0 at the downstream end. Alternatively, a ghost cell may be used downstream, where the total flux into the last cell leaves the computational domain.

sediment: periodic boundary conditions are applied. The inflow $q_{B,in}$ upstream equals the outflow $q_{B,out}$ downstream.

From now on, we refer to the Soni test case #1, as the entire data for all experiments would go beyond the scope of this section. Measured data for the equilibrium are

q_{in}	4.0	$[m^3/(s \cdot m)] \times 10^{-3}$
S	3.56	$[-] \times 10^{-3}$
h_{eq}	5.0	$[m] \times 10^{-2}$
$q_{B,eq}$	12.1	$[m^3/(s \cdot m)] \times 10^{-6}$
u_{eq}	0.4	$[m/s]$

The establishment of the same equilibrium conditions is achieved by calibrating e.g. the hydraulic friction. As soon as the simulation data looks similar to the measured results, the aggradation can be started.

2.2.1.6 Aggradation experiments

After the equilibrium has been reached, the sediment feed was increased upstream by an overloading factor of $q_B/q_{B,eq}$. This factor is different for each experiment. For test case #1, it was set to 4.0. The flow discharge remains the same as in the equilibrium case. Due to the massive sediment overloading, aggradation starts quickly at the upstream end. Measured data is available for the bottom elevation at certain times.

2.2.2 ST_2 : Saiedi

2.2.2.1 Intention

Similar to the Soni test case, this validation deals with aggradation due to sediment overloading. However, compared to Soni, the sediment input is considerably greater than the carriage capacity of the flow and an aggradation shock is forming. The test verifies whether the computational model can handle shocks within the sediment phase. Again, a single grain size is used.

2.2.2.2 Description

The experiments were conducted in a laboratory flume located at the Water Research Laboratory, School of Civil Engineering, University of New South Wales, Australia. Geometric details and results are reported in Saiedi (1981a) and Saiedi (1981b). Saiedi did two separate tests, one in a steady flow and one in a rapidly unsteady flow with varying sediment supply. Only the steady case is of our interest here.

2.2.2.3 Geometry and general data

The sediment used was of fairly uniform size with the median grain size $d_{50} = 2$ mm, relative density $s = 2.6$ and porosity at bed $p = 0.37$.

The test section was about 18 m long in a 0.61 m wide glass-sided flume with a slope of 0.1 %. The flow was fed with a sediment-supply of constant rate using a vibratory feeder. The sediment input rate was chosen to be greater than the transport capacity of the flow, therefore resulting in the formation of an aggradation shock sand-wave travelling downstream. The downstream water level was maintained constant by adjusting the downstream gate.

2.2.2.4 Calibration

Before starting the sediment feed, at first, the aim is a uniform flow which fulfils a measured flow discharge q and the corresponding water depth h . This can be achieved by adjusting e.g. the hydraulic friction coefficient from Manning n . From the experiments, Saiedi proposes a calibration estimate of $n=0.0136 + 0.0170 q$. Note that there is no sediment layer at the calibration phase.

As initial conditions, start with a fluid at rest and a uniform flow depth of $h_0 = 0.223$ m on the sloped flume. The flow feed rate upstream is constant at $q_{in} = 0.098$ m³/s. At the

downstream boundary, the water level is kept constant at $h = 0.223$ m “by adjusting the downstream gate”.

2.2.2.5 Aggradation

As soon as a uniform flow with constant water depth is established, the sediment feed upstream can be started. It remains constantly on $q_B = 3.81$ kg/min. The results for the steady state computation are available at $t = 30$ min and $t = 120$ min. To avoid cluttering, the plots of the measured bed levels have been averaged.

2.2.3 BeST_3 : Guenter

2.2.3.1 Intention

The Günter test series deals with degradation in a laboratory flume. The experiments were conducted using a multiple grain size distribution. The reported results allow for a validation of the bed topography and the behaviour of heterogeneous sediment transport models.

2.2.3.2 Description

Günter performed some tests at the Laboratory of Hydraulics, Hydrology and Glaciology at the ETH Zurich using sediment input with a multiple grain size distribution. His aim was to determine a critical median shear stress of such a grain composition.

Günter was interested in the behaviour of different grain classes but also in the steady ultimate state of the bed layer, when a top layer has developed and no more degradation occurs with the given discharge. As initial state, a sediment bed with a higher slope than the slope in the steady case is used. There is no sediment feed but a constant water discharge. The bed then starts rotating around the downstream end resulting in a steady, uniform state with an armouring layer.

The validation is based on the resulting bed topography and the measured grain size distribution of the armouring layer at the end of the simulation.

2.2.3.3 Geometry and general data

Guenter actually investigated several test cases with different grain compositions and boundary conditions. This test case corresponds to his experiment No.3 with the grain composition No.1.

The experiment was conducted in a straight, rectangular flume, 40 m long, 1 m width with vertical walls. At the downstream end, the flume opens out into a slurry tank with 8 m length, 1.1 m width and 0.8 m depth (relative to the main flume), where the transported sediment material is held back. The sediment bed has an initial slope of 0.25 % with an initial grain size distribution given by

d_g [cm]	Mass fraction [%]
0.0 - 0.102	35.9
0.102 - 0.2	20.8
0.2 - 0.31	11.9
0.31 - 0.41	17.5
0.41 - 0.52	6.7
0.52 - 0.6	7.2

2.2.3.4 Simulation procedure and boundary/initial conditions

First of all, the domain gets filled slowly with fluid until the highest point is wet. The weir on the downstream end is set such that no outflow occurs. After the bed is completely under water, the inflow discharge upstream is increased successively during 10 minutes up to the constant discharge of 56.0 l/s. At the same time, the weir downstream is lowered down to a constant level until the water surface elevation remains constant in the outflow area. There is no sediment inflow during the whole test.

Using this configuration, the bed layer should rotate around the downstream end of the soil. The experiment needed about 4 to 6 weeks until a stationary state was reached. The data to be compared with the experiment are final bed level and final grain size distribution.

2.3 BASEchain Specific Test Cases

2.3.1 ST_BC_1: Advection of suspended load

2.3.1.1 Intention

This test is intended to verify the quality of the advection schemes. The aim is to minimize the numerical diffusion even over long distances.

2.3.1.2 Description

In a rectangular channel with steady flow conditions the advection of the suspended material is observed, once for a vertical front of concentration (case A) and once for a concentration with a Gaussian distribution (case B). The Quickest, Holly-Preissmann and MDPM-Scheme are tested. The diffusion is set to 0 and there is no sediment exchange with the soil.

2.3.1.3 Geometry and initial conditions

- The computational area is a rectangular channel with 10 km length, 30 m width and a slope of 0.5 ‰. The cell width Δx is 40 m.
- The initial condition for the hydraulics is a steady discharge of 10 m³/s
- The initial conditions for the suspended load are the following:

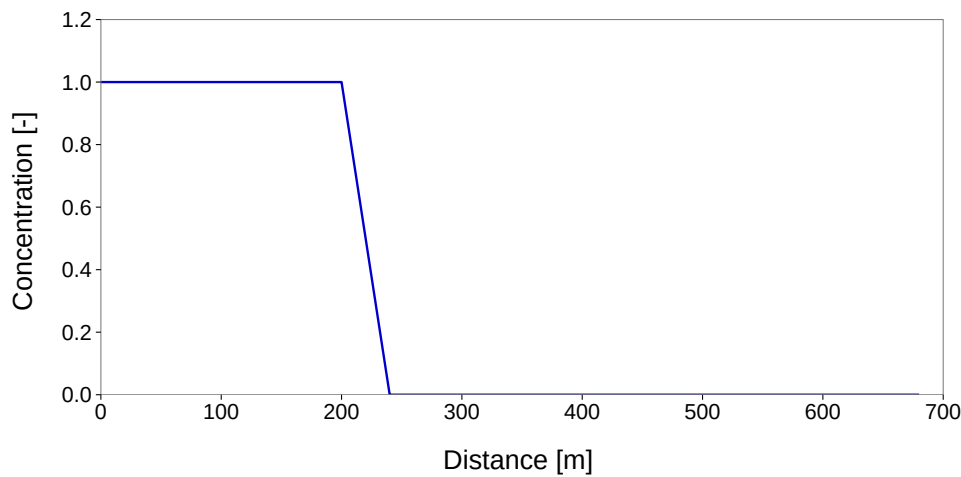

Figure 2.1 *ST_BC_1: Initial condition for case A*

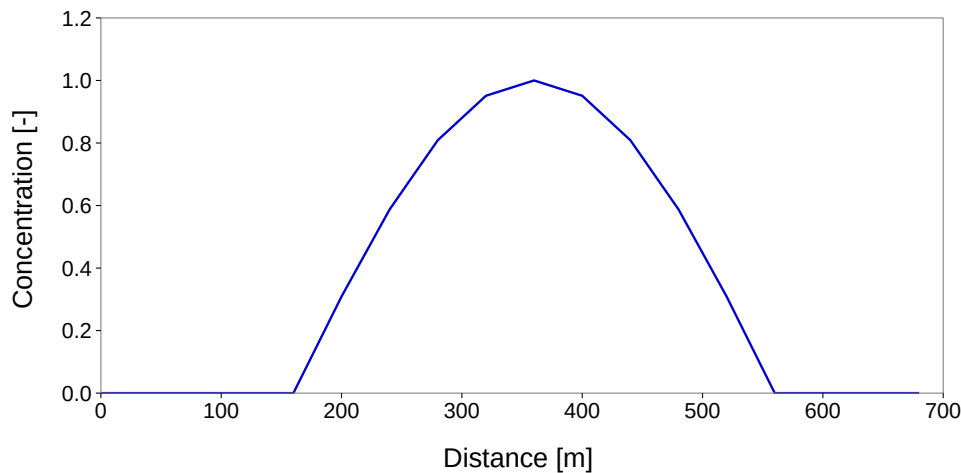

Figure 2.2 *ST_BC_1: Initial condition for case B*

Case A: The concentration is 1 for the first 200 meters of the flume and 0 for the rest.

Case B: The concentration has a Gauss-distribution on the upstream part of the flume.

2.3.1.4 Boundary conditions

- The friction expressed as k_{Str} is 80.
- The hydraulic upper Boundary is a hydrograph with steady discharge of $10 \text{ m}^3/\text{s}$.
- The hydraulic outflow boundary is h-q-relation directly computed with the slope.
- The upper boundary condition for suspended load is a constant inflow concentration of 1 for case A and 0 for case B.
- The lower boundary condition is an outflow concentration corresponding to the concentration in the last cell.

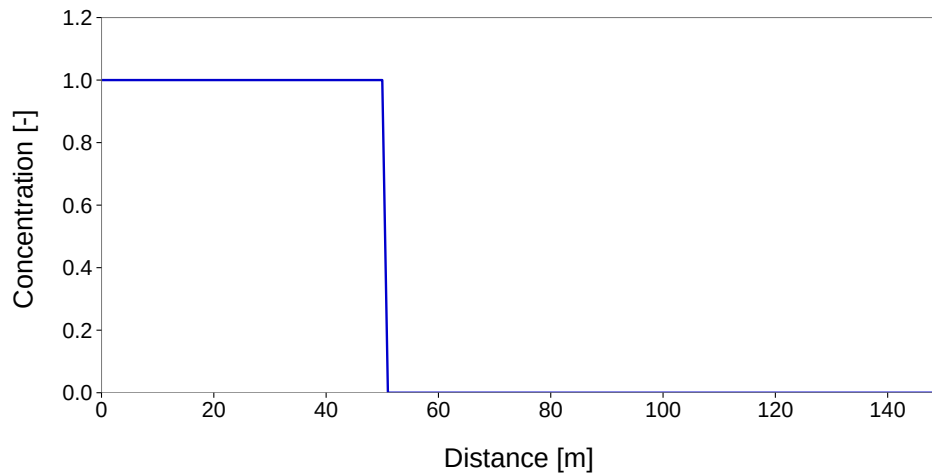

Figure 2.3 ST_BC_2: Initial condition for case A

2.3.2 ST_BC_2: Advection-Diffusion

2.3.2.1 Intention

This test is intended to verify the combination of advection and diffusion for suspended load for a given diffusion factor Γ .

2.3.2.2 Description

In a rectangular channel with steady flow conditions the behaviour of the suspended material is observed, once for a vertical front of concentration (case A) and once for a concentration with a Gaussian distribution (case B). The Quickest, Holly-Preissmann and MDPM-Scheme are tested. There is no sediment exchange with the soil.

2.3.2.3 Geometry and initial conditions

- The computational area is a rectangular channel with 1000 length, 20 m width and a slope of 1 ‰. The friction expressed as k_{Str} is 30. The cell width Δx is 1 m.
- The initial condition for the hydraulics is a steady discharge of 50 m³/s.
- The initial conditions for the suspended load are:

Case A: The concentration is 1 for the first 50 meters of the flume and 0 for the rest.

Case B: The concentration has a Gauss-distribution on the upstream part of the flume.

2.3.2.4 Boundary conditions

- The friction is expressed as k_{Str} is 30.
- The hydraulic upper boundary is hydrograph with steady discharge of 50 m³/s.
- The hydraulic outflow boundary is h-q-relation directly computed with the slope.

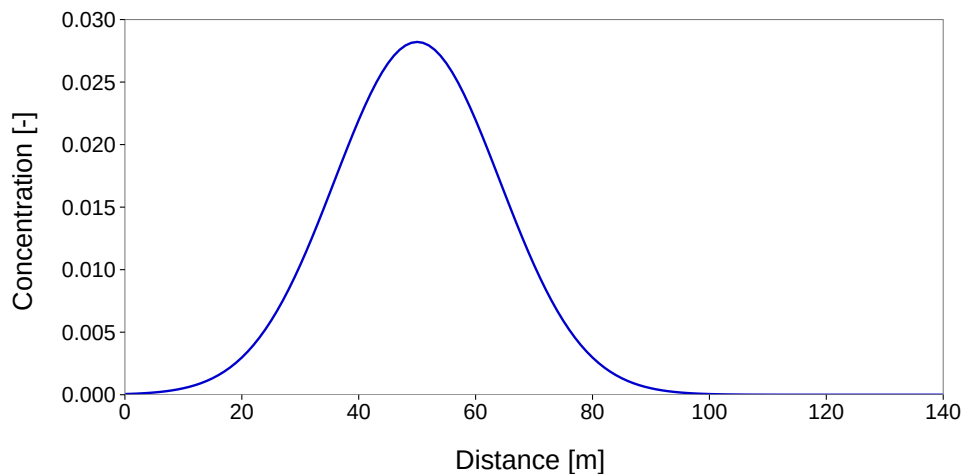

Figure 2.4 ST_BC_2: Initial condition for case B

- The upper boundary condition for suspended load is a constant inflow concentration of 1 for case A and 0 for case B.
- The lower boundary condition is an outflow concentration corresponding to the concentration in the last cell.

2.4 BASEplane Specific Test Cases

2.4.1 ST_BP_1: Advection of suspended load

2.4.1.1 Intention

This test is intended to verify the quality of the advection scheme. The aim is to minimize the numerical diffusion even over long simulation time or distance.

2.4.1.2 Description

In a rectangular channel with steady flow conditions the advection of the suspended material is observed, once for a vertical front of concentration (case A) and once for a concentration with a Gaussian distribution (case B). The MDPM-Scheme is tested. The diffusion is set to 0 and there is no sediment exchange with the soil.

2.4.1.3 Geometry and initial conditions

- The computational area is a rectangular channel with 1 km length, 10 m width and a slope of 7 ‰.
- The initial condition for the hydraulics is a steady discharge of 50 m³/s.
- The initial conditions for the suspended load are the following:

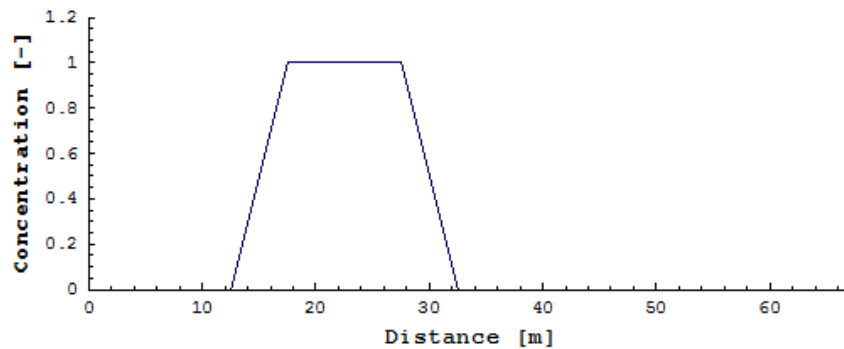

Figure 2.5 ST_BP_1: Initial condition for case A

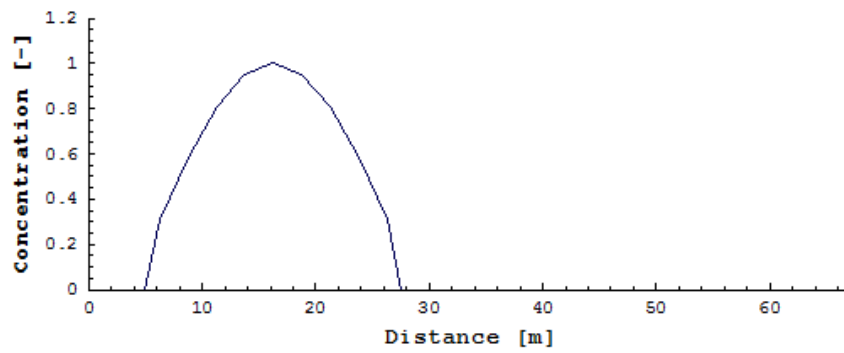

Figure 2.6 ST_BP_1: Initial condition for case B

Case A: The concentration is 1 for the first 30 meters at the upper end of the channel. During the simulation a constant sediment source is added to maintain between 15 and 20 meters from the upstream end to maintain a constant concentration.

Case B: The concentration has a Gauss-distribution on the upstream part of the flume.

2.4.1.4 Boundary conditions

- The friction is expressed as Manning factor n is 0.03.
- The upper boundary is a hydrograph with steady discharge of $50 \text{ m}^3/\text{s}$ with concentration 0.
- The hydraulic outflow boundary is zero_gradient.
- The lower boundary condition for suspended load is an outflow concentration corresponding to the concentration in the last cell.

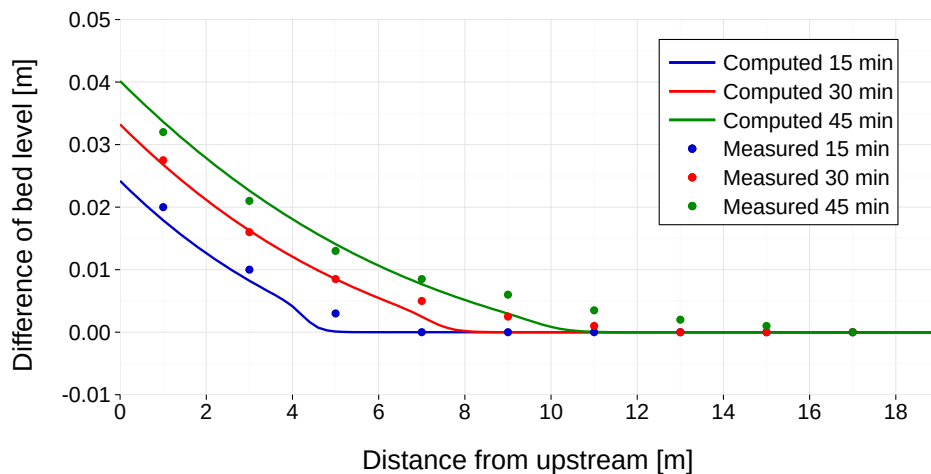

Figure 2.7 Soni Test with MPM-factor = 6.44 (BC)

2.5 Results

2.5.1 Common Test Cases

2.5.1.1 ST_1: Soni

2.5.1.1.1 Results obtained by BASEchain

The Soni test case has been simulated with the MPM approach like the one used for the next test case of Saiedi (see Section 2.2.2). As the equilibrium bed load of $2.42 \cdot 10^{-7} \text{ m}^3/\text{s}$ is known, the MPM-factor has been calibrated to obtain a good agreement for the equilibrium state. This leads to a value of 6.44 for the prefactor in the MPM-formula.

The results show a quite good agreement between experiment and simulation.

2.5.1.1.2 Results obtained by BASEplane

The Soni test case was modelled as single grain computation on a mobile bed with the transport formula of Meyer-Peter & Müller (MPM). The grain diameter is chosen as the mean diameter of the grain mixture used by Soni. The simulations were performed on an unstructured mesh with 1202 triangular elements.

In Soni's experiments at first an equilibrium transport was established within the laboratory flume. The corresponding transport rate observed by Soni is known to be $2.42 \cdot 10^{-7} \text{ m}^3/\text{s}$. Then the sediment inflow was increased to 4 times the equilibrium transport.

To be able to reproduce the experiments, the transport formula must be calibrated to achieve the same equilibrium transport rate. The calibration resulted in a reduction of the pre-factor of the MPM formula from 8 to about 3.3. The critical dimensionless shear stress for incipient motion in the MPM formula is not calibrated here and therefore, per default, determined from the Shields diagram.

The numerical results for the bed aggradations and the water levels are compared with the measurements by Soni. The situations after 15min, 30min and 40min are plotted in the following figures. Generally the numerical results show an acceptable agreement

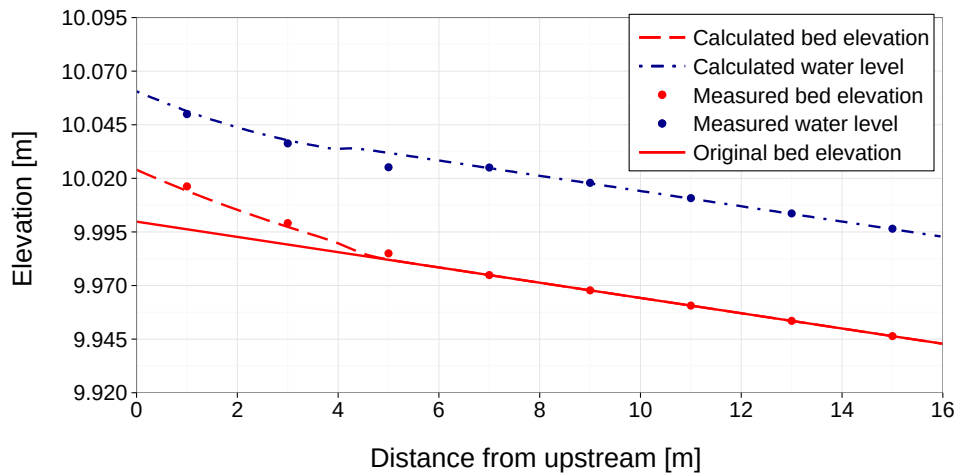

Figure 2.8 *ST_1: Soni Test – Bed aggradation and water level after 15 min (BP)*

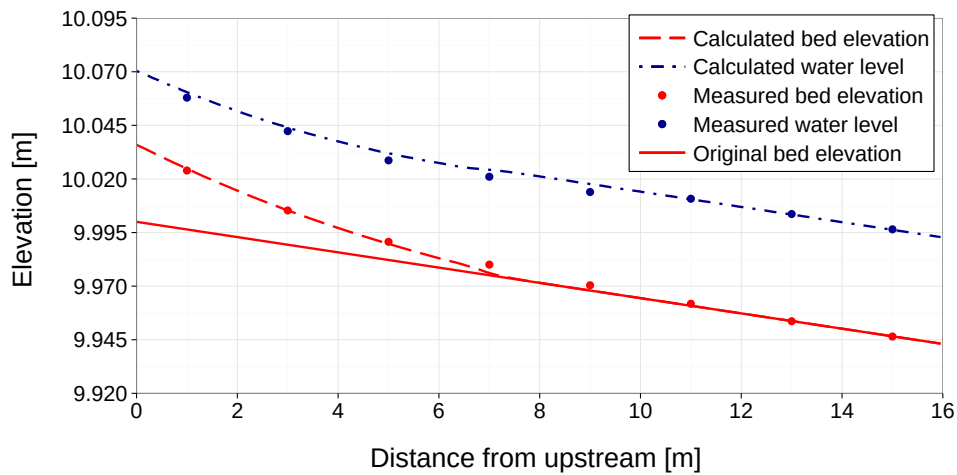

Figure 2.9 *ST_1: Soni Test – Bed aggradation and water level after 30 min (BP)*

with the measured values. Compared to the measurements, the toe of the aggradation front shows a less diffusive smearing behaviour. This may be attributed to the finer grain fractions within Soni's grain mixtures, whose behaviour is not adequately modelled in single grain computation. Also the rather fine diameter of 0.32 mm can be seen as problematic concerning the applicability of the MPM formula, which is best suited for coarse sands and gravel.

2.5.1.2 ST_2: Saiedi

2.5.1.2.1 Results obtained by BASEchain

The Saiedi test was simulated using the Meyer-Peter Müller approach for the sediment flux, which can also be formulated as:

$$q_B = factor(\theta - \theta_{cr})^{3/2} \sqrt{(s-1)gd_m^{3/2}}$$

The factor is usually set around 8.0 and should be between 5 and 15 (Wiberg and Smith,

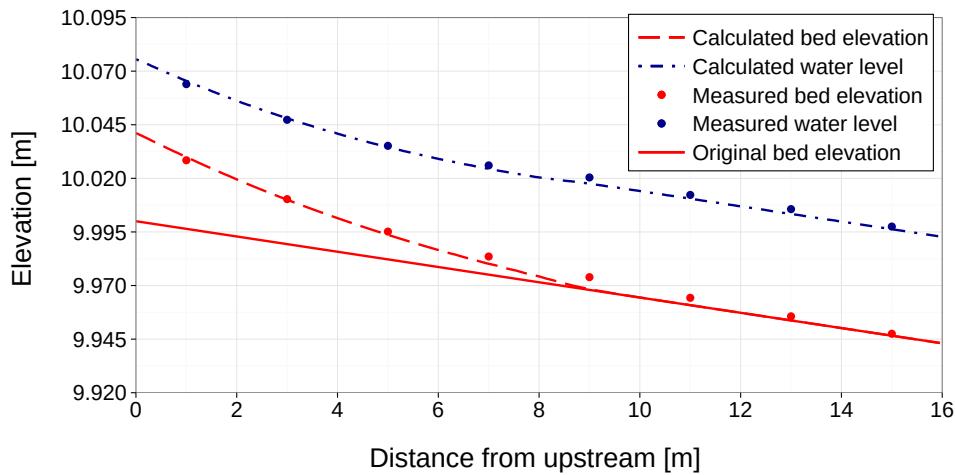

Figure 2.10 *ST_1: Soni Test – Bed aggradation and water level after 40 min (BP)*

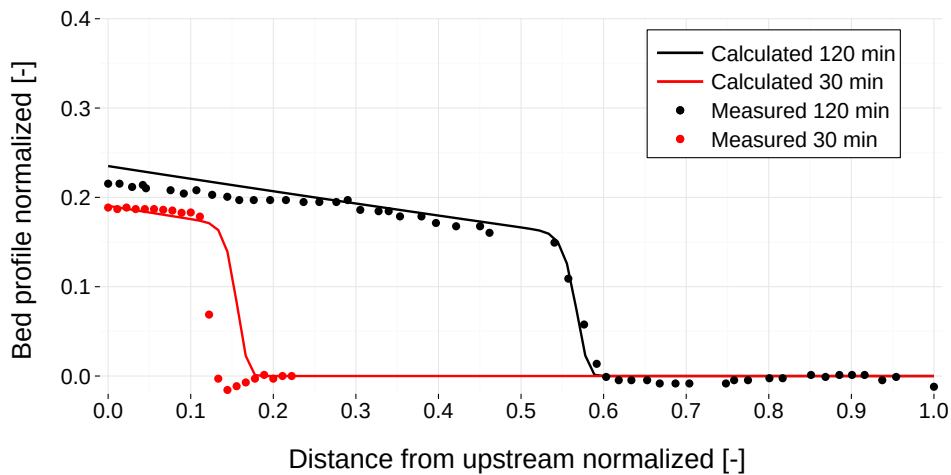

Figure 2.11 *Saiedi Test, with MPM-factor = 13 (BC)*

1989). In this case it was calibrated to 13.

The results present a good fit. This example shows that, to reproduce this type of transport, the approach of MPM approach needs calibration.

2.5.1.2.2 Results obtained by BASEplane

The Saiedi test case was simulated using a single grain approach on an unstructured mesh made of 768 triangles. The Meyer-Peter & Müller formula was used to determine the bedload transport. The simulation was performed on a fixed bed, where no erosion can take place.

To obtain a reasonable fit between the measured values and the simulation results the pre-factor of the transport formula again had to be reduced from 8 to about 5. Furthermore, the simulations show that the sediment is transported too rapidly out of the flume compared to the experiments. To compensate for this effect the critical Shields factor for incipient motion is increased to 0.055, instead of using the value from the Shields diagram.

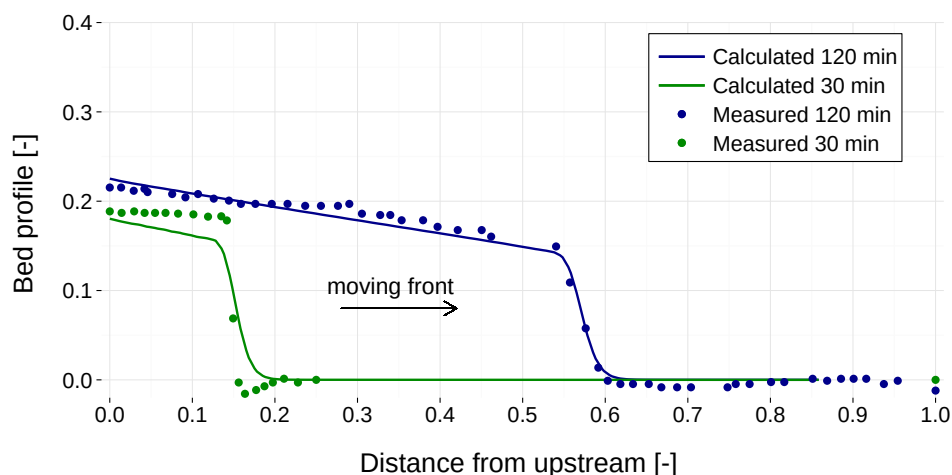

Figure 2.12 *ST_2 : Saiedi Test, propagation of sediment front (BP)*

With these adjustments, the shape and the propagation speed of the sediment front are captured well and Saiedi's results can be reproduced with good accuracy. The front of the sediment bore does not smear over the time but remains steep during the propagation.

2.5.1.3 ST_3: Guenter

2.5.1.3.1 Results obtained by BASEchain

For mixed materials, the Guenter test case has been performed. The initial slope was chosen to be 0.25 % - this corresponds to the full experiment of Guenter.

The eroded material is eliminated from the end basin by a sediment sink. The active layer height is 5 mm and the critical dimensionless shear stress (for beginning of sediment transport) is set to the default value of 0.047. After 200 hours, there are no more important changes recognizable. After the results of Guenter the slope at the final equilibrium state should be the same as the initial one.

The final slope in the numerical model is in good agreement with the final slope observed in the physical experiment. Moreover the grain sorting effect can be modelled quite well. The final grain size distribution is slightly coarser than the observed grain size distribution in the physical model (Figure 2.14).

There are many parameters which influence this result, especially the choice of the critical shear stress and the active layer thickness. Again, this example shows, one has to use different approaches for sediment transport with different values for the free parameters. Quite often, a sensitivity analysis may give a better insight in the behaviour of certain formulas and their parameters.

2.5.1.3.2 Results obtained by BASEplane

The Guenter test has been numerically modelled with 6 different grain classes. The sediment transport capacity has been determined with Hunziker's formula for graded transport. The critical dimensionless shear stress for beginning of sediment transport is set to the default value of 0.047 in Hunziker's formula. This bedload formula was not further adjusted for

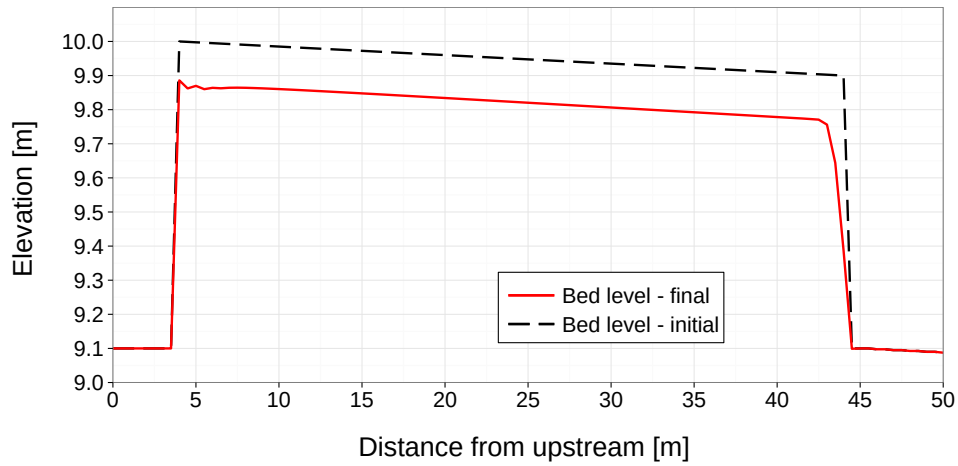

Figure 2.13 ST_3: Guenter Test: equilibrium bed level (BC)

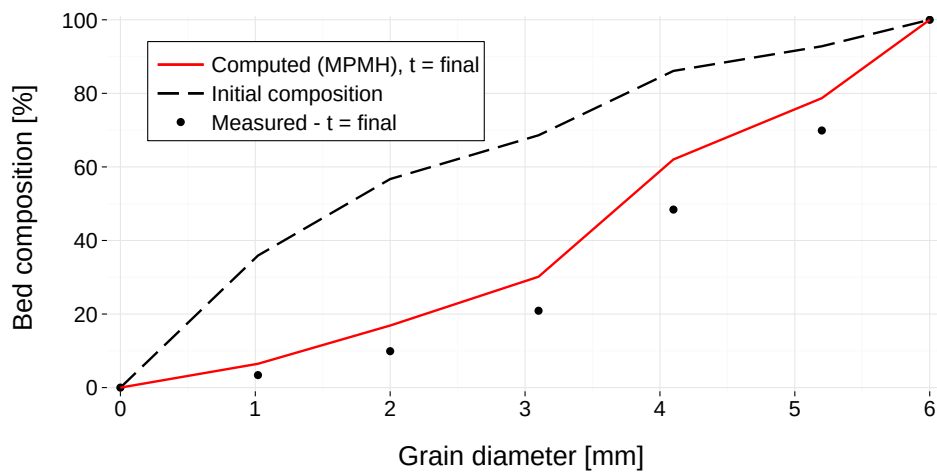

Figure 2.14 ST_3: Guenter Test: grain size distribution (BC)

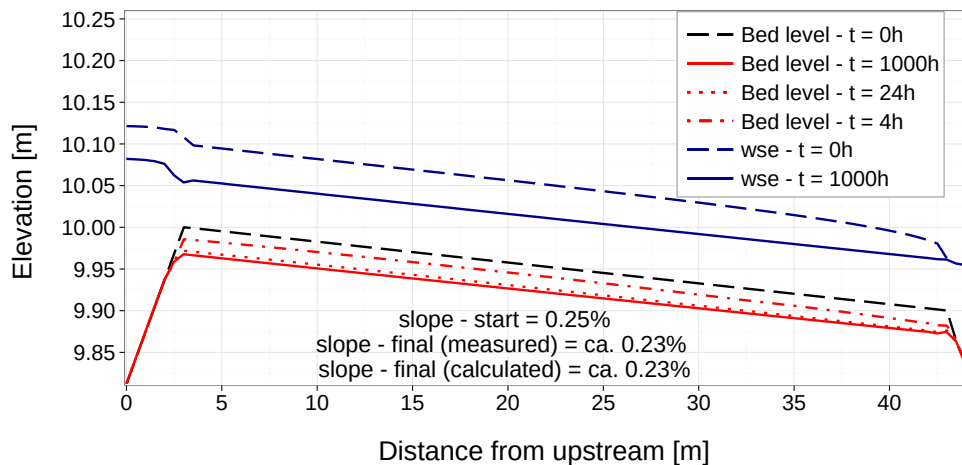

Figure 2.15 *ST_3: Guenter Test: equilibrium bed level (BP)*

the simulations and used with its default values for the pre-factor ($=1.0$) and the exponent of the hiding exponent ($=-1.5$).

The experimental flume has a mobile bed and is modelled with 312 rectangular elements. The channel parts in front and behind the experimental flume, are set to fixed bed elevations in this simulation. The sediment which leaves the mobile bed and enters the fixed bed section is removed using a sediment sink. The thickness of the bedload control volume is set to a constant value of 5 mm. The choice of the thickness of the bedload control volume shows large impacts on the simulation results. An increased thickness here results in larger erosion and a finer composition of the final bed armour.

The mobile bed is eroded during the simulation until finally an armouring layer of coarser materials is formed which prevents further erosions. The final slope of the bed is nearly constant with a value of 0.23%, which is slightly smaller than the original slope of 0.25%. This result is in agreement with the observations made by Guenter. Also the rotation of the bed surface around the downstream end of the flume can be observed during the simulation.

Figure 2.16 shows the measured and computed grain compositions, whereas the latter was taken from the upstream end of the flume. The simulated grain size distribution (red curve) shows a good qualitative agreement with the measured distribution by Guenter (blue dots). But a trend can be seen that the computed composition is slightly too fine. Finally, it can be said, that the numerical model seems capable of reproducing the sorting effects and seems able to simulate the formation of an armouring bed layer.

Beside the results obtained with the Hunziker's transport formula, Figure 2.16 presents also the resulting grain distributions obtained with Wu's transport formula (green curve). Here it can be seen that the finer fractions are eroded too strongly, but a qualitative agreement is obtained. For the simulations with the Wu formula the same critical shear stress of 0.047 was used, and the default settings of the bed load factor ($=1.0$) and the default exponent of the hiding-and exposure coefficient ($=-0.6$) were set. But to enable similar erosion volumes as obtained with the Hunziker's formula, the thickness of the bed load control volume was increased to 2.5 cm.

To check for the mass conservation properties a comparison was made between the initial

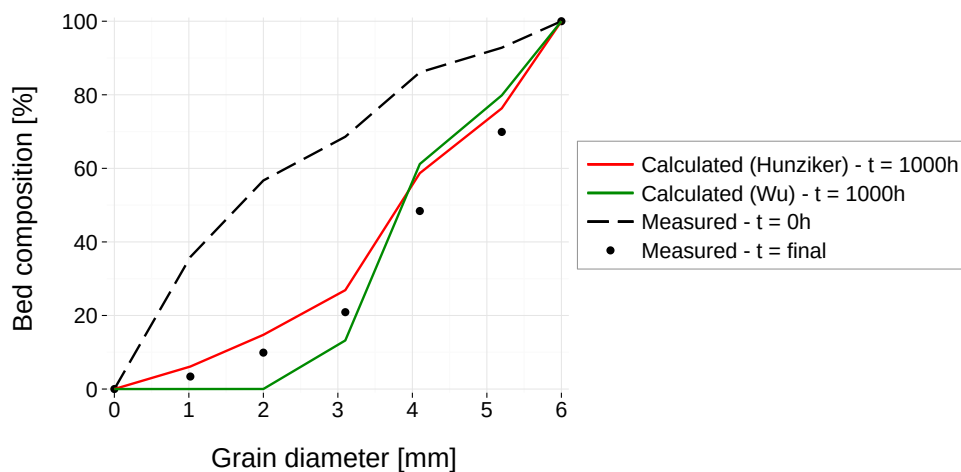

Figure 2.16 ST_3: Guenter Test: grain size distribution (BP)

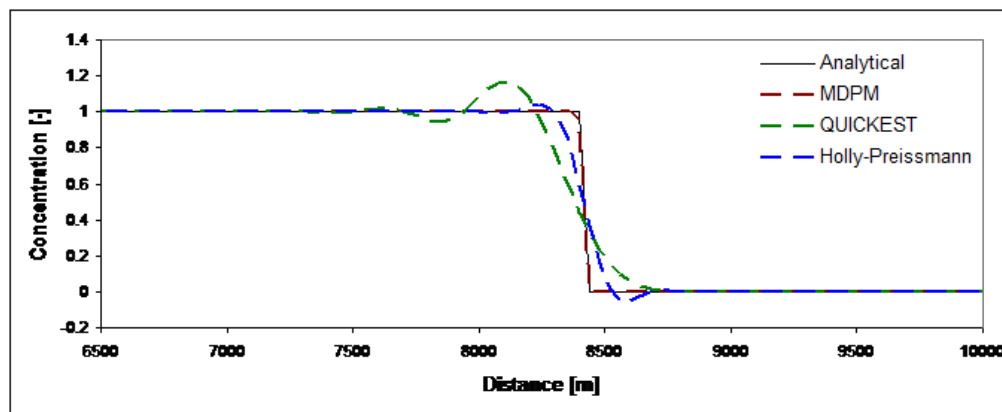

Figure 2.17 ST_BC_1: case A, concentration after 9060 s

sediment volumes in the flume and the final sediment volumes, under regard of all removed sediment volumes. Despite the long run time, the simulation proves to be conservative regarding the sediment transport. Since the experiment has a constant inflow rate and quasi-steady flow conditions, the ‘hydro_step’ approach can be used here which allows a reduction of several orders of magnitude in simulation time.

2.5.2 BASEchain specific Test Cases

2.5.2.1 ST_BC_1: Advection of suspended load

The advection test has been executed for the QUICK, the QUICKEST, the Holly-Preissmann and the MDPM-scheme. The results of the QUICK-scheme are not illustrated as they are very instable.

Case A: Figure 2.17 shows the concentration front after 9060 s or after 8200 m of way. The results show that the big issue of the advection simulation, the numerical diffusion, is almost completely avoided by the MDPM scheme.

Case B: Figure 2.18 shows the concentration front after 9772.5 s or after 8843 m of way. For

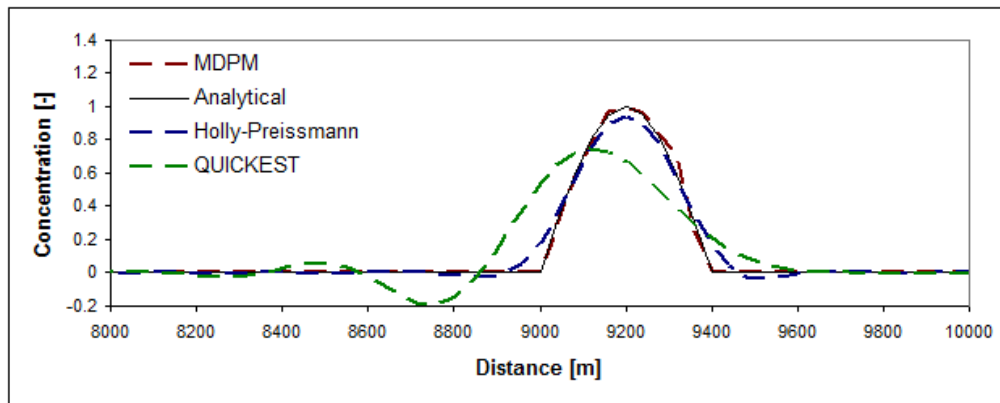

Figure 2.18 ST_BC_1: case B, concentration after 9772.5 s

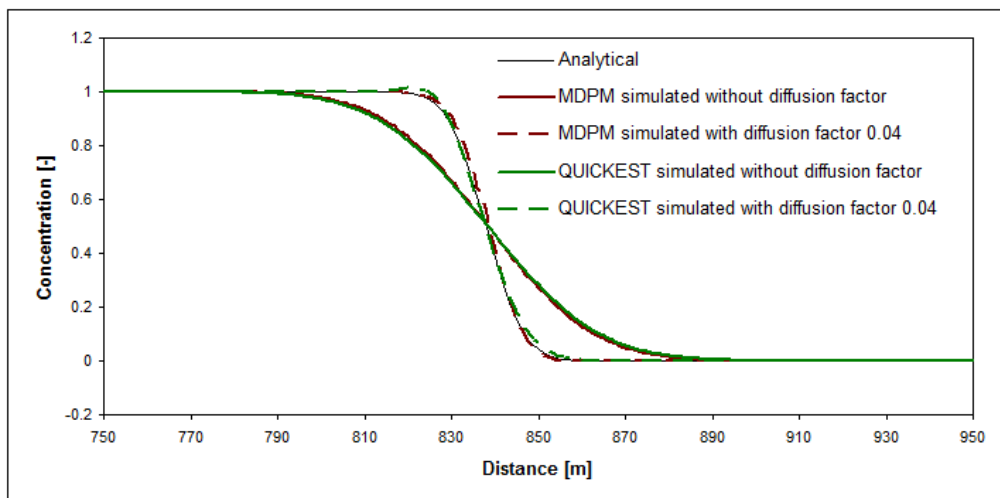

Figure 2.19 ST_BC_2: case A, concentration after 605 s

the MDPM scheme there are some local deviations from the analytical solution. These are due to the discretisation and do not increase with time and distance. The initial maximal concentration is conserved.

2.5.2.2 ST_BC_2: Advection-Diffusion

The Advection Test has been executed for the QUICKEST, and the MDPM-scheme. Figure 2.19 and Figure 2.20 show the concentration front of case A and the Gauss distribution for case B after 605 s or after 788 m away. The diffusion factor is 0.04 for case A and 0.1 for case B. The result of the simulation with the internally computed diffusion is also illustrated, but there is no analytical solution to compare.

The results are satisfying. The QUICKEST scheme gives here a result which is nearly as good as the one of the MDPM scheme, but this is due to the short simulation time. Its deviation from the exact solution due to numerical diffusion increases with the time like shown in test ST_BC_1.

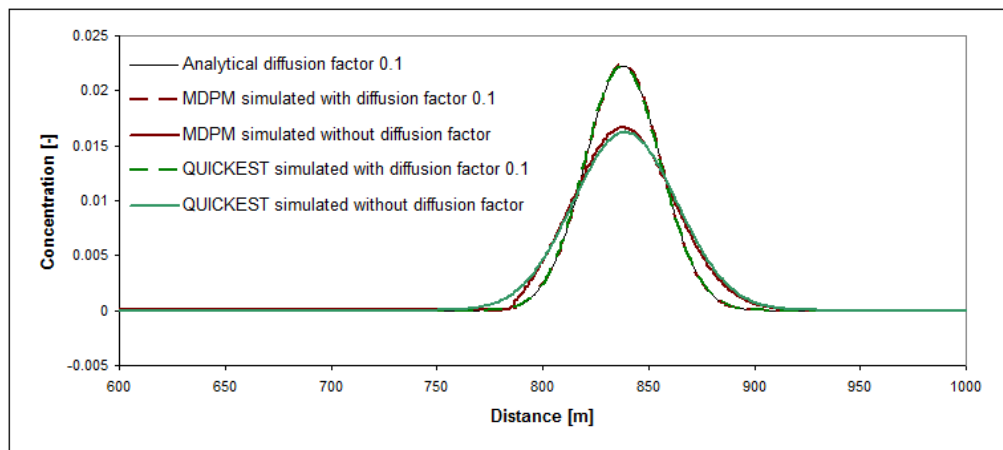

Figure 2.20 *ST_BC_2: case B, concentration after 605 s*

2.5.3 BASEplane specific Test Cases

2.5.3.1 ST_BP_1: Advection of suspended load

To test the advection of suspended sediment transport, the MDPM-scheme has been applied.

Case A: Figure 2.21 shows the concentration front after 200 s or after 730 m of distance travelled. The results show that there is no oscillation before and after the front. The diffusion is small and mainly due to the irregular discretisation.

Case B: Figure 2.22 shows the concentration front after 200 s or after 700 m of distance travelled. The maximum of the Gauss distribution is conserved and there are no oscillations near the steep gradients.

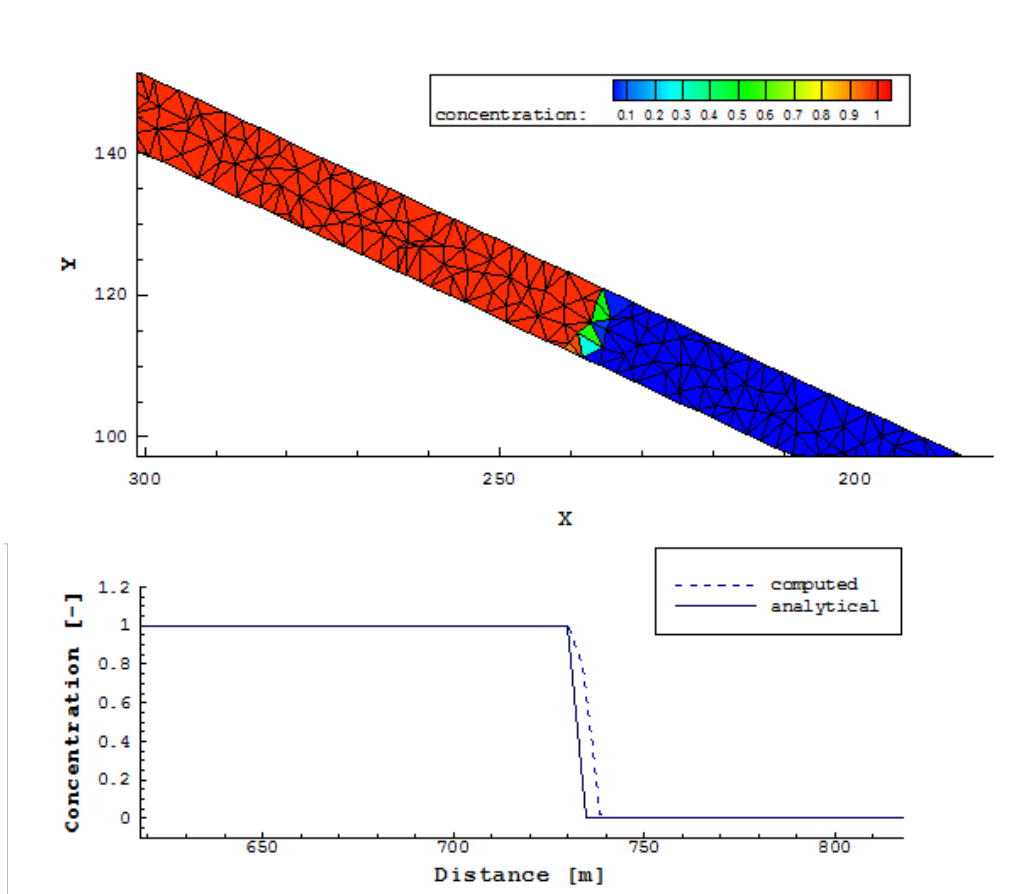

Figure 2.21 ST_BC_1: case A, concentration after 200 s

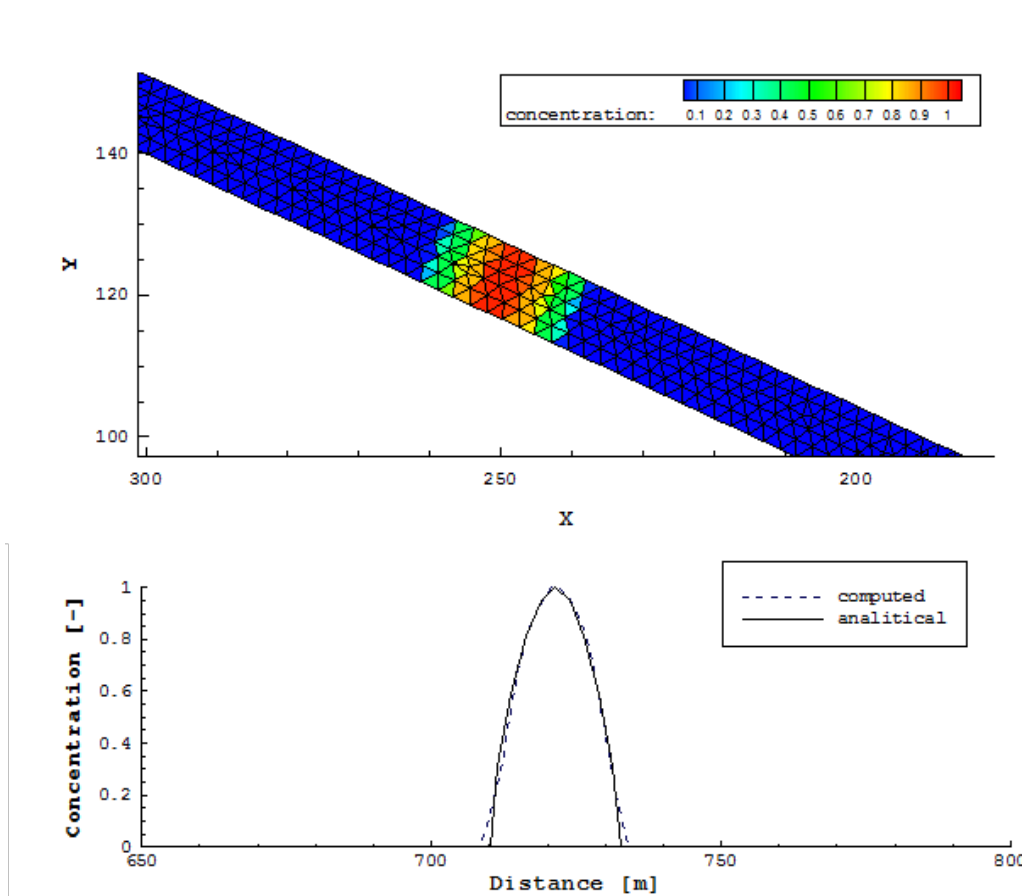

Figure 2.22 ST_BP_1: case B, concentration after 200 s

Model Coupling

3.1 Coupling of Domains of Same Type

3.1.1 COUPL_1: Sequential two-way coupling with backwater effects

3.1.1.1 Intention

This test is intended to verify and test the coupling mechanism of a sequential coupling with mutual data exchange between the sub-domains.

3.1.1.2 Description

Two sub-domains are simulated in a combined simulation. Sub-domain A is situated upstream of sub-domain B (Figure 3.1). Both sub-domains are coupled using a two-way coupling mechanism via an outflow hydrograph boundary and an inflow hydrograph boundary. Discharges are passed to the downstream sub-domain and water surface elevations are passed in upstream direction. Backwater effects travel in direction of the upstream sub-domain, caused by an outflow weir at the downstream end.

3.1.1.3 Geometry and initial conditions

- Case A: 1-D \rightarrow 1-D coupling
Both channels have trapezoidal cross sections and 1 km length, 40 m base width and a slope of 1.25 ‰.
- Case B: 2-D \rightarrow 2-D coupling
Both channels have rectangular cross sections, 1 km length, 40m width and a slope of 1.25 ‰.
- Initially the sub-domains are dry.

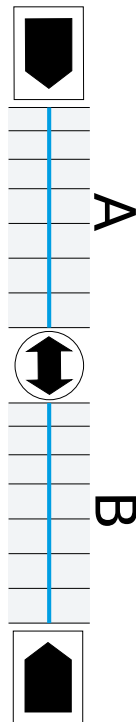

Figure 3.1 Sub-domains A and B

3.1.2 COUPL_2: River network modelling

3.1.2.1 Intention

This test is intended to verify and test the coupling mechanism of a junction and a bifurcation in a simple river network configuration.

3.1.2.2 Description

Five sub-domains are simulated in a combined simulation (Figure 3.2). Sub-domains A and D are situated upstream and have an inflow hydrograph defined. Both river branches merge together into the sub-domain B. At its downstream end sub-domain B splits up into sub-domains E and C. The junction and the bifurcation are simulated with one-way couplings, i.e. the upstream sub-domains are not influenced by the water elevations in the downstream sub-domains.

3.1.2.3 Geometry and initial conditions

- All channels have trapezoidal cross sections, 1 km length, 40 m base width and a slope of 1.25 ‰.
- Initially all sub-domains are dry.

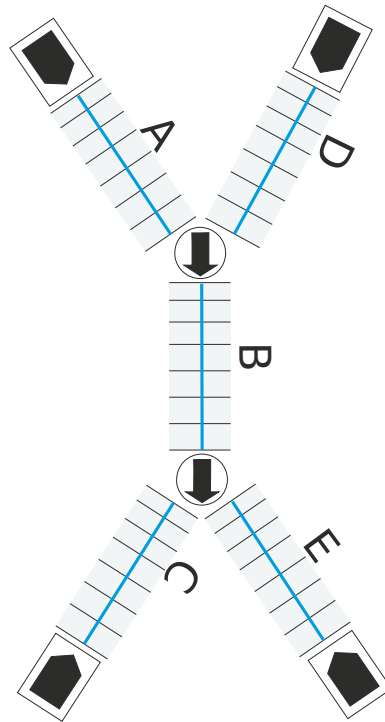

Figure 3.2 Five sub-domains

3.1.3 COUPL_3: Sequential coupling with sediment transport

3.1.3.1 Intention

This test is intended to verify and test the coupling mechanism of a sequential coupling in a morphological simulation with bed load and suspended load transport.

3.1.3.2 Description

Sub-domain A is situated upstream of sub-domain B (Figure 3.1). Both sub-domains are coupled using a 1-way coupling mechanism via an outflow h_q -relation boundary and an inflow hydrograph boundary. Both sub-domains simulate single grain bed load transport. The bed load and suspended load are exchanged over the sequential coupling using corresponding outflow and inflow boundary conditions. At the upstream end of sub-domain A discharge, bed load and suspended load enter with constant rates.

3.1.3.3 Geometry and initial conditions

- Both channels have trapezoidal cross sections and 1 km length, 40 m base width and a slope of 1.25 ‰.
- The initial conditions for the hydraulics are uniform flow conditions in both sub-domains.
- The initial conditions for the bed load transport are set to equilibrium conditions (using IODown and IOup boundary conditions).

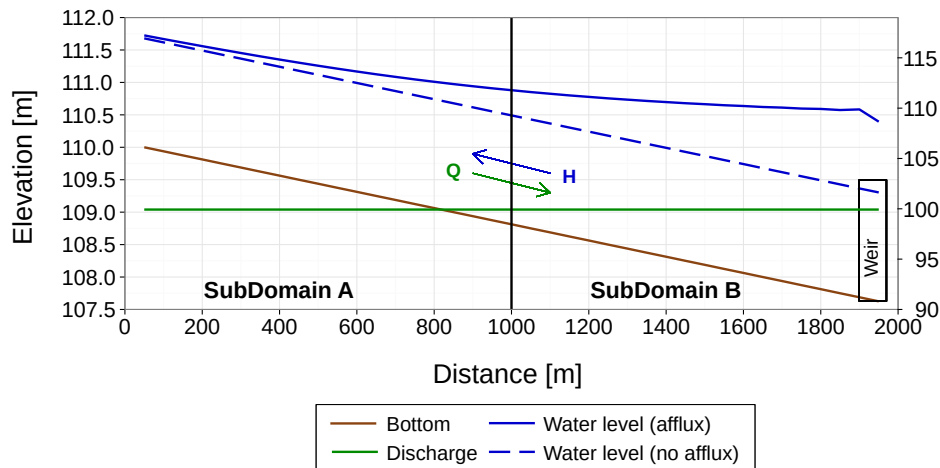

Figure 3.3 *COUPL_1_BC: Water surface elevation and discharge profiles of coupled BASEchain sub-domains A and B*

- The initial condition for the suspended sediment transport is set to concentration 0.0.

3.2 Results

3.2.1 Coupling Test Cases for Domains of Same Type

3.2.1.1 COUPL_1: Sequential two-way coupling with backwater effects

3.2.1.1.1 COUPL_1_BC: Results obtained by BASEchain

The coupling test case has been simulated starting from dry conditions in sub-domains A and B. Discharge is passed into downstream direction and water surface elevations are passed into upstream direction (two-way coupling).

After some time steady state conditions are reached in the coupled simulation. The backwater curve travels seamlessly from the downstream sub-domain into the upstream sub-domain. The discharge is constant over the whole domain. This indicates a correct two-way coupling which is capable to consider backwater effects from downstream.

3.2.1.1.2 COUPL_1_BP: Results obtained by BASEplane

As in the 1-D case, this coupling test case has been simulated starting from dry conditions in sub-domains A and B. Discharge is passed in downstream direction and water surface elevations are passed in upstream direction (two-way coupling).

After some time steady state conditions are reached in the coupled simulation. The backwater curve again enters seamlessly the upstream sub-domain. The velocity has no jumps at the interface between the sub-domains and it reduces in direction of the downstream weir.

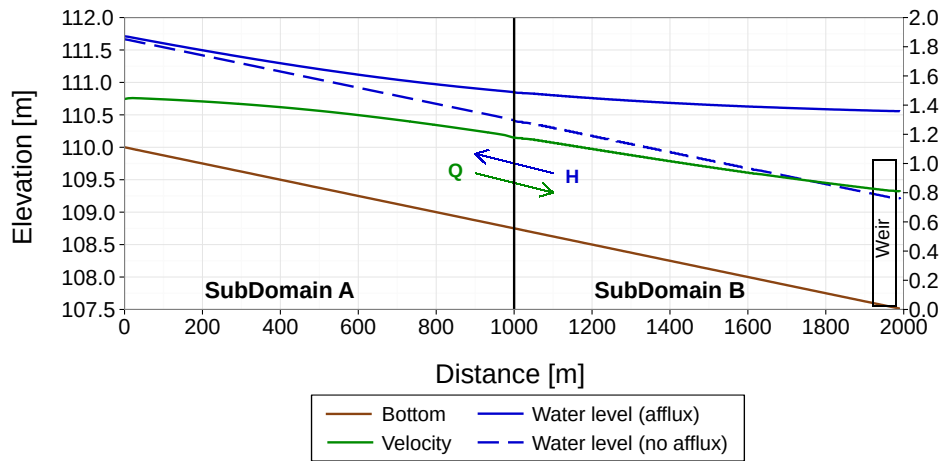

Figure 3.4 *COUPL_1_BP*: Water surface elevation and discharge profiles of coupled BASEplane sub-domains A and B

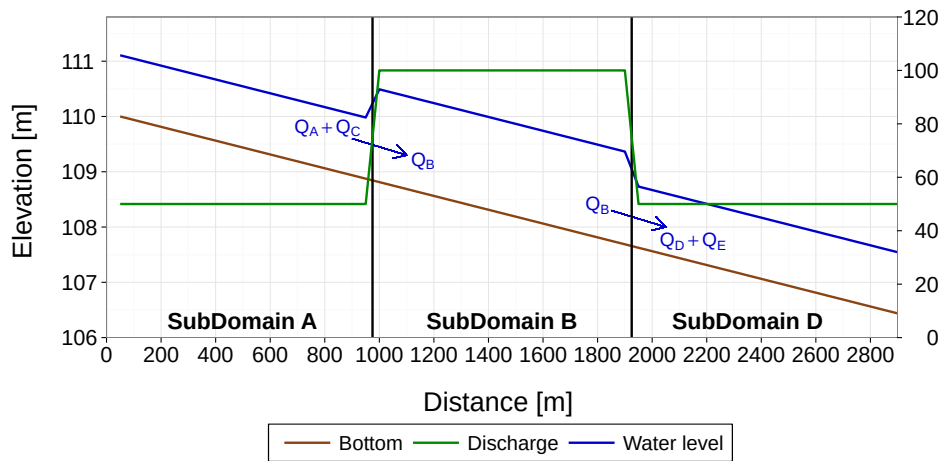

Figure 3.5 *COUPL_2*: Water surface elevation and discharge profiles in the coupled river network

3.2.1.2 COUPL_2: River network modelling

This test case has been simulated starting from dry conditions in all sub-domains. Sub-domains A and C have inflow hydrographs defined and sub-domains D and E have uniform outflow conditions defined. The discharge is passed in downstream direction using a one-way coupling, i.e. influences of downstream water levels are neglected here.

Figure 3.5 shows steady state conditions reached in the coupled simulation. The discharges leaving sub-domains A and C flow together at a junction and pass their discharge into sub-domain B. Sub-domain B splits up into two downstream sub-domains D and E (Figure 3.2). The mass conservation is fulfilled in this simulation and the discharges are distributed correctly among the sub-domains. The water levels show jumps at the coupling interfaces because their influence on the upstream sub-domains was neglected here.

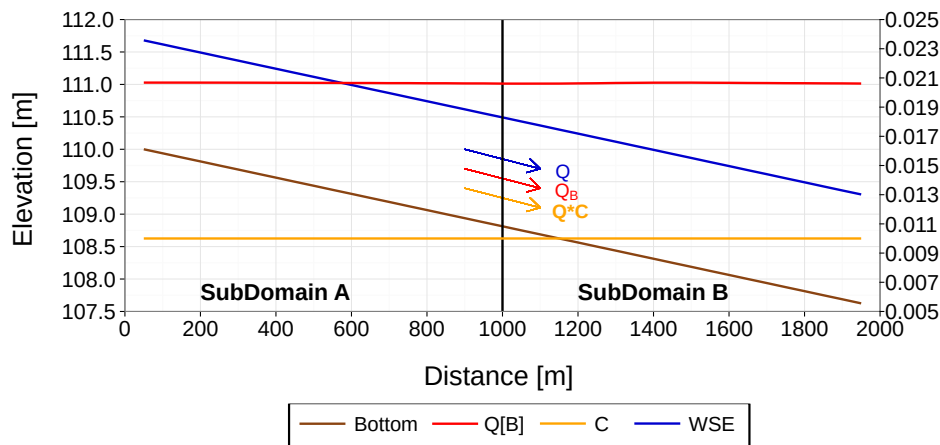

Figure 3.6 *COUPL_3: Bed load transport rate and concentration profile of coupled BASEchain sub-domains A and B*

3.2.1.3 COUPL_3: Sequential coupling with sediment transport

The sub-domains have been simulated starting from uniform flow conditions. Discharge, transported bed load and suspended loads are passed from the upstream sub-domain into downstream direction via boundary conditions. Inflowing discharge and inflow concentration profiles are constant over time. The bed load inflow is set in a way that equilibrium transport is achieved.

The simulation is run until steady state conditions are reached. As can be seen in Figure 3.6, the bed load transport rate is nearly constant in both sub-domains. Also the concentration profiles are the same in the upstream and downstream sub-domains and equal the input concentration profile.

Subsurface Flow

4.1 BASEsub1: Saturated, confined water flow in soil

As a first test case a steady-state subsurface flow on a mesh of $1 \times 0.1 \times 1$ m extension is selected with a cell size of $\Delta x = 0.01$ m. The soil's hydraulic conductivity is set to $k_f = 0.001$ m/s in the computational domain.

At the west boundary a hydrostatic pressure head of $h_w = 5$ m is set as boundary condition. At the east boundary a hydrostatic pressure head of $h_e = 2$ m is set. The other boundary cells are treated as bounce-back boundaries. The numerical constant ϑ is set to 3 and the time step size is selected as $\Delta t = 1$ s. This configuration results in a confined subsurface flow with constant pressure gradient of $\partial h / \partial x = 3$.

The obtained results are illustrated in Figure 4.1, for a cross sectional cut along the y-axis through the domain. The model is able to reproduce the analytical linear gradient of the pore-water pressure head within the domain.

4.2 BASEsub2: Water infiltration into partially-saturated soil

To test the flow in the partially-saturated zone, the unsteady downward propagation of an infiltration front is simulated. This test case was chosen as described by Vogel et al. (2001), in order to allow for comparison with their results obtained with a FE-model. The same test was also successfully modelled with a LBM-approach by Ginzburg et al. (2004).

The domain is discretized with $1 \times 0.1 \times 1$ m extension. The cell size is set to $\Delta x = 0.01$ m. As retention model the approach after Van-Genuchten and Mualem (VGM) is applied. The soil parameters are chosen as $\alpha = 0.8$ 1/m and $n_\nu = 1.09$ based on the tabulated values given in Vogel et al. (2001). The hydraulic conductivity is set to $k_f = 5.55 \text{E-}7$ m/s. A negative hydrostatic pore-water pressure distribution (= soil suction) is set as initial condition with a total head of $h_w + z = -10$ m. At the top of the domain a constant infiltration source

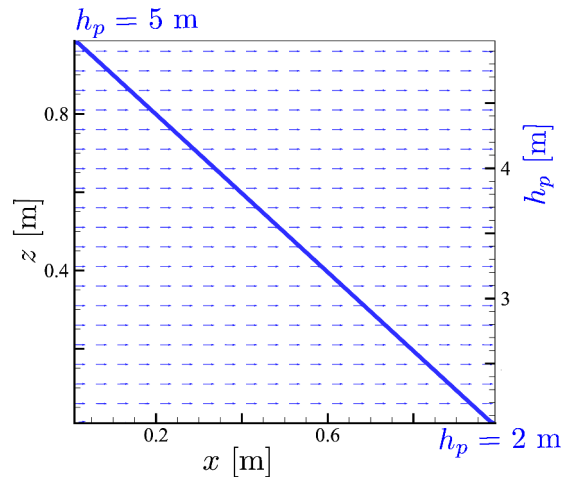

Figure 4.1 BASEsub1: Saturated confined flow through homogenous domain with linear pore-water pressure gradient.

is placed with $q_{inf} = 2.78E-7$ m/s, leading to the formation of an infiltration front. The moisture-formulation is used with $\vartheta = 3$ and a time step size of $\Delta t = 10$ s is selected.

The temporal evolution of the infiltration front was simulated with the air-entry pressure head $h_s = -1E7$ m. The propagation of the infiltration front through is depicted in Figure 4.2 and Figure 4.3. The propagation of the infiltration front obtained with BASEsub (left) is compared with the results obtained with the FE-model by Vogel (right), indicating only negligible deviations. The results also confirm the previously obtained results by Ginzburg.

4.3 BASEsub3: Unsaturated seepage flow

In this setup the 3-D unsteady seepage flow through a laboratory dam is modelled. The experimental investigations were made at the TU Berlin (see Pham Van (2009) for details). The homogeneous dam is 0.6 m high, 4.0 m long and 0.4 m wide. The sand dam material has a hydraulic conductivity of $k_f = 9.5E-4$ m/s (the value given in the reference of $0.95E-4$ m/s is supposed to be a typo). The saturation moisture content of $\theta_s = 0.49$ and a residual water content of $\theta_R = 0.01$ were measured in the laboratory.

The dam is discretized with cubic cells and a cell size $\Delta x = 0.01$ m. As initial condition the measured water content of $\theta_0 = 0.115$ is applied within the whole dam. The air entry pressure is set to $h_s = -0.035$ m. At the upstream embankment slope a time dependent pressure boundary is applied, simulating the rising water level in the reservoir left to the dam. At the downstream embankment slope a seepage boundary is set. The VGM-model is used with $\alpha = 14.5$ 1/m and $n = 2.68$ for sand material. These VGM parameters were chosen with respect to the listed values in Vogel et al. (2001) and are not based on laboratory measurements. For the simulation, the moisture-formulation of the Richard's equation is used with $\vartheta = 3$ and a time step size of $\Delta t = 0.25$ s is selected.

Measured and simulated results of the seepage line are depicted in Figure 4.4 . The temporal development of the seepage line is in accordance between measurement and simulation throughout time.

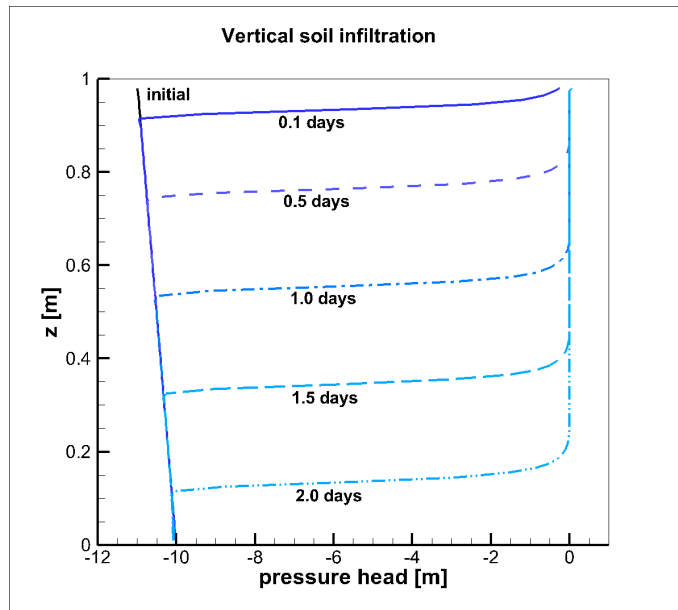

Figure 4.2 BASEsub2: Downward propagation of infiltration front into partially-saturated soil. Simulation results of BASEsub.

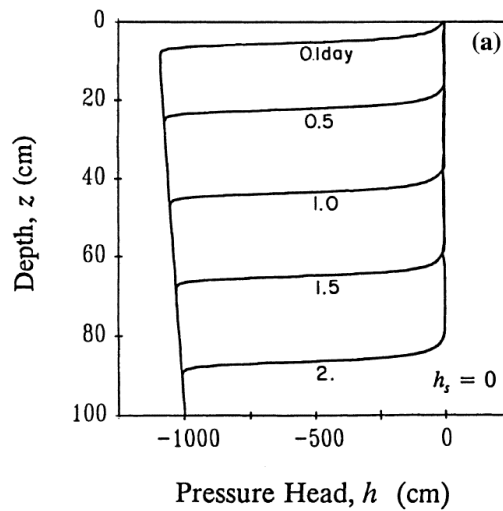

Figure 4.3 BASEsub2: Downward propagation of infiltration front into partially-saturated soil. Results of Vogel et al.

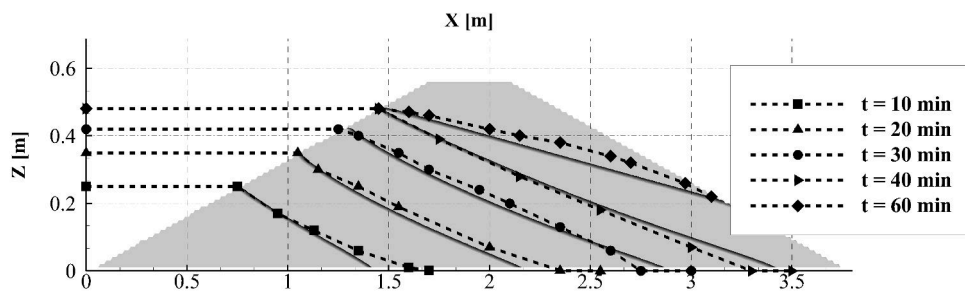

Figure 4.4 BASEsub3: Cross sectional view of measured (dashed) and simulated (bold) development of seepage line, caused by water infiltration due to a rising reservoir at the east dam side.

High-Performance Computing

5.1 Introduction and Backends

5.1.1 Introduction

These test cases present well-defined hydro- and morphodynamic numerical simulations that are used to assess the performance and accuracy of the simulations with BASEMENT High-Performance Computing (BASEHPC). The test cases have an analytical solution to which the numerical solution is compared in order to evaluate the accuracy of the results. The numerical simulations are executed on different backends that influence the performance of the simulation.

5.1.2 Backends

Different backends are used to execute the simulations of the test cases. The different backends are: a central processing unit (CPU) with a sequential application on 1 core, CPU with parallel applications (OpenMP) on 2, 4, 8, 16 and 32 cores and graphic processing units (GPU) with a compute unified device architecture (CUDA) with single and double precision. The features of the GPU card are shown in Table 5.1.

Table 5.1 Features of the GPU hardware used for the numerical simulations

Card	K20	P100	RTX 2080Ti	GTX 1080 Ti	GTX 1070 Ti	GTX 1050 Ti
Memory [GB]	5	12	11	11	8	4
Architecture	Kepler	Pascal	Turing	Pascal	Pascal	Pascal
Bandwidth [GB/s]	208	549	616	484	256	112
CUDA cores	2496	3584	4352	3584	2432	768

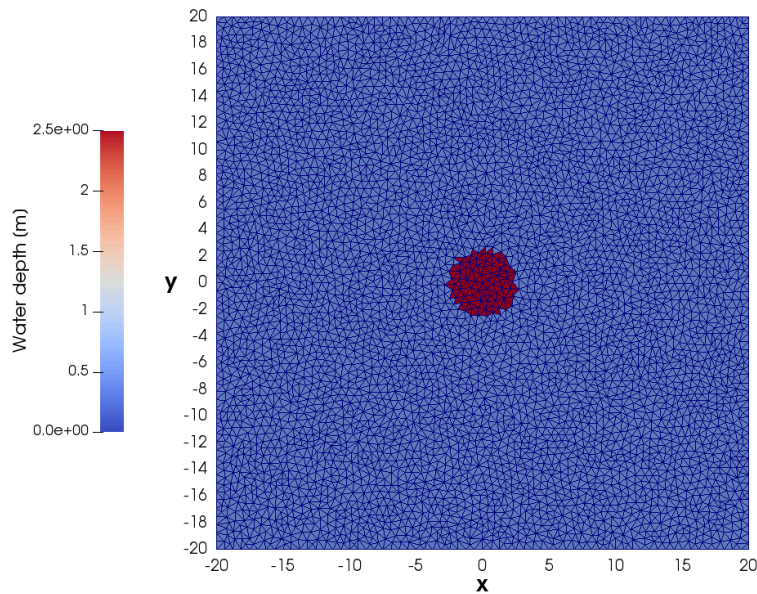

Figure 5.1 Computational domain of the circular dam break (10k cells) with initial water depth.

5.2 Circular dam break

5.2.1 Description

The circular dam break problem represents a 2D Riemann problem based on the sudden collapse of an idealized circular dam over a horizontal bottom. The aim is to evaluate the ability of the model to solve the wave propagation, i.e. the complex interaction of shock and rarefaction waves induced by a dam break event. The results are quantitatively compared with a reference solution obtained as described in Toro (2001).

5.2.2 Geometry and Initial Conditions

The computational domain is a squared area of size 40 x 40 m and composed of unstructured triangular cells. The circular dam has a diameter of 5 m and is located at the center of the computational domain ($x = 0$, $y = 0$). Initially, the water is at rest and the depth inside the circular dam is 2.5 m and 0.5 m over the surrounding domain. No friction and no slope (horizontal bottom) is considered and the CFL number is set to 0.9. As the simulation starts (time 0.0 s), the dam is removed and the subsequent wave pattern is observed during 4.7 s, after which the simulation stops. Different mesh resolutions are used in the test case, the smallest mesh resolution contains exactly 9'927 cells (10k), the second 49'450 cells (50k), the third 99'416 cells (100k), the fourth 497'092 cells (500k) and the finest mesh resolution contains 994'092 cells (1000k). Figure 5.1 shows the initial conditions of the circular dam break with the computational domain of 10k cells.

5.2.3 Results

The evolution of the water depth is described along a reference cross-section located between $(x = -20, y = 0)$ and $(x = 20, y = 0)$, see Figure 5.2. The reference solution is obtained from Toro (2001) using the exact Riemann solver on a mesh of about 1000 cells. After the collapse of the circular dam at $t = 0.0$ s, the primary shock wave propagates outwards. At the same time, a rarefaction wave that propagates towards the center of the dam is observed. The rarefaction wave will implode at the grid center before $t=0.4$ s and then travel in outward direction inducing a rapid drop of the water elevation which will reach a level below the initial outer water surface elevation ($t=1.4$ s) in the center area. The primary shock wave travels outwards with decreasing strength while a secondary shock wave develops in opposite direction towards the center and finally generates a jump in the water depth at the grid center ($t=4.7$ s).

The results on Figure 5.2 show how the solution obtained with BASEMENT version 3 (first order HLLC method) correctly converges to the reference solution as the grid is refined. The cylindrical symmetry of the wave propagation in BASEMENT is maintained, even if water surface modulations are observed along the primary shock wave.

The relative error is computed for the water depth (e_H) and speed (e_u) using eq. 5.1 and for various reference elevations. The result is displayed in Figure 5.3.

$$e_X = \frac{|X_{BM} - X_{ref}|}{X_{ref}} \quad (5.1)$$

Where X stands either for the water surface elevation H or the velocity u with X_{BM} the result of the simulation with BASEMENT and X_{ref} the reference value of Toro (2001).

The relative L^2 norm error (eq. 5.2, e.g Vanzo et al. (2016)) is calculated for each mesh size using the water surface elevation of the simulation result of BASEMENT (H_{BM}) and the references solution (H_{ref}) of Toro (2001). The result is shown on Table 5.2. The relative norm error decreases for finer meshes.

$$L^2 = \sqrt{\frac{\sum_{i=1}^N (H_{ref}(i) - H_{BM}(i))^2}{\sum_{i=1}^N H_{ref}(i)^2}} \quad (5.2)$$

Table 5.2 Relative L^2 norm error of the water surface elevation H compared to the reference solution of Toro (2001) at $t=4.7$ s.

	10k	50k	100k	500k	1000k
L^2	0.1134	0.0523	0.0453	0.0184	0.0145

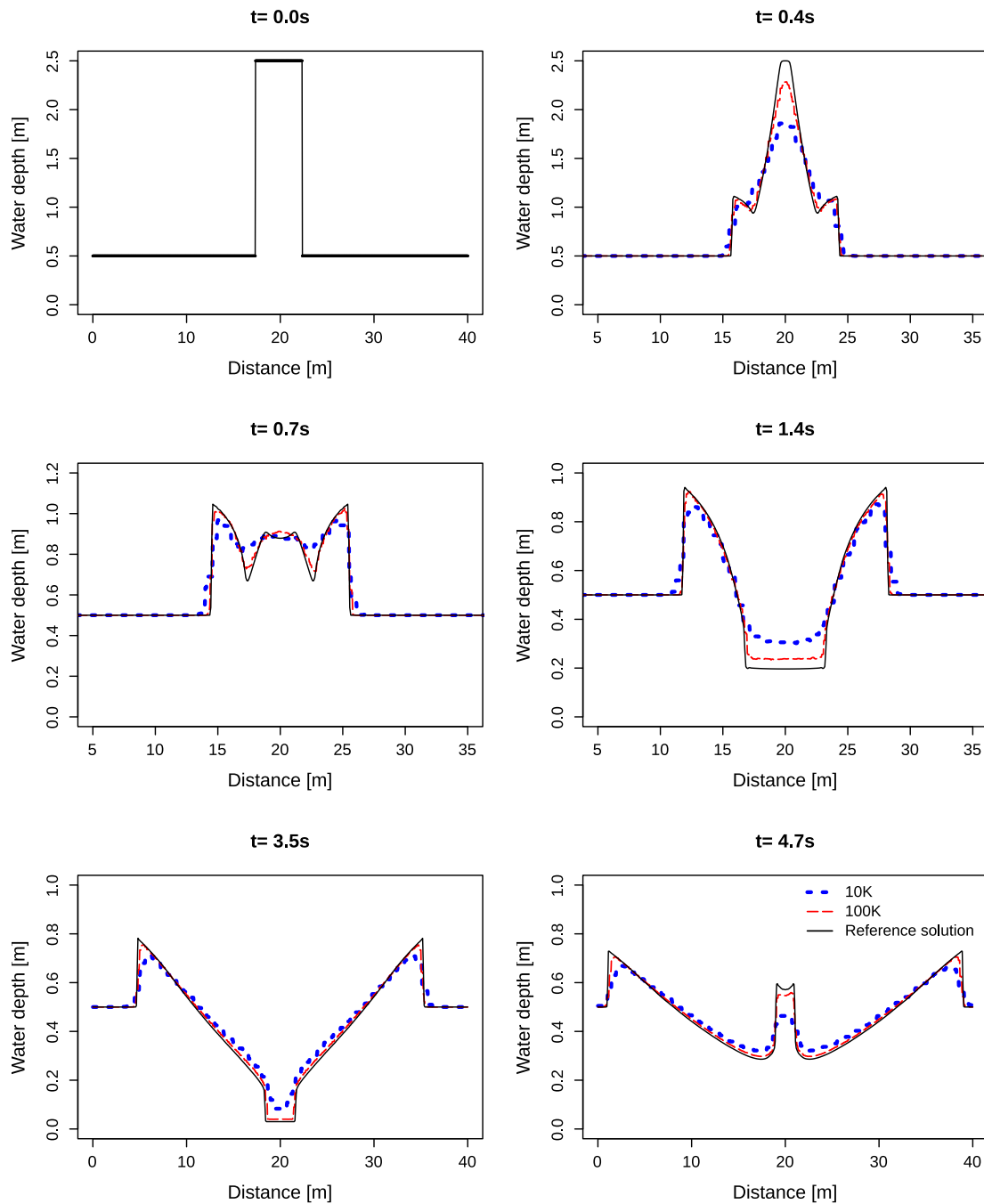

Figure 5.2 Snapshots of the water depth evolution along the reference cross-section. Comparison between BASEMENT simulations with a computational grid of 10k cells, 100k cells and the reference solution of Toro (2001).

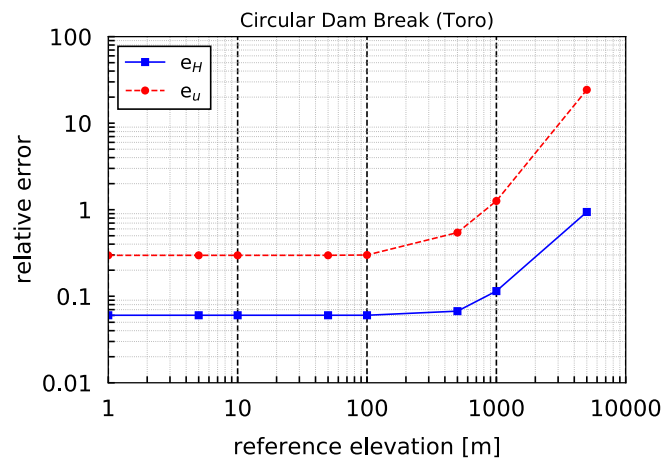

Figure 5.3 Relative error compared to the reference solution of Toro (2001)

5.2.4 Performance

The performance is evaluated in terms of effective computation time and in terms of speedup S . The latter is a measure of parallelization efficiency. The speedup S is calculated as the division of the sequential runtime T_1 (of each mesh size respectively) by the runtime with a certain number of cores T_N or a specific GPU card.

5.2.4.1 Ubuntu

Tables 5.4, 5.5 and 5.6 contain the execution time and speedup of all the simulations performed on different backends under Linux. The backends belong to two categories, either in Central Processor Units (CPU) or Graphics Processor Units (GPU). The CPU run simulations exclusively with double precision, while GPU can perform simulations with single or double precision. More details are explained in Section 5.1.2.

Table 5.3 Computational time (s) and speedup (in parentheses) of the circular dam break simulations for CPU simulations under Ubuntu 16.04 (Intel Xeon Gold 6154, 3.00GHz)

Mesh size	Xeon 1 Double	Xeon 2 Double	Xeon 4 Double	Xeon 8 Double	Xeon 16 Double	Xeon 32 Double
10k	0.16	0.19 (1.49x)	0.11 (2.46x)	0.07 (3.33x)	0.04 (4.18x)	0.03 (5.31x)
50k	1.88	1.08 (1.73x)	0.57 (3.29x)	0.33 (5.70x)	0.20 (9.31x)	0.15 (12.68x)
100k	5.44	3.06 (1.77x)	1.62 (3.35x)	0.89 (6.12x)	0.52 (10.4x)	0.35 (15.47x)
500k	63.63	34.49 (1.85x)	17.71 (3.59x)	9.28 (6.86x)	5.06 (12.57x)	3.07 (20.72x)
1000k	190.39	101.66 (1.87x)	51.83 (3.67x)	26.98 (7.06x)	14.36 (13.26x)	8.75 (21.77x)

Table 5.4 Computational time (s) and speedup (in parentheses) of the circular dam break simulations for CPU simulations under Ubuntu 16.04 (Intel Xeon E5-2667 v3 @ 3.20GHz)

Mesh size	Xeon 1 Double	Xeon 2 Double	Xeon 4 Double	Xeon 8 Double	Xeon 16 Double
10k	0.16	0.19 (1.49x)	0.11 (2.46x)	0.07 (3.33x)	0.04 (4.18x) 0.03 (5.31x)
50k	1.88	1.08 (1.73x)	0.57 (3.29x)	0.33 (5.70x)	0.20 (9.31x) 0.15 (12.68x)

Mesh size	Xeon 1 Double	Xeon 2 Double	Xeon 4 Double	Xeon 8 Double	Xeon 16 Double
100k	5.44	3.06 (1.77x)	1.62 (3.35x)	0.89 (6.12x)	0.52 0.35 (10.4x) (15.47x)
500k	63.63	34.49 (1.85x)	17.71 (3.59x)	9.28 (6.86x)	5.06 3.07 (12.57x) (20.72x)
1000k	190.39	101.66 (1.87x)	51.83 (3.67x)	26.98 (7.06x)	14.36 8.75 (13.26x) (21.77x)

Table 5.5 Computational time (s) and speedup (in parentheses) of the circular dam break simulations for GPU simulations

Mesh size	Xeon 1 Double	RTX 2080Ti Single	RTX 2080Ti Double	Tesla K20 Single	Tesla K20 Double	Tesla P100 Single	Tesla P100 Double
10k	0.16	0.04 (4.41x)	0.04 (4.10x)	0.06 (2.86x)	0.05 (2.99x)	0.04 (3.85x)	0.04 (4.04x)
50k	1.88	0.15 (12.18x)	0.19 (9.74x)	0.24 (7.90x)	0.27 (7.01x)	0.18 (10.5x)	0.18 (10.53x)
100k	5.44	0.30 (18.01x)	0.37 (14.65x)	0.51 (10.61x)	0.59 (9.23x)	0.36 (15.28x)	0.37 (14.67x)
500k	63.63	1.66 (38.37x)	2.57 (24.72x)	3.42 (18.61x)	4.67 (13.61x)	2.13 (29.84x)	2.52 (25.28x)
1000k	190.39	3.63 (52.48x)	6.45 (29.54x)	8.63 (22.05x)	12.45 (15.29x)	5.03 (37.87x)	6.28 (30.33x)

Table 5.6 Computational time (s) and speedup (in parentheses) of the circular dam break simulations for GPU simulations

Mesh size	Xeon 1 Double	GTX 1050Ti Single	GTX 1050Ti Double	GTX 1070Ti Single	GTX 1070Ti Double	GTX 1080Ti Single	GTX 1080Ti Double
10k	0.16	0.04 (3.98x)	0.05 (2.93x)	0.03 (4.42x)	0.04 (4.00x)	0.04 (4.26x)	0.04 (4.05x)
50k	1.88	0.20 (9.28x)	0.34 (5.53x)	0.13 (11.1x)	0.21 (8.78x)	0.16 (11.81x)	0.19 (9.68x)

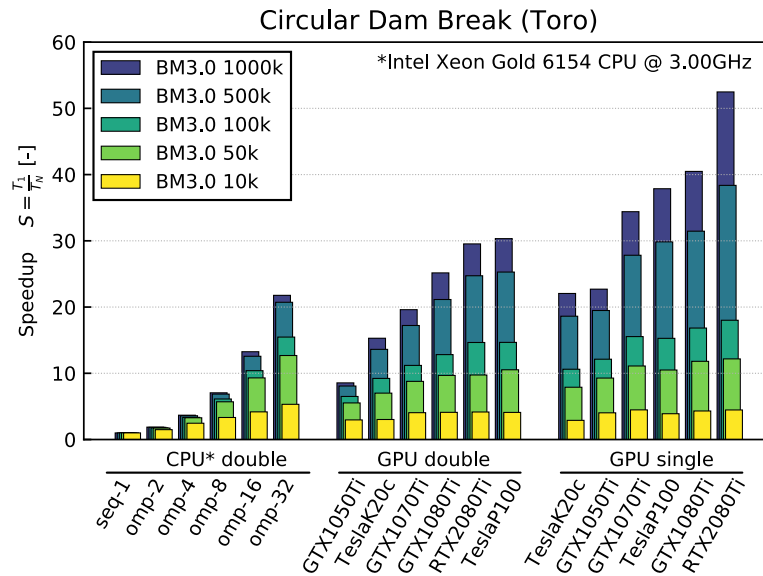

Figure 5.4 Speedup for CPU (double precision) and GPU (single and double precision) backends for the circular dam break test case.

Mesh size	Xeon 1 Double	GTX 1050Ti	GTX 1050Ti	GTX 1070Ti	GTX 1070Ti	GTX 1080Ti	GTX 1080Ti
		Single	Double	Single	Double	Single	Double
100k	5.44	0.45 (12.13x)	0.84 (6.5x)	0.30 (15.54x)	0.49 (11.19x)	0.21 (16.83x)	0.42 (12.82x)
500k	63.63	3.27 (19.48x)	7.88 (8.08x)	1.96 (27.82x)	3.70 (17.21x)	2.02 (31.45x)	3.01 (21.14x)
1000k	190.39	8.55 (22.70x)	22.26 (8.55x)	5.53 (34.40x)	9.71 (19.61x)	4.70 (40.48x)	7.57 (25.16x)

Figure 5.4 shows the speedup achieved by the different backends. The sequential and OpenMP backends were run on processors of type Intel Xeon Gold 6154 (3.00GHz) with two sockets and with 18 cores per socket. The largest speedups are obtained for certain GPU cards using single precision. But also by using the GPU backend with double precision, the simulation time can be reduced significantly compared to sequential computation. It should be noted that the results of simulations with single and double precision can vary greatly depending on the problem. Further, it can be observed that the speedup greatly depends on the problem size. For smaller mesh, the speedup obtained by increasing the number of cores or by using GPU cards can be limited. The speedup increases particularly for meshes with a fine resolution (500K and 1000K) using GPU.

Figure 5.5 compares the speedup with the number of threads (CPU) between the different mesh resolutions. The simulations were performed using the CPU backend with Intel Xeon

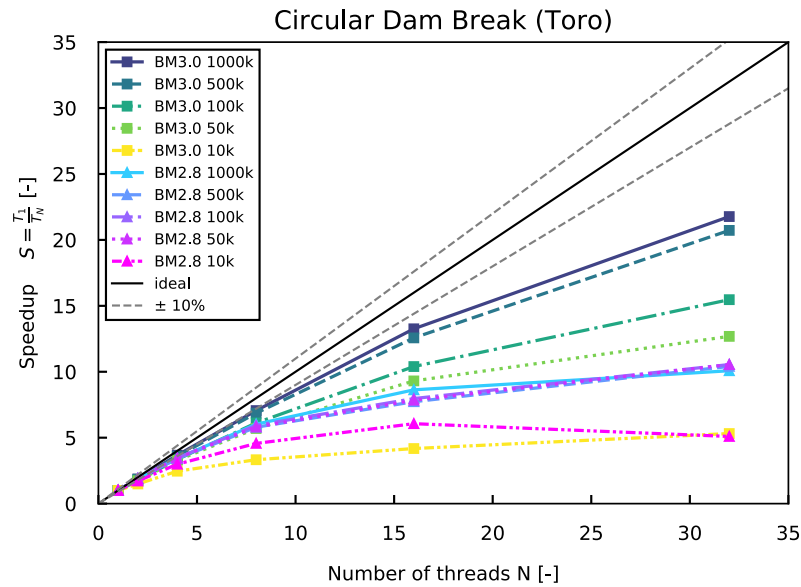

Figure 5.5 Speedup of the computational time $[T_N]$ using different number of threads (CPU) compared to the time of the sequential backend Xeon1 $[T_1]$ for the circular dam break

Gold 6154 (3.00GHz) processors. The speedup is more effective for meshes with a fine resolution than for those of coarse resolution, where the increase in number of cores leads to a plateau.

5.2.4.2 Windows

Tables 5.7 contains the execution time and speedup of all the simulations performed on different backends under Windows. The simulations were run on Prozessor Intel Xeon E-2174G (3.80GHz) processors with 4 cores and 2 threads per core (8 logical cores using HyperThreading). The performance scales adequately up to 4 cores. The use of 8 logical usings (HyperThreading) does not results in a significant improvement of performance compared to using 4 physical cores.

Table 5.7 Computational time (s) and speedup (in parentheses) of the circular dam break simulations for CPU simulations under Windows 10 (Intel Xeon E-2174G, 3.80GHz)

Mesh size	Xeon 1 Double	Xeon 2 Double	Xeon 4 Double	Xeon 8 Double
10k	0.23	0.14 (1.67x)	0.08 (3.0x)	0.09 (2.49x)
50k	2.80	1.58 (1.77x)	0.98 (2.84x)	0.81 (3.44x)
100k	8.08	4.73 (1.71x)	3.16 (2.56x)	2.58 (3.13x)

Mesh size	Xeon 1 Double	Xeon 2 Double	Xeon 4 Double	Xeon 8 Double
500k	95.01	51.78 (1.83x)	30.55 (3.11x)	23.62 (4.02x)
1000k	275.02	149.84 (1.84x)	90.00 (3.06x)	67.25 (4.09x)

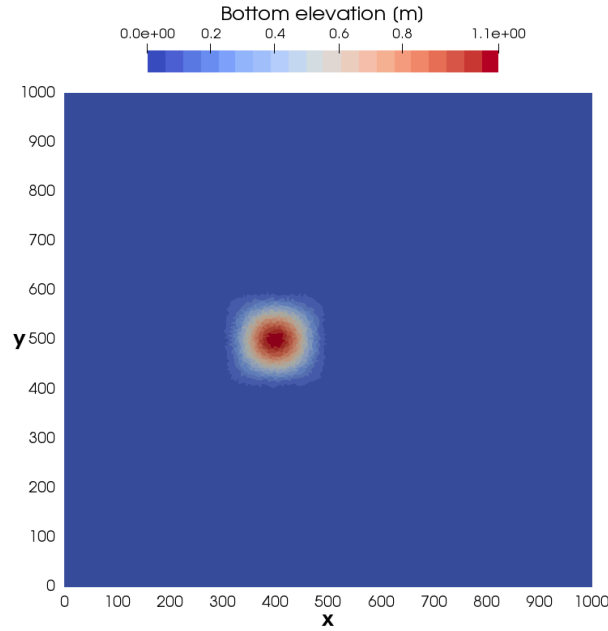

Figure 5.6 Initial bottom elevation of the conical dune, maximum elevation of 1.1 m at $[x=400, y=500]$.

5.3 Conical Dune

5.3.1 Description

The conical dune test proposed by Hudson and Sweby (2005) is used to assess the accuracy of two dimensional morphodynamic models under sub-critical flow and without friction. The simulation describes the evolution of an initial conical dune of sediments that evolves in a star shaped pattern characterized by a spread angle α_s . Numerical results are compared with the approximate analytical solution for the spread angle of the disturbance front proposed by de Vriend (1987).

5.3.2 Geometry and Initial Conditions

The computational mesh is a squared area of size 1000 x 1000 m with an initial bottom elevation $z_{B,initial}$ (see Figure 5.6):

$$z_{B,initial} = \begin{cases} 0.1 + \sin^2\left(\frac{\pi(x-300)}{200}\right) \sin^2\left(\frac{\pi(y-400)}{200}\right) & \text{for } x \in [300, 500] \\ & \text{and } y \in [400, 600] \\ 0.1 & \text{otherwise} \end{cases} \quad (5.3)$$

An inflow boundary condition of Froude type is defined along the y-axis at $x=0$ setting a constant unit discharge of 10 m/s. At $x=1000$ m, a h-Q relation is defined as outflow boundary condition. The initial water depth is 10 m and the water surface elevation is kept constant at the boundaries. The Strickler coefficient is set to $K_s = 10^7 [m^{1/3}/s]$ in order to obtain an almost frictionless simulation. The CFL number is set to 0.8, the

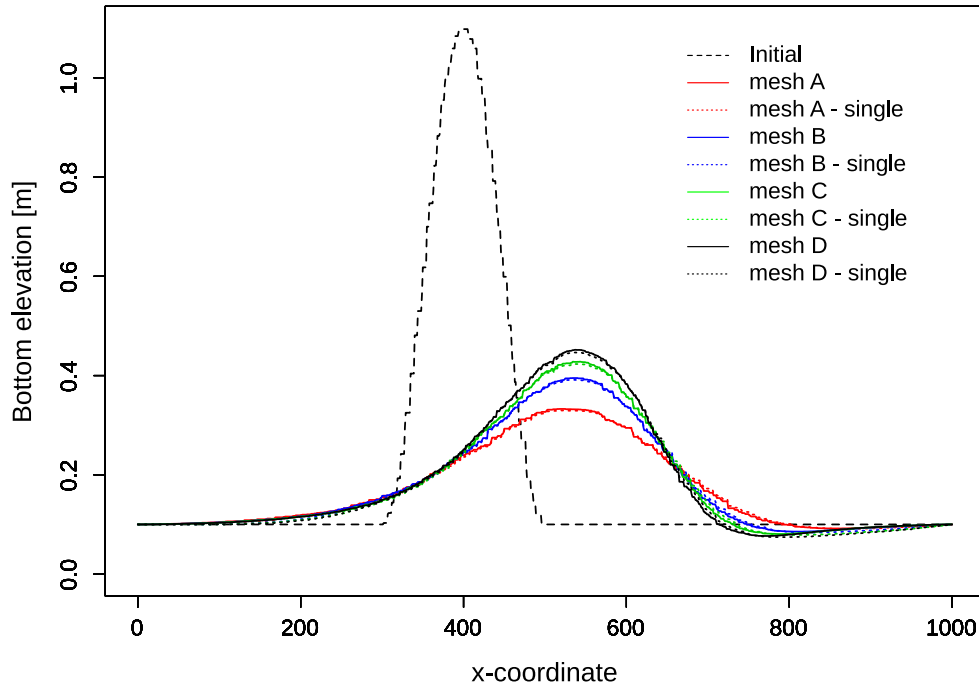

Figure 5.7 Longitudinal bottom elevation profile at $y=500$ m for initial conditions and after 100h of simulation for the meshes A, B, C and D with double and single precision

porosity to 0.4 and the morphodynamic boundary conditions are at equilibrium. Bed load transport is computed using the Grass formula with the parameters $A_G = 0.001002$ and $m_G = 3$ assuming a slow interaction between the sediment layer and the water flow. The analytical solution for the spread angle (eq. 5.4) proposed by de Vriend (1987) gives a value of $\alpha_{s,ref} = 21.787^\circ$.

$$\alpha_s = \arctan\left(\frac{3\sqrt{3}(m_G - 1)}{9m_G - 1}\right) \quad (5.4)$$

The tests were performed with different computational mesh resolution, mesh A has 30160 cells (30k), mesh B 61201 cells (60k), mesh C 91083 cells (90k) and mesh D 126020 cells (120k). The simulation results were analyzed after 100 hours and each test was performed using different backends.

5.3.3 Results

Figure 5.7 shows the bed elevation profile at $y = 500$ m along the x -coordinates at the beginning and after 100 h of the simulation for the four different meshes (A, B, C and D) performed with double and single precision. The results are exactly the same for all processor types, except for the simulation performed with CUDA-single, where the values are slightly different due to the reduced precision.

Table 5.8 summarizes the results obtained from the numerical simulations at $t=100$ h for

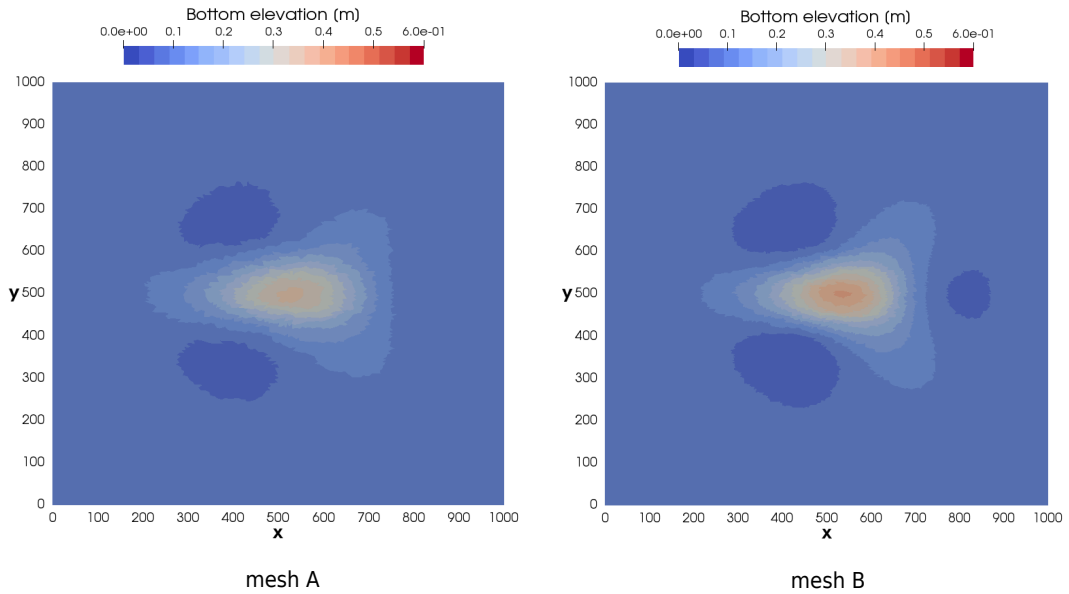

Figure 5.8 Planar view of the bottom elevation after 100 hours of simulation for the meshes A and B.

the different meshes using the backend types CPU and GPU-double. The spread angle α_s is measured between $y = 500$ m and the line passing through the initial conical dune center point and the farthest point in the x -direction where the conical dune spread for a similar bottom elevation (Figure 5.8 and Figure 5.9). The spread angle was measured at time $t=25$ h, 50h, 75h and 100h for each mesh size and the mean value is reported in Table 5.8. The accuracy of the simulations is assessed by the relative deviation between the measure spread angle α_s and the spread angle defined by de Vriend (1987) $\alpha_{s,ref}$.

Table 5.8 Summary of the simulation results performed with CPU and GPU double at $t=100$ h for different computational meshes

Mesh	Number of cells [-]	Max. cone elevation [m]	α_s [°]	Relative deviation [%]
A	30160	0.3327	25.57	16.0
B	61201	0.3950	25.12	14.2
C	91083	0.4279	23.94	9.4
D	126020	0.4518	23.35	6.9

The maximum bottom elevation after 100h increases with the mesh resolution while the spread angle decreases (Table 5.8). The results are more accurate for finer meshes (mesh C and mesh D, Figure 5.7), where less diffusive sediment transport is observed and thus the maximum bottom elevation after 100h is higher than for coarser meshes. This increase in accuracy for finer meshes is also observed in Figure 5.8 and Figure 5.9 by a well defined star shaped sediment transport and a spread angle that becomes closer to the value proposed by de Vriend (1987).

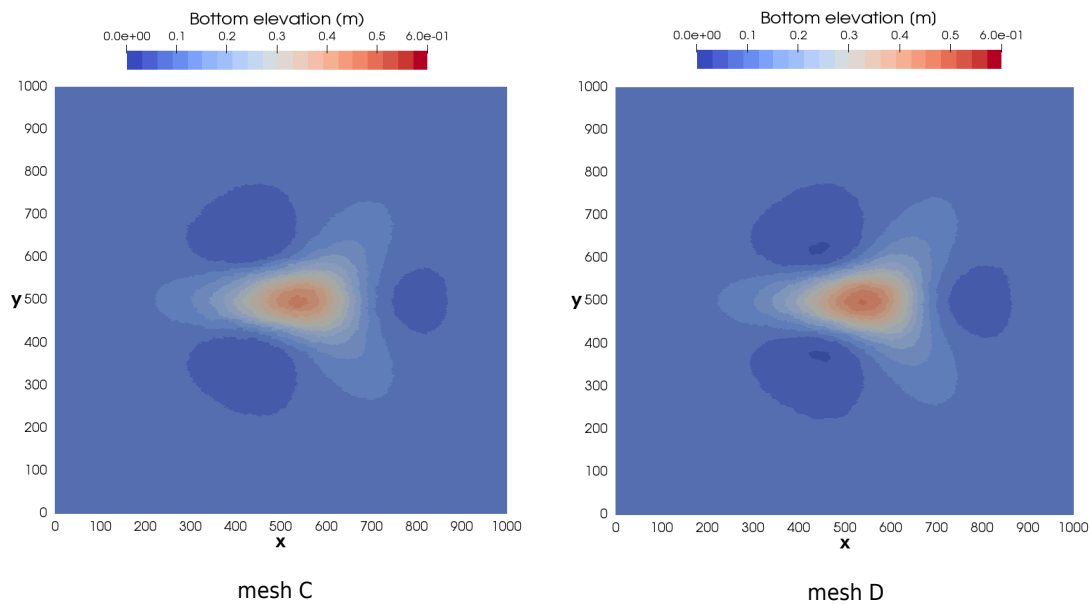

Figure 5.9 Planar view of the bottom elevation after 100 hours of simulation for the meshes C and D.

5.4 Dam-break flow in a L-shaped channel with a mobile-bed

5.4.1 Description

This test case is based on the experiments described in Palumbo et al. (2008) and is a frequently used benchmark test case in literature (e.g. Siviglia et al. (2013), Soares-Frazão and Zech (2011)).

5.4.2 Geometry and initial conditions

This test case consist of a domain with a non-symmetrical sudden enlargement. The dimensions of the domain as illustrated in Figure 5.10. The sediment bed is composed of coarse uniform sand with grain size diameter of $d_s = 1.82$ mm. The sediment porosity is $p = 0.47$ and the sediment density $\rho_s = 2680$ kg/m³. The Manning friction coefficient is set to $n = 0.0167$ s/m^{1/3}. The initial bed level is at an elevation of 0.1 m over the whole domain. The initial water depth upstream (left) of the dam is set to 0.25 m. The dam at is located at $x = 3.0$ m. At time $t = 0$ seconds, he dam is removed instantaneously, resulting in wave propagation and sediment transport.

The computational domain is discretised by unstructured triangular cells. Four different sized computational grids were generated, resulting in grids with 27,000 cells (27k), 54,000 cells (54k), 108,000 cells (108k), 216,000 cells (216k). Wall boundary conditions are applied at the domain side walls. At the outflow boundary (right), a free-outflow boundary condition was applied. The sediment transport is calculated using the MPM_like formula with a pre-factor of 3.97 and an exponent of 1.5. The simulation lasts 12 seconds.

5.4.3 Results

The simulated bed elevations at $t = 12$ s are compared to the experimental results from Palumbo et al. (2008) in Figure 5.11. Overall, the simulated bed elevations are in acceptable agreement with experimental data. The scour in cross section CS1 ($x = 4.1$ m) is matched well, while the deposition around $y = 0.3$ m is underestimated. At cross-section CS2, the numerical results correspond well with the experimental data. In particular at location CS1, the observed deviations may be attributed to distinct 3D flow effects that are not captured by the 2D depth-averaged model (Siviglia et al. 2013, Xia et al. 2010).

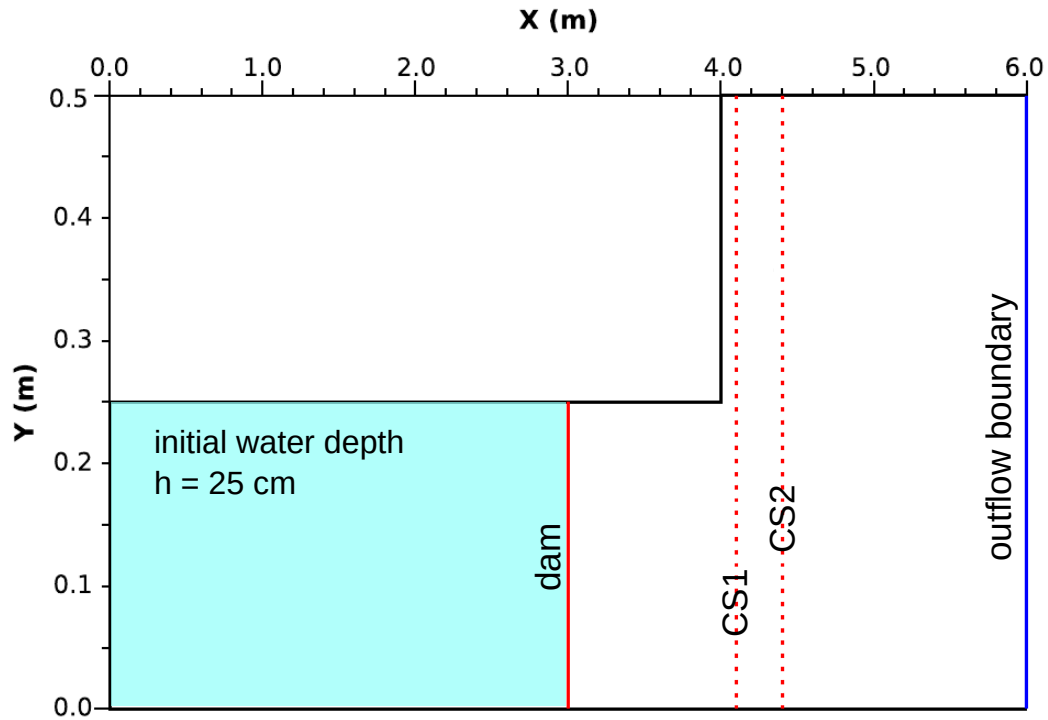

Figure 5.10 The numerical test setup for the dam-break flow in a L-shaped channel with a mobile-bed. Experimental and numerical bed elevations are compared along cross-sections CS1 and CS2. Modified from Siviglia et al. (2013).

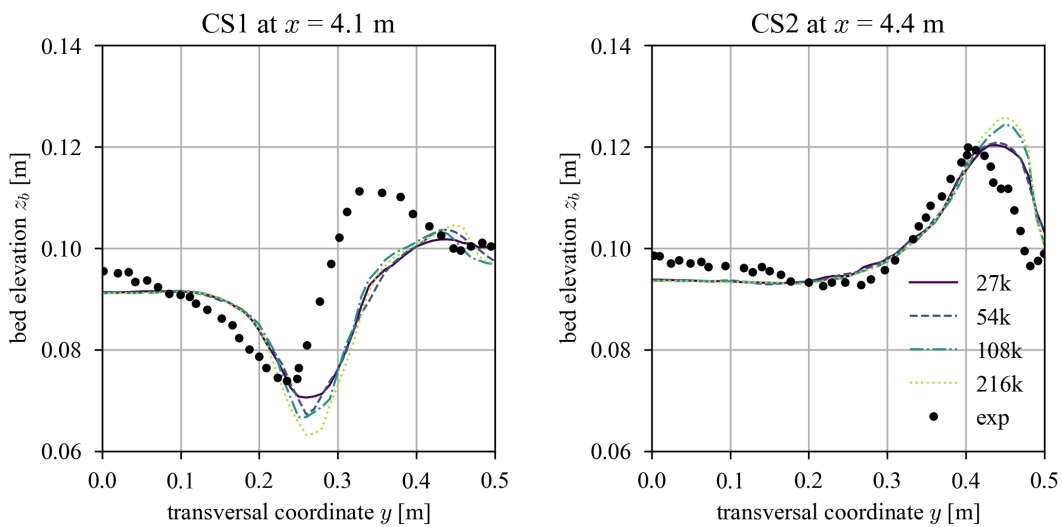

Figure 5.11 Experimental and numerical bed elevation are compared at cross-sections CS1 and CS2.

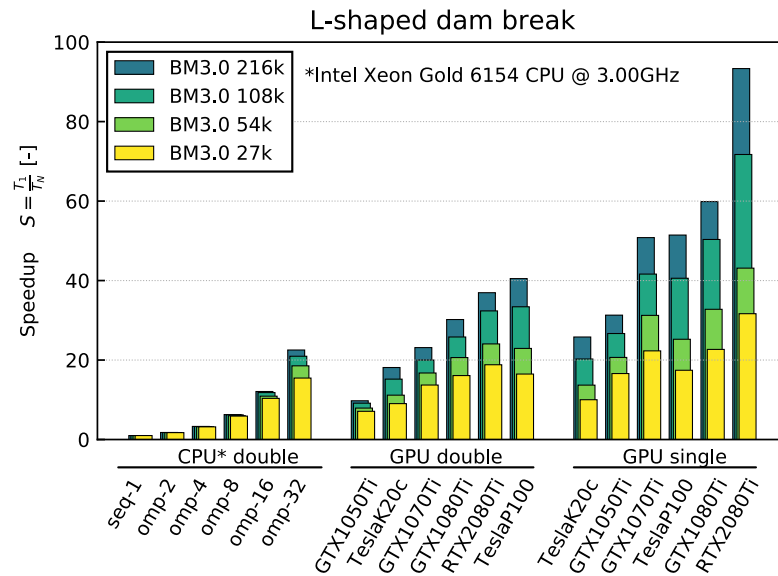

Figure 5.12 Speedup of the computational time $[T_N]$ for CPU (double) and GPU (single and double) compared to the time of the sequential backend Xeon1 $[T_1]$ for the L-shaped dam break test case.

5.4.4 Performance

5.4.4.1 Ubuntu

Simulations of this test case were performed on CPU- and GPU-backends. The largest execution times are obtained by using the sequential backend. By using the OpenMP-backend, the computation time can be reduced almost linearly with the number of cores. Also by using GPU-backends the computation time can be reduced in comparison to sequential computation, whereas the increase in performance depends on the GPU-card and the precision (single or double). The best performance using double precision is obtained with the card Tesla P100, while the RTX 2080Ti outperformed other cards when using single precision (see Tables 5.9, 5.10 and 5.11 or Figure 5.12). It should be noted that the results of simulations with single and double precision can vary greatly depending on the problem.

Table 5.9 Computational time (s) and speedup S (inside brackets) of the L-shaped dam break simulations for CPU simulations (Intel Xeon Gold 6154, 3.00GHz)

Mesh size	Xeon 1 Double	Xeon 2 Double	Xeon 4 Double	Xeon 8 Double	Xeon 16 Double	Xeon 32 Double
30k	43.8	25.2 (1.7x)	13.7 (3.2x)	7.4 (5.9x)	4.2 (10.4x)	2.8 (15.5x)
60k	97.7	56.1 (1.7x)	30.4 (3.2x)	16.3 (6.0x)	9.0 (10.9x)	5.3 (18.5x)

Mesh size	Xeon 1 Double	Xeon 2 Double	Xeon 4 Double	Xeon 8 Double	Xeon 16 Double	Xeon 32 Double
90k	357.3	202.7 (1.8x)	109.3 (3.3x)	57.5 (6.2x)	3.2 (11.8x)	17.0 (21.0x)
120k	1096.3	618.5 (1.8x)	332.6 (3.3x)	174.9 (6.3x)	90.7 (12.1x)	48.7 (22.5x)

Table 5.10 Computational time (s) and speedup S (inside brackets) of the L-shaped dam break simulations for GPU simulations

Mesh size	Xeon 1 Double	RTX 2080Ti Single	RTX 2080Ti Double	Tesla K20 Single	Tesla K20 Double	Tesla P100 Single	Tesla P100 Double
30k	43.8	1.4 (31.7x)	2.3 (18.8x)	4.4 (10.0x)	4.8 (9.0x)	2.5 (17.4x)	2.7 (16.5x)
60k	97.7	2.3 (43.1x)	4.1 (24.1)	7.1 (13.7x)	8.8 (11.2x)	3.9 (25.2x)	4.3 (22.9x)
90k	357.3	5.0 (71.7x)	11.0 (32.4x)	17.6 (20.3x)	23.5 (15.2x)	8.8 (40.6x)	10.7 (33.4x)
120k	1096.3	11.7 (93.3x)	29.7 (37.0x)	42.5 (25.8x)	60.5 (18.1x)	21.3 (51.4x)	27.1 (40.5x)

Table 5.11 Computational time (s) and speedup S (inside brackets) of the L-shaped dam break simulations for GPU simulations

Mesh size	Xeon 1 Double	GTX 1050 Single	GTX 1050 Double	GTX 1070 Single	GTX 1070 Double	GTX 1080 Single	GTX 1080 Double
30k	43.8	2.6 (16.6x)	6.2 (7.1x)	2.0 (22.3x)	3.2 (13.7x)	1.9 (22.7x)	2.7 (16.1x)
60k	97.7	4.7 (20.7x)	12.4 (7.9x)	3.1 (31.2x)	5.8 (16.7x)	3.0 (32.8x)	4.7 (20.69x)
90k	357.3	13.4 (26.7x)	39.1 (9.1x)	8.6 (41.6x)	17.9 (20.0x)	7.1 (50.3x)	13.8 (25.8x)
120k	1096.3	35.0 (31.3x)	112.4 (9.8x)	21.6 (50.8x)	47.4 (23.1x)	18.3 (59.9x)	36.3 (30.2x)

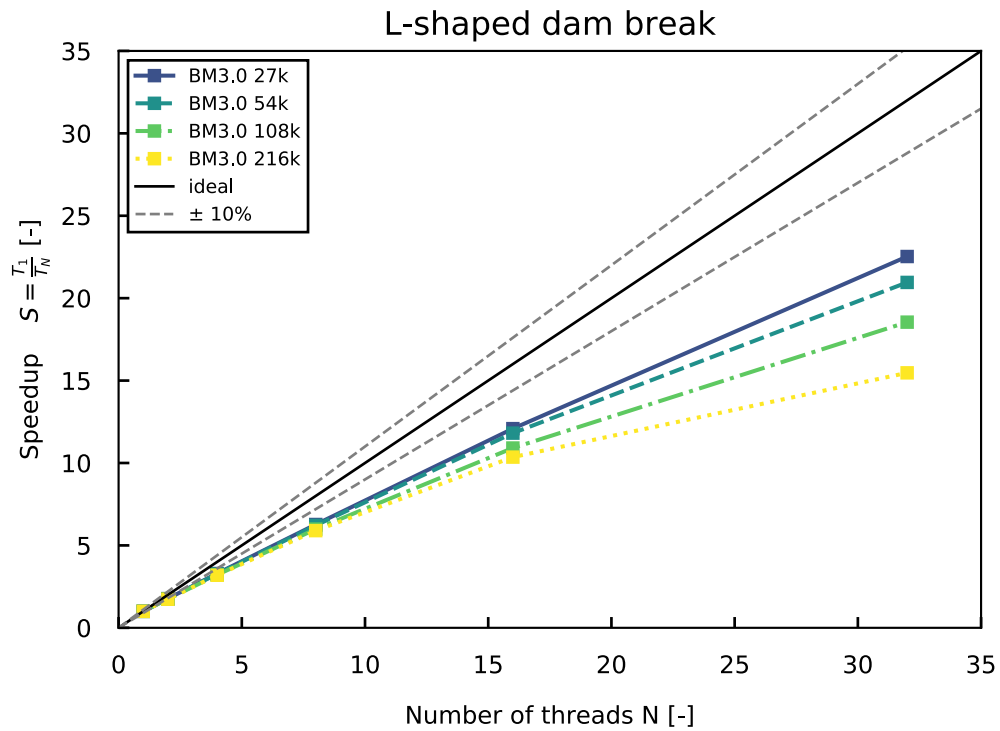

Figure 5.13 Speedup of the L-shaped dam break test case performed on CPU for an increasing number of threads and different mesh sizes

In Figure 5.13, the speedup of the OpenMP-backend is illustrated for different mesh sizes on an Intel Xeon Gold 6154 (3.00GHz) processor on an Ubuntu system with 36 cores. The speedup of scales almost linearly up to 32 cores for this test case, indicating a good scaling behaviour.

5.4.4.2 Windows

Tables 5.12 contains the execution time and speedup of the simulations performed on different backends under Windows. The simulations were run on Prozessor Intel Xeon E-2174G (3.80GHz) processors with 4 cores and 2 threads per core (8 logical cores using HyperThreading). The performance scales adequately up to 4 cores. The use of 8 logical usings (HyperThreading) does not results in a significant improvement of performance compared to using 4 physical cores.

Table 5.12 Computational time (s) and speedup (in parentheses) for CPU simulations of L-shaped dam break with a mobile bed under Windows 10 (Intel Xeon E-2174G, 3.80GHz)

Mesh size	Xeon 1 Double	Xeon 2 Double	Xeon 4 Double	Xeon 8 Double
27k	70.0	38.3 (1.83x)	25.6 (2.73x)	16.8 (4.18x)

Mesh size	Xeon 1 Double	Xeon 2 Double	Xeon 4 Double	Xeon 8 Double
54k	158.8	87.3 (1.82x)	58.1 (2.73x)	37.5 (4.23x)
108k	578.5	319.6 (1.81x)	212.3 (2.72x)	137.7 (4.20x)
216k	1770.6	986.0 (1.80x)	680.9 (2.60x)	427.8 (4.14x)

6

References

- de Vriend, H.J. (1987). 2DH mathematical modelling of morphological evolutions in shallow water. *Coastal engineering*, 11(1): 1–27.
- Ginzburg, I., Carlier, J.P. and Kao, C. (2004). Lattice Boltzmann approach to Richard's equation. *Proceedings of the CMWR XV, CT Miller*, 583–597. Chapel Hill, NC, USA.
- Hudson, J. and Sweby, P.K. (2005). A high-resolution scheme for the equations governing 2D bed-load sediment transport. *International Journal for Numerical Methods in Fluids*, 47: 1085–1091.
- Kassem, A.A. and Chaudhry, M.H. (1998). Comparison of Coupled and Semicoupled Numerical Models for Alluvial Channels. *Journal of Hydraulic Engineering-Asce*, 124(8): 794–802.
- Palumbo, A., Soares Frazao, S., Goutière, L., Pianese, D. and Zech, Y. (2008). Dam-break flow on mobile bed in a channel with a sudden enlargement. *Proceedings of the river flow 2008 conference*,.
- Pham Van, S. (2009). Application of Different Model Concepts for Simulation of Two-Phase Flow Processes in Porous Media with Fault Zones [PhD thesis]: Book Series of Institute of Civil Engineering, Volume 3, Technische Universität Berlin.
- Saiedi, S. (1981b). A non-dimensional coupled numerical model of alluvial flow. *International Journal of Sediment Research*, 9(2): 59–79.
- Saiedi, S. (1981a). Experience in design of a laboratory flume for sediment studies. *International Journal of Sediment Research*, 8(3): 89–101.
- Siviglia, A., Stecca, G., Vanzo, D., Zolezzi, G. and Toro, E.F. (2013). Numerical modelling of two-dimensional morphodynamics with applications to river bars and bifurcations. *Advances in Water Resources*, 52: 243–260.
- Soares-Frazão, S. and Zech, Y. (2011). HLLC scheme with novel wave-speed estimators appropriate for two-dimensional shallow-water flow on erodible bed. *International Journal for Numerical Methods in Fluids*, 66.
- Soni, J.P. (1981). Laboratory Study of Aggradation in Alluvial Channels. *Journal of Hydrology*, 49(1-2): 87–106.
- Soni, J.P., Garde, R.J. and Ranga Raju, K.G. (1980). Aggradation in Streams Due to Overloading. *Journal of the Hydraulics Division-Asce*, 106(1): 117–132.
- Soulis, J.V. (2002). A fully coupled numerical technique for 2-D bed morphology

- calculations. *International Journal for Numerical Methods in Fluids*, 38(1): 71–98.
- Toro, E.F. (2001). Shock-Capturing Methods for Free-Surface Shallow Flows. *John Wiley*, Chichester, New York.
- Tseng, M.-H. (1999). Verification of 1-D Transcritical Flow Model in Channels. *Natl. Sci. Counc. ROC(A)*, 23(5): 654–664.
- Valiani, A., Caleffi, V. and Zanni, A. (2002). Case Study: Malpasset Dam-Break Simulation using a Two-Dimensional Finite Volume Method. *Journal of Hydraulic Engineering*, 128(5): 460–472.
- Vanzo, D., Siviglia, A. and Toro, E.F. (2016). Pollutant transport by shallow water equations on unstructured meshes: Hyperbolization of the model and numerical solution via a novel flux splitting scheme. *Journal of Computational Physics*, 321: 1–20.
- Vasquez, J.A., Steffler, P.M. and Millar, R.G. (2005). River 2D Morphology, Part I: Straight Alluvial Channels. *17th canadian hydrotechnical conference*, Edmonton, Alberta.
- Vogel, T., van Genuchten, M.T. and Cislserova, M. (2001). Effect of the shape of the soil hydraulic functions near saturation on variably saturated flow predictions. *Advances in Water Resources*, 24: 133–144.
- Wiberg, P.L. and Smith, J.D. (1989). Model for Calculating Bed-Load Transport of Sediment. *Journal of Hydraulic Engineering-ASCE*, 115(1): 101–123.
- Yoon, T.H. and Kang, S.-K. (2004). Finite Volume Model for Two-Dimensional Shallow Water Flows on Unstructured Grids. *Journal of Hydraulic Engineering*, 130(7): 678–688.

**BASIC SIMULATION ENVIRONMENT
FOR MODELLING OF ENVIRONMENTAL
FLOWS AND NATURAL HAZARDS**

APPENDIX

**VERSION 4.0
FEBRUARY 2023**



BASEMENT

Third Party Software

1.1 Third party software licenses

Abseil

Apache License

Version 2.0, January 2004
<https://www.apache.org/licenses/>

TERMS AND CONDITIONS FOR USE, REPRODUCTION, AND DISTRIBUTION

1. Definitions.

"License" shall mean the terms and conditions for use, reproduction, and distribution as defined by Sections 1 through 9 of this document.

"Licensor" shall mean the copyright owner or entity authorized by the copyright owner that is granting the License.

"Legal Entity" shall mean the union of the acting entity and all other entities that control, are controlled by, or are under common control with that entity. For the purposes of this definition, "control" means (i) the power, direct or indirect, to cause the direction or management of such entity, whether by contract or otherwise, or (ii) ownership of fifty percent (50%) or more of the outstanding shares, or (iii) beneficial ownership of such entity.

"You" (or "Your") shall mean an individual or Legal Entity exercising permissions granted by this License.

"Source" form shall mean the preferred form for making modifications, including but not limited to software source code, documentation source, and configuration files.

"Object" form shall mean any form resulting from mechanical transformation or translation of a Source form, including but not limited to compiled object code, generated documentation, and conversions to other media types.

"Work" shall mean the work of authorship, whether in Source or Object form, made available under the License, as indicated by a copyright notice that is included in or attached to the work (an example is provided in the Appendix below).

"Derivative Works" shall mean any work, whether in Source or Object form, that is based on (or derived from) the Work and for which the editorial revisions, annotations, elaborations, or other modifications represent, as a whole, an original work of authorship. For the purposes of this License, Derivative Works shall not include works that remain separable from, or merely link (or bind by name) to the interfaces of, the Work and Derivative Works thereof.

"Contribution" shall mean any work of authorship, including the original version of the Work and any modifications or additions to that Work or Derivative Works thereof, that is intentionally submitted to Licensor for inclusion in the Work by the copyright owner or by an individual or Legal Entity authorized to submit on behalf of the copyright owner. For the purposes of this definition, "submitted" means any form of electronic, verbal, or written communication sent to the Licensor or its representatives, including but not limited to communication on electronic mailing lists, source code control systems, and issue tracking systems that are managed by, or on behalf of, the Licensor for the purpose of discussing and improving the Work, but excluding communication that is conspicuously marked or otherwise designated in writing by the copyright owner as "Not a Contribution."

"Contributor" shall mean Licensor and any individual or Legal Entity on behalf of whom a Contribution has been received by Licensor and subsequently incorporated within the Work.

2. Grant of Copyright License. Subject to the terms and conditions of this License, each Contributor hereby grants to You a perpetual, worldwide, non-exclusive, no-charge, royalty-free, irrevocable copyright license to reproduce, prepare Derivative Works of, publicly display, publicly perform, sublicense, and distribute the Work and such Derivative Works in Source or Object form.
3. Grant of Patent License. Subject to the terms and conditions of this License, each Contributor hereby grants to You a perpetual, worldwide, non-exclusive, no-charge, royalty-free, irrevocable (except as stated in this section) patent license to make, have made, use, offer to sell, sell, import, and otherwise transfer the Work, where such license applies only to those patent claims licensable by such Contributor that are necessarily infringed by their Contribution(s) alone or by combination of their Contribution(s) with the Work to which such Contribution(s) was submitted. If You institute patent litigation against any entity (including a cross-claim or counterclaim in a lawsuit) alleging that the Work or a Contribution incorporated within the Work constitutes direct or contributory patent infringement, then any patent licenses granted to You under this License for that Work shall terminate as of the date such litigation is filed.
4. Redistribution. You may reproduce and distribute copies of the Work or Derivative Works thereof in any medium, with or without modifications, and in Source or Object form, provided that You meet the following conditions:
 - (a) You must give any other recipients of the Work or Derivative Works a copy of this License; and
 - (b) You must cause any modified files to carry prominent notices stating that You changed the files; and
 - (c) You must retain, in the Source form of any Derivative Works that You distribute, all copyright, patent, trademark, and attribution notices from the Source form of the Work, excluding those notices that do not pertain to any part of the Derivative Works; and
 - (d) If the Work includes a "NOTICE" text file as part of its distribution, then any Derivative Works that You distribute must include a readable copy of the attribution notices contained

within such NOTICE file, excluding those notices that do not pertain to any part of the Derivative Works, in at least one of the following places: within a NOTICE text file distributed as part of the Derivative Works; within the Source form or documentation, if provided along with the Derivative Works; or, within a display generated by the Derivative Works, if and wherever such third-party notices normally appear. The contents of the NOTICE file are for informational purposes only and do not modify the License. You may add Your own attribution notices within Derivative Works that You distribute, alongside or as an addendum to the NOTICE text from the Work, provided that such additional attribution notices cannot be construed as modifying the License.

You may add Your own copyright statement to Your modifications and may provide additional or different license terms and conditions for use, reproduction, or distribution of Your modifications, or for any such Derivative Works as a whole, provided Your use, reproduction, and distribution of the Work otherwise complies with the conditions stated in this License.

5. **Submission of Contributions.** Unless You explicitly state otherwise, any Contribution intentionally submitted for inclusion in the Work by You to the Licensor shall be under the terms and conditions of this License, without any additional terms or conditions. Notwithstanding the above, nothing herein shall supersede or modify the terms of any separate license agreement you may have executed with Licensor regarding such Contributions.
6. **Trademarks.** This License does not grant permission to use the trade names, trademarks, service marks, or product names of the Licensor, except as required for reasonable and customary use in describing the origin of the Work and reproducing the content of the NOTICE file.
7. **Disclaimer of Warranty.** Unless required by applicable law or agreed to in writing, Licensor provides the Work (and each Contributor provides its Contributions) on an "AS IS" BASIS, WITHOUT WARRANTIES OR CONDITIONS OF ANY KIND, either express or implied, including, without limitation, any warranties or conditions of TITLE, NON-INFRINGEMENT, MERCHANTABILITY, or FITNESS FOR A PARTICULAR PURPOSE. You are solely responsible for determining the appropriateness of using or redistributing the Work and assume any risks associated with Your exercise of permissions under this License.
8. **Limitation of Liability.** In no event and under no legal theory, whether in tort (including negligence), contract, or otherwise, unless required by applicable law (such as deliberate and grossly negligent acts) or agreed to in writing, shall any Contributor be liable to You for damages, including any direct, indirect, special, incidental, or consequential damages of any character arising as a result of this License or out of the use or inability to use the Work (including but not limited to damages for loss of goodwill, work stoppage, computer failure or malfunction, or any and all other commercial damages or losses), even if such Contributor has been advised of the possibility of such damages.
9. **Accepting Warranty or Additional Liability.** While redistributing the Work or Derivative Works thereof, You may choose to offer, and charge a fee for, acceptance of support, warranty, indemnity, or other liability obligations and/or rights consistent with this License. However, in accepting such obligations, You may act only on Your own behalf and on Your sole responsibility, not on behalf of any other Contributor, and only if You agree to indemnify, defend, and hold each Contributor harmless for any liability incurred by, or claims asserted against, such Contributor by reason of your accepting any such warranty or additional liability.

END OF TERMS AND CONDITIONS

APPENDIX: How to apply the Apache License to your work.

To apply the Apache License to your work, attach the following boilerplate notice, with the fields enclosed by brackets "[]" replaced with your own identifying information. (Don't include the brackets!) The text should be enclosed in the appropriate comment syntax for the file format. We also recommend that a file or class name and description of purpose be included on the same "printed page" as the copyright notice for easier identification within third-party archives.

Copyright [yyyy] [name of copyright owner]

Licensed under the Apache License, Version 2.0 (the "License");
you may not use this file except in compliance with the License.
You may obtain a copy of the License at

<https://www.apache.org/licenses/LICENSE-2.0>

Unless required by applicable law or agreed to in writing, software distributed under the License is distributed on an "AS IS" BASIS, WITHOUT WARRANTIES OR CONDITIONS OF ANY KIND, either express or implied. See the License for the specific language governing permissions and limitations under the License.

Brotli

Copyright (c) 2009, 2010, 2013-2016 by the Brotli Authors.

Permission is hereby granted, free of charge, to any person obtaining a copy of this software and associated documentation files (the "Software"), to deal in the Software without restriction, including without limitation the rights to use, copy, modify, merge, publish, distribute, sublicense, and/or sell copies of the Software, and to permit persons to whom the Software is furnished to do so, subject to the following conditions:

The above copyright notice and this permission notice shall be included in all copies or substantial portions of the Software.

THE SOFTWARE IS PROVIDED "AS IS", WITHOUT WARRANTY OF ANY KIND, EXPRESS OR IMPLIED, INCLUDING BUT NOT LIMITED TO THE WARRANTIES OF MERCHANTABILITY, FITNESS FOR A PARTICULAR PURPOSE AND NONINFRINGEMENT. IN NO EVENT SHALL THE AUTHORS OR COPYRIGHT HOLDERS BE LIABLE FOR ANY CLAIM, DAMAGES OR OTHER LIABILITY, WHETHER IN AN ACTION OF CONTRACT, TORT OR OTHERWISE, ARISING FROM, OUT OF OR IN CONNECTION WITH THE SOFTWARE OR THE USE OR OTHER DEALINGS IN THE SOFTWARE.

Bzip2

This program, "bzip2", the associated library "libbzip2", and all documentation, are copyright (C) 1996-2019 Julian R Seward. All rights reserved.

Redistribution and use in source and binary forms, with or without modification, are permitted provided that the following conditions are met:

1. Redistributions of source code must retain the above copyright notice, this list of conditions and the following disclaimer.
2. The origin of this software must not be misrepresented; you must not claim that you wrote the original software. If you use this software in a product, an acknowledgment in the product documentation would be appreciated but is not required.
3. Altered source versions must be plainly marked as such, and must

not be misrepresented as being the original software.

4. The name of the author may not be used to endorse or promote products derived from this software without specific prior written permission.

THIS SOFTWARE IS PROVIDED BY THE AUTHOR ``AS IS'' AND ANY EXPRESS OR IMPLIED WARRANTIES, INCLUDING, BUT NOT LIMITED TO, THE IMPLIED WARRANTIES OF MERCHANTABILITY AND FITNESS FOR A PARTICULAR PURPOSE ARE DISCLAIMED. IN NO EVENT SHALL THE AUTHOR BE LIABLE FOR ANY DIRECT, INDIRECT, INCIDENTAL, SPECIAL, EXEMPLARY, OR CONSEQUENTIAL DAMAGES (INCLUDING, BUT NOT LIMITED TO, PROCUREMENT OF SUBSTITUTE GOODS OR SERVICES; LOSS OF USE, DATA, OR PROFITS; OR BUSINESS INTERRUPTION) HOWEVER CAUSED AND ON ANY THEORY OF LIABILITY, WHETHER IN CONTRACT, STRICT LIABILITY, OR TORT (INCLUDING NEGLIGENCE OR OTHERWISE) ARISING IN ANY WAY OUT OF THE USE OF THIS SOFTWARE, EVEN IF ADVISED OF THE POSSIBILITY OF SUCH DAMAGE.

Julian Seward, jseward@acm.org
bzip2/libbzip2 version 1.0.8 of 13 July 2019

Curl

COPYRIGHT AND PERMISSION NOTICE

Copyright (c) 1996 - 2022, Daniel Stenberg, <daniel@haxx.se>, and many contributors, see the THANKS file.

All rights reserved.

Permission to use, copy, modify, and distribute this software for any purpose with or without fee is hereby granted, provided that the above copyright notice and this permission notice appear in all copies.

THE SOFTWARE IS PROVIDED "AS IS", WITHOUT WARRANTY OF ANY KIND, EXPRESS OR IMPLIED, INCLUDING BUT NOT LIMITED TO THE WARRANTIES OF MERCHANTABILITY, FITNESS FOR A PARTICULAR PURPOSE AND NONINFRINGEMENT OF THIRD PARTY RIGHTS. IN NO EVENT SHALL THE AUTHORS OR COPYRIGHT HOLDERS BE LIABLE FOR ANY CLAIM, DAMAGES OR OTHER LIABILITY, WHETHER IN AN ACTION OF CONTRACT, TORT OR OTHERWISE, ARISING FROM, OUT OF OR IN CONNECTION WITH THE SOFTWARE OR THE USE OR OTHER DEALINGS IN THE SOFTWARE.

Except as contained in this notice, the name of a copyright holder shall not be used in advertising or otherwise to promote the sale, use or other dealings in this Software without prior written authorization of the copyright holder.

Double-conversion

Copyright 2006-2011, the V8 project authors. All rights reserved. Redistribution and use in source and binary forms, with or without modification, are permitted provided that the following conditions are met:

- * Redistributions of source code must retain the above copyright notice, this list of conditions and the following disclaimer.
- * Redistributions in binary form must reproduce the above copyright notice, this list of conditions and the following disclaimer in the documentation and/or other materials provided with the distribution.
- * Neither the name of Google Inc. nor the names of its contributors may be used to endorse or promote products derived from this software without specific prior written permission.

THIS SOFTWARE IS PROVIDED BY THE COPYRIGHT HOLDERS AND CONTRIBUTORS "AS IS" AND ANY EXPRESS OR IMPLIED WARRANTIES, INCLUDING, BUT NOT

LIMITED TO, THE IMPLIED WARRANTIES OF MERCHANTABILITY AND FITNESS FOR A PARTICULAR PURPOSE ARE DISCLAIMED. IN NO EVENT SHALL THE COPYRIGHT OWNER OR CONTRIBUTORS BE LIABLE FOR ANY DIRECT, INDIRECT, INCIDENTAL, SPECIAL, EXEMPLARY, OR CONSEQUENTIAL DAMAGES (INCLUDING, BUT NOT LIMITED TO, PROCUREMENT OF SUBSTITUTE GOODS OR SERVICES; LOSS OF USE, DATA, OR PROFITS; OR BUSINESS INTERRUPTION) HOWEVER CAUSED AND ON ANY THEORY OF LIABILITY, WHETHER IN CONTRACT, STRICT LIABILITY, OR TORT (INCLUDING NEGLIGENCE OR OTHERWISE) ARISING IN ANY WAY OUT OF THE USE OF THIS SOFTWARE, EVEN IF ADVISED OF THE POSSIBILITY OF SUCH DAMAGE.

Egl-registry

Copyright (c) 2008-2018 The Khronos Group Inc.

Permission is hereby granted, free of charge, to any person obtaining a copy of this software and/or associated documentation files (the "Materials"), to deal in the Materials without restriction, including without limitation the rights to use, copy, modify, merge, publish, distribute, sublicense, and/or sell copies of the Materials, and to permit persons to whom the Materials are furnished to do so, subject to the following conditions:

The above copyright notice and this permission notice shall be included in all copies or substantial portions of the Materials.

THE MATERIALS ARE PROVIDED "AS IS", WITHOUT WARRANTY OF ANY KIND, EXPRESS OR IMPLIED, INCLUDING BUT NOT LIMITED TO THE WARRANTIES OF MERCHANTABILITY, FITNESS FOR A PARTICULAR PURPOSE AND NONINFRINGEMENT. IN NO EVENT SHALL THE AUTHORS OR COPYRIGHT HOLDERS BE LIABLE FOR ANY CLAIM, DAMAGES OR OTHER LIABILITY, WHETHER IN AN ACTION OF CONTRACT, TORT OR OTHERWISE, ARISING FROM, OUT OF OR IN CONNECTION WITH THE MATERIALS OR THE USE OR OTHER DEALINGS IN THE MATERIALS.

Copyright 2013-2020 The Khronos Group Inc.
Copyright 2007-2020 The Khronos Group Inc.

SPDX-License-Identifier: Apache-2.0

Eigen3

Eigen is primarily MPL2 licensed. See COPYING.MPL2 and these links:
<http://www.mozilla.org/MPL/2.0/>
<http://www.mozilla.org/MPL/2.0/FAQ.html>

Some files contain third-party code under BSD or LGPL licenses, whence the other COPYING.* files here.

All the LGPL code is either LGPL 2.1-only, or LGPL 2.1-or-later.
For this reason, the COPYING.LGPL file contains the LGPL 2.1 text.

If you want to guarantee that the Eigen code that you are #including is licensed under the MPL2 and possibly more permissive licenses (like BSD), #define this preprocessor symbol:

```
EIGEN_MPL2_ONLY
```

For example, with most compilers, you could add this to your project CXXFLAGS:
-DEIGEN_MPL2_ONLY

This will cause a compilation error to be generated if you #include any code that is LGPL licensed.

Copyright (c) 2011, Intel Corporation. All rights reserved.

Redistribution and use in source and binary forms, with or without modification, are permitted provided that the following conditions are met:

- * Redistributions of source code must retain the above copyright notice, this list of conditions and the following disclaimer.
- * Redistributions in binary form must reproduce the above copyright notice, this list of conditions and the following disclaimer in the documentation and/or other materials provided with the distribution.
- * Neither the name of Intel Corporation nor the names of its contributors may be used to endorse or promote products derived from this software without specific prior written permission.

THIS SOFTWARE IS PROVIDED BY THE COPYRIGHT HOLDERS AND CONTRIBUTORS "AS IS" AND ANY EXPRESS OR IMPLIED WARRANTIES, INCLUDING, BUT NOT LIMITED TO, THE IMPLIED WARRANTIES OF MERCHANTABILITY AND FITNESS FOR A PARTICULAR PURPOSE ARE DISCLAIMED. IN NO EVENT SHALL THE COPYRIGHT OWNER OR CONTRIBUTORS BE LIABLE FOR ANY DIRECT, INDIRECT, INCIDENTAL, SPECIAL, EXEMPLARY, OR CONSEQUENTIAL DAMAGES (INCLUDING, BUT NOT LIMITED TO, PROCUREMENT OF SUBSTITUTE GOODS OR SERVICES; LOSS OF USE, DATA, OR PROFITS; OR BUSINESS INTERRUPTION) HOWEVER CAUSED AND ON ANY THEORY OF LIABILITY, WHETHER IN CONTRACT, STRICT LIABILITY, OR TORT (INCLUDING NEGLIGENCE OR OTHERWISE) ARISING IN ANY WAY OUT OF THE USE OF THIS SOFTWARE, EVEN IF ADVISED OF THE POSSIBILITY OF SUCH DAMAGE.

Minpack Copyright Notice (1999) University of Chicago. All rights reserved

Redistribution and use in source and binary forms, with or without modification, are permitted provided that the following conditions are met:

1. Redistributions of source code must retain the above copyright notice, this list of conditions and the following disclaimer.
2. Redistributions in binary form must reproduce the above copyright notice, this list of conditions and the following disclaimer in the documentation and/or other materials provided with the distribution.
3. The end-user documentation included with the redistribution, if any, must include the following acknowledgment:

"This product includes software developed by the University of Chicago, as Operator of Argonne National Laboratory.

Alternately, this acknowledgment may appear in the software itself, if and wherever such third-party acknowledgments normally appear.

4. WARRANTY DISCLAIMER. THE SOFTWARE IS SUPPLIED "AS IS" WITHOUT WARRANTY OF ANY KIND. THE COPYRIGHT HOLDER, THE UNITED STATES, THE UNITED STATES DEPARTMENT OF ENERGY, AND THEIR EMPLOYEES: (1) DISCLAIM ANY WARRANTIES, EXPRESS OR IMPLIED, INCLUDING BUT NOT LIMITED TO ANY IMPLIED WARRANTIES OF MERCHANTABILITY, FITNESS FOR A PARTICULAR PURPOSE, TITLE OR NON-INFRINGEMENT, (2) DO NOT ASSUME ANY LEGAL LIABILITY OR RESPONSIBILITY FOR THE ACCURACY, COMPLETENESS, OR USEFULNESS OF THE SOFTWARE, (3) DO NOT REPRESENT THAT USE OF THE SOFTWARE WOULD NOT INFRINGE PRIVATELY OWNED RIGHTS, (4) DO NOT WARRANT THAT THE SOFTWARE WILL FUNCTION UNINTERRUPTED, THAT IT IS ERROR-FREE OR THAT ANY ERRORS WILL BE CORRECTED.

5. LIMITATION OF LIABILITY. IN NO EVENT WILL THE COPYRIGHT HOLDER, THE UNITED STATES, THE UNITED STATES DEPARTMENT OF ENERGY, OR THEIR EMPLOYEES: BE LIABLE FOR ANY INDIRECT, INCIDENTAL, CONSEQUENTIAL, SPECIAL OR PUNITIVE DAMAGES OF ANY KIND OR NATURE, INCLUDING BUT NOT LIMITED TO LOSS OF PROFITS OR LOSS OF DATA, FOR ANY REASON WHATSOEVER, WHETHER

SUCH LIABILITY IS ASSERTED ON THE BASIS OF CONTRACT, TORT (INCLUDING NEGLIGENCE OR STRICT LIABILITY), OR OTHERWISE, EVEN IF ANY OF SAID PARTIES HAS BEEN WARNED OF THE POSSIBILITY OF SUCH LOSS OR DAMAGES.

Expat

Copyright (c) 1998-2000 Thai Open Source Software Center Ltd and Clark Cooper
Copyright (c) 2001-2019 Expat maintainers

Permission is hereby granted, free of charge, to any person obtaining a copy of this software and associated documentation files (the "Software"), to deal in the Software without restriction, including without limitation the rights to use, copy, modify, merge, publish, distribute, sublicense, and/or sell copies of the Software, and to permit persons to whom the Software is furnished to do so, subject to the following conditions:

The above copyright notice and this permission notice shall be included in all copies or substantial portions of the Software.

THE SOFTWARE IS PROVIDED "AS IS", WITHOUT WARRANTY OF ANY KIND, EXPRESS OR IMPLIED, INCLUDING BUT NOT LIMITED TO THE WARRANTIES OF MERCHANTABILITY, FITNESS FOR A PARTICULAR PURPOSE AND NONINFRINGEMENT. IN NO EVENT SHALL THE AUTHORS OR COPYRIGHT HOLDERS BE LIABLE FOR ANY CLAIM, DAMAGES OR OTHER LIABILITY, WHETHER IN AN ACTION OF CONTRACT, TORT OR OTHERWISE, ARISING FROM, OUT OF OR IN CONNECTION WITH THE SOFTWARE OR THE USE OR OTHER DEALINGS IN THE SOFTWARE.

Freetype

FREETYPE LICENSES

The FreeType 2 font engine is copyrighted work and cannot be used legally without a software license. In order to make this project usable to a vast majority of developers, we distribute it under two mutually exclusive open-source licenses.

This means that *you* must choose *one* of the two licenses described below, then obey all its terms and conditions when using FreeType 2 in any of your projects or products.

- The FreeType License, found in the file ``docs/FTL.TXT``, which is similar to the original BSD license *with* an advertising clause that forces you to explicitly cite the FreeType project in your product's documentation. All details are in the license file. This license is suited to products which don't use the GNU General Public License.

Note that this license is compatible to the GNU General Public License version 3, but not version 2.

- The GNU General Public License version 2, found in ``docs/GPLv2.TXT`` (any later version can be used also), for programs which already use the GPL. Note that the FTL is incompatible with GPLv2 due to its advertisement clause.

The contributed BDF and PCF drivers come with a license similar to that of the X Window System. It is compatible to the above two licenses (see files ``src/bdf/README`` and ``src/pcf/README``). The same holds for the source code files ``src/base/fthash.c`` and ``include/freetype/internal/fthash.h``; they were part of the BDF driver in earlier FreeType versions.

The gzip module uses the zlib license (see ``src/gzip/zlib.h``) which too is compatible to the above two licenses.

The MD5 checksum support (only used for debugging in development builds) is in the public domain.

--- end of LICENSE.TXT ---

Glew

The OpenGL Extension Wrangler Library
 Copyright (C) 2002-2007, Milan Ikits <milan ikits[at]ieee org>
 Copyright (C) 2002-2007, Marcelo E. Magallon <mmagallo[at]debian org>
 Copyright (C) 2002, Lev Povalahev
 All rights reserved.

Redistribution and use in source and binary forms, with or without modification, are permitted provided that the following conditions are met:

- * Redistributions of source code must retain the above copyright notice, this list of conditions and the following disclaimer.
- * Redistributions in binary form must reproduce the above copyright notice, this list of conditions and the following disclaimer in the documentation and/or other materials provided with the distribution.
- * The name of the author may be used to endorse or promote products derived from this software without specific prior written permission.

THIS SOFTWARE IS PROVIDED BY THE COPYRIGHT HOLDERS AND CONTRIBUTORS "AS IS" AND ANY EXPRESS OR IMPLIED WARRANTIES, INCLUDING, BUT NOT LIMITED TO, THE IMPLIED WARRANTIES OF MERCHANTABILITY AND FITNESS FOR A PARTICULAR PURPOSE ARE DISCLAIMED. IN NO EVENT SHALL THE COPYRIGHT OWNER OR CONTRIBUTORS BE LIABLE FOR ANY DIRECT, INDIRECT, INCIDENTAL, SPECIAL, EXEMPLARY, OR CONSEQUENTIAL DAMAGES (INCLUDING, BUT NOT LIMITED TO, PROCUREMENT OF SUBSTITUTE GOODS OR SERVICES; LOSS OF USE, DATA, OR PROFITS; OR BUSINESS INTERRUPTION) HOWEVER CAUSED AND ON ANY THEORY OF LIABILITY, WHETHER IN CONTRACT, STRICT LIABILITY, OR TORT (INCLUDING NEGLIGENCE OR OTHERWISE) ARISING IN ANY WAY OUT OF THE USE OF THIS SOFTWARE, EVEN IF ADVISED OF THE POSSIBILITY OF SUCH DAMAGE.

Mesa 3-D graphics library
 Version: 7.0

Copyright (C) 1999-2007 Brian Paul All Rights Reserved.

Permission is hereby granted, free of charge, to any person obtaining a copy of this software and associated documentation files (the "Software"), to deal in the Software without restriction, including without limitation the rights to use, copy, modify, merge, publish, distribute, sublicense, and/or sell copies of the Software, and to permit persons to whom the Software is furnished to do so, subject to the following conditions:

The above copyright notice and this permission notice shall be included in all copies or substantial portions of the Software.

THE SOFTWARE IS PROVIDED "AS IS", WITHOUT WARRANTY OF ANY KIND, EXPRESS OR IMPLIED, INCLUDING BUT NOT LIMITED TO THE WARRANTIES OF MERCHANTABILITY, FITNESS FOR A PARTICULAR PURPOSE AND NONINFRINGEMENT. IN NO EVENT SHALL BRIAN PAUL BE LIABLE FOR ANY CLAIM, DAMAGES OR OTHER LIABILITY, WHETHER IN AN ACTION OF CONTRACT, TORT OR OTHERWISE, ARISING FROM, OUT OF OR IN CONNECTION WITH THE SOFTWARE OR THE USE OR OTHER DEALINGS IN THE SOFTWARE.

Copyright (c) 2007 The Khronos Group Inc.

Permission is hereby granted, free of charge, to any person obtaining a copy of this software and/or associated documentation files (the "Materials"), to deal in the Materials without restriction, including without limitation the rights to use, copy, modify, merge, publish, distribute, sublicense, and/or sell copies of the Materials, and to

permit persons to whom the Materials are furnished to do so, subject to the following conditions:

The above copyright notice and this permission notice shall be included in all copies or substantial portions of the Materials.

THE MATERIALS ARE PROVIDED "AS IS", WITHOUT WARRANTY OF ANY KIND, EXPRESS OR IMPLIED, INCLUDING BUT NOT LIMITED TO THE WARRANTIES OF MERCHANTABILITY, FITNESS FOR A PARTICULAR PURPOSE AND NONINFRINGEMENT. IN NO EVENT SHALL THE AUTHORS OR COPYRIGHT HOLDERS BE LIABLE FOR ANY CLAIM, DAMAGES OR OTHER LIABILITY, WHETHER IN AN ACTION OF CONTRACT, TORT OR OTHERWISE, ARISING FROM, OUT OF OR IN CONNECTION WITH THE MATERIALS OR THE USE OR OTHER DEALINGS IN THE MATERIALS.

Glibc-queue

Copyright (C) 1991-2015 Free Software Foundation, Inc.

The GNU C Library is free software; you can redistribute it and/or modify it under the terms of the GNU Lesser General Public License as published by the Free Software Foundation; either version 2.1 of the License, or (at your option) any later version.

The GNU C Library is distributed in the hope that it will be useful, but WITHOUT ANY WARRANTY; without even the implied warranty of MERCHANTABILITY or FITNESS FOR A PARTICULAR PURPOSE. See the GNU Lesser General Public License for more details.

You should have received a copy of the GNU Lesser General Public License along with the GNU C Library; if not, write to the Free Software Foundation, Inc., 51 Franklin St, Fifth Floor, Boston, MA 02110-1301 USA

* All code incorporated from 4.4 BSD is distributed under the following license:

Copyright (C) 1991 Regents of the University of California.
All rights reserved.

Redistribution and use in source and binary forms, with or without modification, are permitted provided that the following conditions are met:

1. Redistributions of source code must retain the above copyright notice, this list of conditions and the following disclaimer.
2. Redistributions in binary form must reproduce the above copyright notice, this list of conditions and the following disclaimer in the documentation and/or other materials provided with the distribution.
3. [This condition was removed.]
4. Neither the name of the University nor the names of its contributors may be used to endorse or promote products derived from this software without specific prior written permission.

THIS SOFTWARE IS PROVIDED BY THE REGENTS AND CONTRIBUTORS ``AS IS'' AND ANY EXPRESS OR IMPLIED WARRANTIES, INCLUDING, BUT NOT LIMITED TO, THE IMPLIED WARRANTIES OF MERCHANTABILITY AND FITNESS FOR A PARTICULAR PURPOSE ARE DISCLAIMED. IN NO EVENT SHALL THE REGENTS OR CONTRIBUTORS BE LIABLE FOR ANY DIRECT, INDIRECT, INCIDENTAL, SPECIAL, EXEMPLARY, OR CONSEQUENTIAL DAMAGES (INCLUDING, BUT NOT LIMITED TO, PROCUREMENT OF SUBSTITUTE GOODS OR SERVICES; LOSS OF USE, DATA, OR PROFITS; OR BUSINESS INTERRUPTION) HOWEVER CAUSED AND ON ANY THEORY OF LIABILITY, WHETHER IN CONTRACT, STRICT LIABILITY, OR TORT (INCLUDING NEGLIGENCE OR OTHERWISE) ARISING IN ANY WAY OUT OF THE USE OF THIS SOFTWARE, EVEN IF ADVISED OF THE POSSIBILITY OF SUCH DAMAGE.

Gtest

Copyright 2008, Google Inc.

All rights reserved.

Redistribution and use in source and binary forms, with or without modification, are permitted provided that the following conditions are met:

- * Redistributions of source code must retain the above copyright notice, this list of conditions and the following disclaimer.
- * Redistributions in binary form must reproduce the above copyright notice, this list of conditions and the following disclaimer in the documentation and/or other materials provided with the distribution.
- * Neither the name of Google Inc. nor the names of its contributors may be used to endorse or promote products derived from this software without specific prior written permission.

THIS SOFTWARE IS PROVIDED BY THE COPYRIGHT HOLDERS AND CONTRIBUTORS "AS IS" AND ANY EXPRESS OR IMPLIED WARRANTIES, INCLUDING, BUT NOT LIMITED TO, THE IMPLIED WARRANTIES OF MERCHANTABILITY AND FITNESS FOR A PARTICULAR PURPOSE ARE DISCLAIMED. IN NO EVENT SHALL THE COPYRIGHT OWNER OR CONTRIBUTORS BE LIABLE FOR ANY DIRECT, INDIRECT, INCIDENTAL, SPECIAL, EXEMPLARY, OR CONSEQUENTIAL DAMAGES (INCLUDING, BUT NOT LIMITED TO, PROCUREMENT OF SUBSTITUTE GOODS OR SERVICES; LOSS OF USE, DATA, OR PROFITS; OR BUSINESS INTERRUPTION) HOWEVER CAUSED AND ON ANY THEORY OF LIABILITY, WHETHER IN CONTRACT, STRICT LIABILITY, OR TORT (INCLUDING NEGLIGENCE OR OTHERWISE) ARISING IN ANY WAY OUT OF THE USE OF THIS SOFTWARE, EVEN IF ADVISED OF THE POSSIBILITY OF SUCH DAMAGE.

Harfbuzz

HarfBuzz is licensed under the so-called "Old MIT" license. Details follow. For parts of HarfBuzz that are licensed under different licenses see individual files names COPYING in subdirectories where applicable.

Copyright © 2010,2011,2012,2013,2014,2015,2016,2017,2018,2019,2020 Google, Inc.
Copyright © 2018,2019,2020 Ebrahim Byagowi
Copyright © 2019,2020 Facebook, Inc.
Copyright © 2012 Mozilla Foundation
Copyright © 2011 Codethink Limited
Copyright © 2008,2010 Nokia Corporation and/or its subsidiary(-ies)
Copyright © 2009 Keith Stribley
Copyright © 2009 Martin Hosken and SIL International
Copyright © 2007 Chris Wilson
Copyright © 2005,2006,2020,2021 Behdad Esfahbod
Copyright © 2005 David Turner
Copyright © 2004,2007,2008,2009,2010 Red Hat, Inc.
Copyright © 1998-2004 David Turner and Werner Lemberg

For full copyright notices consult the individual files in the package.

Permission is hereby granted, without written agreement and without license or royalty fees, to use, copy, modify, and distribute this software and its documentation for any purpose, provided that the above copyright notice and the following two paragraphs appear in all copies of this software.

IN NO EVENT SHALL THE COPYRIGHT HOLDER BE LIABLE TO ANY PARTY FOR DIRECT, INDIRECT, SPECIAL, INCIDENTAL, OR CONSEQUENTIAL DAMAGES ARISING OUT OF THE USE OF THIS SOFTWARE AND ITS DOCUMENTATION, EVEN IF THE COPYRIGHT HOLDER HAS BEEN ADVISED OF THE POSSIBILITY OF SUCH DAMAGE.

THE COPYRIGHT HOLDER SPECIFICALLY DISCLAIMS ANY WARRANTIES, INCLUDING, BUT NOT LIMITED TO, THE IMPLIED WARRANTIES OF MERCHANTABILITY AND FITNESS FOR A PARTICULAR PURPOSE. THE SOFTWARE PROVIDED HEREUNDER IS ON AN "AS IS" BASIS, AND THE COPYRIGHT HOLDER HAS NO OBLIGATION TO PROVIDE MAINTENANCE, SUPPORT, UPDATES, ENHANCEMENTS, OR MODIFICATIONS.

Hdf5

Copyright Notice and License Terms for
HDF5 (Hierarchical Data Format 5) Software Library and Utilities

HDF5 (Hierarchical Data Format 5) Software Library and Utilities
Copyright 2006 by The HDF Group.

NCSA HDF5 (Hierarchical Data Format 5) Software Library and Utilities
Copyright 1998–2006 by The Board of Trustees of the University of Illinois.

All rights reserved.

Redistribution and use in source and binary forms, with or without
modification, are permitted for any purpose (including commercial purposes)
provided that the following conditions are met:

1. Redistributions of source code must retain the above copyright notice,
this list of conditions, and the following disclaimer.
2. Redistributions in binary form must reproduce the above copyright notice,
this list of conditions, and the following disclaimer in the documentation
and/or materials provided with the distribution.
3. Neither the name of The HDF Group, the name of the University, nor the
name of any Contributor may be used to endorse or promote products derived
from this software without specific prior written permission from
The HDF Group, the University, or the Contributor, respectively.

DISCLAIMER:

THIS SOFTWARE IS PROVIDED BY THE HDF GROUP AND THE CONTRIBUTORS
"AS IS" WITH NO WARRANTY OF ANY KIND, EITHER EXPRESSED OR IMPLIED. IN NO
EVENT SHALL THE HDF GROUP OR THE CONTRIBUTORS BE LIABLE FOR ANY DAMAGES
SUFFERED BY THE USERS ARISING OUT OF THE USE OF THIS SOFTWARE, EVEN IF
ADVISED OF THE POSSIBILITY OF SUCH DAMAGE.

You are under no obligation whatsoever to provide any bug fixes, patches, or
upgrades to the features, functionality or performance of the source code
("Enhancements") to anyone; however, if you choose to make your Enhancements
available either publicly, or directly to The HDF Group, without imposing a
separate written license agreement for such Enhancements, then you hereby
grant the following license: a non-exclusive, royalty-free perpetual license
to install, use, modify, prepare derivative works, incorporate into other
computer software, distribute, and sublicense such enhancements or derivative
works thereof, in binary and source code form.

Limited portions of HDF5 were developed by Lawrence Berkeley National
Laboratory (LBNL). LBNL's Copyright Notice and Licensing Terms can be
found here: COPYING_LBNL_HDF5 file in this directory or at
http://support.hdfgroup.org/ftp/HDF5/releases/COPYING_LBNL_HDF5.

Contributors: National Center for Supercomputing Applications (NCSA) at
the University of Illinois, Fortner Software, Unidata Program Center
(netCDF), The Independent JPEG Group (JPEG), Jean-loup Gailly and Mark Adler
(gzip), and Digital Equipment Corporation (DEC).

Portions of HDF5 were developed with support from the Lawrence Berkeley
National Laboratory (LBNL) and the United States Department of Energy
under Prime Contract No. DE-AC02-05CH11231.

Portions of HDF5 were developed with support from Lawrence Livermore National Laboratory and the United States Department of Energy under Prime Contract No. DE-AC52-07NA27344.

Portions of HDF5 were developed with support from the University of California, Lawrence Livermore National Laboratory (UC LLNL). The following statement applies to those portions of the product and must be retained in any redistribution of source code, binaries, documentation, and/or accompanying materials:

This work was partially produced at the University of California, Lawrence Livermore National Laboratory (UC LLNL) under contract no. W-7405-ENG-48 (Contract 48) between the U.S. Department of Energy (DOE) and The Regents of the University of California (University) for the operation of UC LLNL.

DISCLAIMER:

THIS WORK WAS PREPARED AS AN ACCOUNT OF WORK SPONSORED BY AN AGENCY OF THE UNITED STATES GOVERNMENT. NEITHER THE UNITED STATES GOVERNMENT NOR THE UNIVERSITY OF CALIFORNIA NOR ANY OF THEIR EMPLOYEES, MAKES ANY WARRANTY, EXPRESS OR IMPLIED, OR ASSUMES ANY LIABILITY OR RESPONSIBILITY FOR THE ACCURACY, COMPLETENESS, OR USEFULNESS OF ANY INFORMATION, APPARATUS, PRODUCT, OR PROCESS DISCLOSED, OR REPRESENTS THAT ITS USE WOULD NOT INFRINGE PRIVATELY- OWNED RIGHTS. REFERENCE HEREIN TO ANY SPECIFIC COMMERCIAL PRODUCTS, PROCESS, OR SERVICE BY TRADE NAME, TRADEMARK, MANUFACTURER, OR OTHERWISE, DOES NOT NECESSARILY CONSTITUTE OR IMPLY ITS ENDORSEMENT, RECOMMENDATION, OR FAVORING BY THE UNITED STATES GOVERNMENT OR THE UNIVERSITY OF CALIFORNIA. THE VIEWS AND OPINIONS OF AUTHORS EXPRESSED HEREIN DO NOT NECESSARILY STATE OR REFLECT THOSE OF THE UNITED STATES GOVERNMENT OR THE UNIVERSITY OF CALIFORNIA, AND SHALL NOT BE USED FOR ADVERTISING OR PRODUCT ENDORSEMENT PURPOSES.

HighFive

Boost Software License - Version 1.0 - August 17th, 2003

Permission is hereby granted, free of charge, to any person or organization obtaining a copy of the software and accompanying documentation covered by this license (the "Software") to use, reproduce, display, distribute, execute, and transmit the Software, and to prepare derivative works of the Software, and to permit third-parties to whom the Software is furnished to do so, all subject to the following:

The copyright notices in the Software and this entire statement, including the above license grant, this restriction and the following disclaimer, must be included in all copies of the Software, in whole or in part, and all derivative works of the Software, unless such copies or derivative works are solely in the form of machine-executable object code generated by a source language processor.

THE SOFTWARE IS PROVIDED "AS IS", WITHOUT WARRANTY OF ANY KIND, EXPRESS OR IMPLIED, INCLUDING BUT NOT LIMITED TO THE WARRANTIES OF MERCHANTABILITY, FITNESS FOR A PARTICULAR PURPOSE, TITLE AND NON-INFRINGEMENT. IN NO EVENT SHALL THE COPYRIGHT HOLDERS OR ANYONE DISTRIBUTING THE SOFTWARE BE LIABLE FOR ANY DAMAGES OR OTHER LIABILITY, WHETHER IN CONTRACT, TORT OR OTHERWISE, ARISING FROM, OUT OF OR IN CONNECTION WITH THE SOFTWARE OR THE USE OR OTHER DEALINGS IN THE SOFTWARE.

Icu

UNICODE, INC. LICENSE AGREEMENT - DATA FILES AND SOFTWARE

See Terms of Use <<https://www.unicode.org/copyright.html>>
for definitions of Unicode Inc.'s Data Files and Software.

NOTICE TO USER: Carefully read the following legal agreement.
BY DOWNLOADING, INSTALLING, COPYING OR OTHERWISE USING UNICODE INC.'S
DATA FILES ("DATA FILES"), AND/OR SOFTWARE ("SOFTWARE"),
YOU UNEQUIVOCALLY ACCEPT, AND AGREE TO BE BOUND BY, ALL OF THE
TERMS AND CONDITIONS OF THIS AGREEMENT.
IF YOU DO NOT AGREE, DO NOT DOWNLOAD, INSTALL, COPY, DISTRIBUTE OR USE
THE DATA FILES OR SOFTWARE.

COPYRIGHT AND PERMISSION NOTICE

Copyright © 1991-2022 Unicode, Inc. All rights reserved.
Distributed under the Terms of Use in <https://www.unicode.org/copyright.html>.

Permission is hereby granted, free of charge, to any person obtaining
a copy of the Unicode data files and any associated documentation
(the "Data Files") or Unicode software and any associated documentation
(the "Software") to deal in the Data Files or Software
without restriction, including without limitation the rights to use,
copy, modify, merge, publish, distribute, and/or sell copies of
the Data Files or Software, and to permit persons to whom the Data Files
or Software are furnished to do so, provided that either
(a) this copyright and permission notice appear with all copies
of the Data Files or Software, or
(b) this copyright and permission notice appear in associated
Documentation.

THE DATA FILES AND SOFTWARE ARE PROVIDED "AS IS", WITHOUT WARRANTY OF
ANY KIND, EXPRESS OR IMPLIED, INCLUDING BUT NOT LIMITED TO THE
WARRANTIES OF MERCHANTABILITY, FITNESS FOR A PARTICULAR PURPOSE AND
NONINFRINGEMENT OF THIRD PARTY RIGHTS.
IN NO EVENT SHALL THE COPYRIGHT HOLDER OR HOLDERS INCLUDED IN THIS
NOTICE BE LIABLE FOR ANY CLAIM, OR ANY SPECIAL INDIRECT OR CONSEQUENTIAL
DAMAGES, OR ANY DAMAGES WHATSOEVER RESULTING FROM LOSS OF USE,
DATA OR PROFITS, WHETHER IN AN ACTION OF CONTRACT, NEGLIGENCE OR OTHER
TORTIOUS ACTION, ARISING OUT OF OR IN CONNECTION WITH THE USE OR
PERFORMANCE OF THE DATA FILES OR SOFTWARE.

Except as contained in this notice, the name of a copyright holder
shall not be used in advertising or otherwise to promote the sale,
use or other dealings in these Data Files or Software without prior
written authorization of the copyright holder.

Third-Party Software Licenses

This section contains third-party software notices and/or additional
terms for licensed third-party software components included within ICU
libraries.

ICU License - ICU 1.8.1 to ICU 57.1

COPYRIGHT AND PERMISSION NOTICE

Copyright (c) 1995-2016 International Business Machines Corporation and others
All rights reserved.

Permission is hereby granted, free of charge, to any person obtaining
a copy of this software and associated documentation files (the
"Software"), to deal in the Software without restriction, including
without limitation the rights to use, copy, modify, merge, publish,
distribute, and/or sell copies of the Software, and to permit persons
to whom the Software is furnished to do so, provided that the above
copyright notice(s) and this permission notice appear in all copies of
the Software and that both the above copyright notice(s) and this

permission notice appear in supporting documentation.

THE SOFTWARE IS PROVIDED "AS IS", WITHOUT WARRANTY OF ANY KIND, EXPRESS OR IMPLIED, INCLUDING BUT NOT LIMITED TO THE WARRANTIES OF MERCHANTABILITY, FITNESS FOR A PARTICULAR PURPOSE AND NONINFRINGEMENT OF THIRD PARTY RIGHTS. IN NO EVENT SHALL THE COPYRIGHT HOLDER OR HOLDERS INCLUDED IN THIS NOTICE BE LIABLE FOR ANY CLAIM, OR ANY SPECIAL INDIRECT OR CONSEQUENTIAL DAMAGES, OR ANY DAMAGES WHATSOEVER RESULTING FROM LOSS OF USE, DATA OR PROFITS, WHETHER IN AN ACTION OF CONTRACT, NEGLIGENCE OR OTHER TORTIOUS ACTION, ARISING OUT OF OR IN CONNECTION WITH THE USE OR PERFORMANCE OF THIS SOFTWARE.

Except as contained in this notice, the name of a copyright holder shall not be used in advertising or otherwise to promote the sale, use or other dealings in this Software without prior written authorization of the copyright holder.

All trademarks and registered trademarks mentioned herein are the property of their respective owners.

Chinese/Japanese Word Break Dictionary Data (cjdict.txt)

```
# The Google Chrome software developed by Google is licensed under
# the BSD license. Other software included in this distribution is
# provided under other licenses, as set forth below.
#
# The BSD License
# http://opensource.org/licenses/bsd-license.php
# Copyright (C) 2006-2008, Google Inc.
#
# All rights reserved.
#
# Redistribution and use in source and binary forms, with or without
# modification, are permitted provided that the following conditions are met:
#
# Redistributions of source code must retain the above copyright notice,
# this list of conditions and the following disclaimer.
# Redistributions in binary form must reproduce the above
# copyright notice, this list of conditions and the following
# disclaimer in the documentation and/or other materials provided with
# the distribution.
# Neither the name of Google Inc. nor the names of its
# contributors may be used to endorse or promote products derived from
# this software without specific prior written permission.
#
# THIS SOFTWARE IS PROVIDED BY THE COPYRIGHT HOLDERS AND
# CONTRIBUTORS "AS IS" AND ANY EXPRESS OR IMPLIED WARRANTIES,
# INCLUDING, BUT NOT LIMITED TO, THE IMPLIED WARRANTIES OF
# MERCHANTABILITY AND FITNESS FOR A PARTICULAR PURPOSE ARE
# DISCLAIMED. IN NO EVENT SHALL THE COPYRIGHT OWNER OR CONTRIBUTORS BE
# LIABLE FOR ANY DIRECT, INDIRECT, INCIDENTAL, SPECIAL, EXEMPLARY, OR
# CONSEQUENTIAL DAMAGES (INCLUDING, BUT NOT LIMITED TO, PROCUREMENT OF
# SUBSTITUTE GOODS OR SERVICES; LOSS OF USE, DATA, OR PROFITS; OR
# BUSINESS INTERRUPTION) HOWEVER CAUSED AND ON ANY THEORY OF
# LIABILITY, WHETHER IN CONTRACT, STRICT LIABILITY, OR TORT (INCLUDING
# NEGLIGENCE OR OTHERWISE) ARISING IN ANY WAY OUT OF THE USE OF THIS
# SOFTWARE, EVEN IF ADVISED OF THE POSSIBILITY OF SUCH DAMAGE.
#
#
# The word list in cjdict.txt are generated by combining three word lists
# listed below with further processing for compound word breaking. The
# frequency is generated with an iterative training against Google web
# corpora.
#
# * Libtabe (Chinese)
# - https://sourceforge.net/project/?group_id=1519
# - Its license terms and conditions are shown below.
```

```

#
# * IPADIC (Japanese)
#   - http://chasen.aist-nara.ac.jp/chasen/distribution.html
#   - Its license terms and conditions are shown below.
#
# -----COPYING.libtabe ---- BEGIN-----
#
# /*
# * Copyright (c) 1999 TaBE Project.
# * Copyright (c) 1999 Pai-Hsiang Hsiao.
# * All rights reserved.
# *
# * Redistribution and use in source and binary forms, with or without
# * modification, are permitted provided that the following conditions
# * are met:
# *
# * . Redistributions of source code must retain the above copyright
# * notice, this list of conditions and the following disclaimer.
# * . Redistributions in binary form must reproduce the above copyright
# * notice, this list of conditions and the following disclaimer in
# * the documentation and/or other materials provided with the
# * distribution.
# * . Neither the name of the TaBE Project nor the names of its
# * contributors may be used to endorse or promote products derived
# * from this software without specific prior written permission.
# *
# * THIS SOFTWARE IS PROVIDED BY THE COPYRIGHT HOLDERS AND CONTRIBUTORS
# * "AS IS" AND ANY EXPRESS OR IMPLIED WARRANTIES, INCLUDING, BUT NOT
# * LIMITED TO, THE IMPLIED WARRANTIES OF MERCHANTABILITY AND FITNESS
# * FOR A PARTICULAR PURPOSE ARE DISCLAIMED. IN NO EVENT SHALL THE
# * REGENTS OR CONTRIBUTORS BE LIABLE FOR ANY DIRECT, INDIRECT,
# * INCIDENTAL, SPECIAL, EXEMPLARY, OR CONSEQUENTIAL DAMAGES
# * (INCLUDING, BUT NOT LIMITED TO, PROCUREMENT OF SUBSTITUTE GOODS OR
# * SERVICES; LOSS OF USE, DATA, OR PROFITS; OR BUSINESS INTERRUPTION)
# * HOWEVER CAUSED AND ON ANY THEORY OF LIABILITY, WHETHER IN CONTRACT,
# * STRICT LIABILITY, OR TORT (INCLUDING NEGLIGENCE OR OTHERWISE)
# * ARISING IN ANY WAY OUT OF THE USE OF THIS SOFTWARE, EVEN IF ADVISED
# * OF THE POSSIBILITY OF SUCH DAMAGE.
# */
#
# /*
# * Copyright (c) 1999 Computer Systems and Communication Lab,
# * Institute of Information Science, Academia
# * Sinica. All rights reserved.
# *
# * Redistribution and use in source and binary forms, with or without
# * modification, are permitted provided that the following conditions
# * are met:
# *
# * . Redistributions of source code must retain the above copyright
# * notice, this list of conditions and the following disclaimer.
# * . Redistributions in binary form must reproduce the above copyright
# * notice, this list of conditions and the following disclaimer in
# * the documentation and/or other materials provided with the
# * distribution.
# * . Neither the name of the Computer Systems and Communication Lab
# * nor the names of its contributors may be used to endorse or
# * promote products derived from this software without specific
# * prior written permission.
# *
# * THIS SOFTWARE IS PROVIDED BY THE COPYRIGHT HOLDERS AND CONTRIBUTORS
# * "AS IS" AND ANY EXPRESS OR IMPLIED WARRANTIES, INCLUDING, BUT NOT
# * LIMITED TO, THE IMPLIED WARRANTIES OF MERCHANTABILITY AND FITNESS
# * FOR A PARTICULAR PURPOSE ARE DISCLAIMED. IN NO EVENT SHALL THE
# * REGENTS OR CONTRIBUTORS BE LIABLE FOR ANY DIRECT, INDIRECT,
# * INCIDENTAL, SPECIAL, EXEMPLARY, OR CONSEQUENTIAL DAMAGES
# * (INCLUDING, BUT NOT LIMITED TO, PROCUREMENT OF SUBSTITUTE GOODS OR
# * SERVICES; LOSS OF USE, DATA, OR PROFITS; OR BUSINESS INTERRUPTION)
# * HOWEVER CAUSED AND ON ANY THEORY OF LIABILITY, WHETHER IN CONTRACT,
# * STRICT LIABILITY, OR TORT (INCLUDING NEGLIGENCE OR OTHERWISE)

```

```

# * ARISING IN ANY WAY OUT OF THE USE OF THIS SOFTWARE, EVEN IF ADVISED
# * OF THE POSSIBILITY OF SUCH DAMAGE.
# */
#
# Copyright 1996 Chih-Hao Tsai @ Beckman Institute,
# University of Illinois
# c-tsai4@uiuc.edu http://casper.beckman.uiuc.edu/~c-tsai4
# -----COPYING.libtabe-----END-----
#
# -----COPYING.ipadic-----BEGIN-----
#
# Copyright 2000, 2001, 2002, 2003 Nara Institute of Science
# and Technology. All Rights Reserved.
#
# Use, reproduction, and distribution of this software is permitted.
# Any copy of this software, whether in its original form or modified,
# must include both the above copyright notice and the following
# paragraphs.
#
# Nara Institute of Science and Technology (NAIST),
# the copyright holders, disclaims all warranties with regard to this
# software, including all implied warranties of merchantability and
# fitness, in no event shall NAIST be liable for
# any special, indirect or consequential damages or any damages
# whatsoever resulting from loss of use, data or profits, whether in an
# action of contract, negligence or other tortuous action, arising out
# of or in connection with the use or performance of this software.
#
# A large portion of the dictionary entries
# originate from ICOT Free Software. The following conditions for ICOT
# Free Software applies to the current dictionary as well.
#
# Each User may also freely distribute the Program, whether in its
# original form or modified, to any third party or parties, PROVIDED
# that the provisions of Section 3 ("NO WARRANTY") will ALWAYS appear
# on, or be attached to, the Program, which is distributed substantially
# in the same form as set out herein and that such intended
# distribution, if actually made, will neither violate or otherwise
# contravene any of the laws and regulations of the countries having
# jurisdiction over the User or the intended distribution itself.
#
# NO WARRANTY
#
# The program was produced on an experimental basis in the course of the
# research and development conducted during the project and is provided
# to users as so produced on an experimental basis. Accordingly, the
# program is provided without any warranty whatsoever, whether express,
# implied, statutory or otherwise. The term "warranty" used herein
# includes, but is not limited to, any warranty of the quality,
# performance, merchantability and fitness for a particular purpose of
# the program and the nonexistence of any infringement or violation of
# any right of any third party.
#
# Each user of the program will agree and understand, and be deemed to
# have agreed and understood, that there is no warranty whatsoever for
# the program and, accordingly, the entire risk arising from or
# otherwise connected with the program is assumed by the user.
#
# Therefore, neither ICOT, the copyright holder, or any other
# organization that participated in or was otherwise related to the
# development of the program and their respective officials, directors,
# officers and other employees shall be held liable for any and all
# damages, including, without limitation, general, special, incidental
# and consequential damages, arising out of or otherwise in connection
# with the use or inability to use the program or any product, material
# or result produced or otherwise obtained by using the program,
# regardless of whether they have been advised of, or otherwise had
# knowledge of, the possibility of such damages at any time during the

```

```

# project or thereafter. Each user will be deemed to have agreed to the
# foregoing by his or her commencement of use of the program. The term
# "use" as used herein includes, but is not limited to, the use,
# modification, copying and distribution of the program and the
# production of secondary products from the program.
#
# In the case where the program, whether in its original form or
# modified, was distributed or delivered to or received by a user from
# any person, organization or entity other than ICOT, unless it makes or
# grants independently of ICOT any specific warranty to the user in
# writing, such person, organization or entity, will also be exempted
# from and not be held liable to the user for any such damages as noted
# above as far as the program is concerned.
#
# -----COPYING.ipadic-----END-----

```

Lao Word Break Dictionary Data (laodict.txt)

```

# Copyright (C) 2016 and later: Unicode, Inc. and others.
# License & terms of use: http://www.unicode.org/copyright.html
# Copyright (c) 2015 International Business Machines Corporation
# and others. All Rights Reserved.
#
# Project: https://github.com/rober42539/lao-dictionary
# Dictionary: https://github.com/rober42539/lao-dictionary/laodict.txt
# License: https://github.com/rober42539/lao-dictionary/LICENSE.txt
#         (copied below)
#
# This file is derived from the above dictionary version of Nov 22, 2020
# -----
# Copyright (C) 2013 Brian Eugene Wilson, Robert Martin Campbell.
# All rights reserved.
#
# Redistribution and use in source and binary forms, with or without
# modification, are permitted provided that the following conditions are met:
#
# Redistributions of source code must retain the above copyright notice, this
# list of conditions and the following disclaimer. Redistributions in binary
# form must reproduce the above copyright notice, this list of conditions and
# the following disclaimer in the documentation and/or other materials
# provided with the distribution.
#
# THIS SOFTWARE IS PROVIDED BY THE COPYRIGHT HOLDERS AND CONTRIBUTORS
# "AS IS" AND ANY EXPRESS OR IMPLIED WARRANTIES, INCLUDING, BUT NOT
# LIMITED TO, THE IMPLIED WARRANTIES OF MERCHANTABILITY AND FITNESS
# FOR A PARTICULAR PURPOSE ARE DISCLAIMED. IN NO EVENT SHALL THE
# COPYRIGHT HOLDER OR CONTRIBUTORS BE LIABLE FOR ANY DIRECT,
# INDIRECT, INCIDENTAL, SPECIAL, EXEMPLARY, OR CONSEQUENTIAL DAMAGES
# (INCLUDING, BUT NOT LIMITED TO, PROCUREMENT OF SUBSTITUTE GOODS OR
# SERVICES; LOSS OF USE, DATA, OR PROFITS; OR BUSINESS INTERRUPTION)
# HOWEVER CAUSED AND ON ANY THEORY OF LIABILITY, WHETHER IN CONTRACT,
# STRICT LIABILITY, OR TORT (INCLUDING NEGLIGENCE OR OTHERWISE)
# ARISING IN ANY WAY OUT OF THE USE OF THIS SOFTWARE, EVEN IF ADVISED
# OF THE POSSIBILITY OF SUCH DAMAGE.
# -----

```

Burmese Word Break Dictionary Data (burmesedict.txt)

```

# Copyright (c) 2014 International Business Machines Corporation
# and others. All Rights Reserved.
#
# This list is part of a project hosted at:
#   github.com/kanyawtech/myanmar-karen-word-lists
# -----
# Copyright (c) 2013, LeRoy Benjamin Sharon

```

```

# All rights reserved.
#
# Redistribution and use in source and binary forms, with or without
# modification, are permitted provided that the following conditions
# are met: Redistributions of source code must retain the above
# copyright notice, this list of conditions and the following
# disclaimer. Redistributions in binary form must reproduce the
# above copyright notice, this list of conditions and the following
# disclaimer in the documentation and/or other materials provided
# with the distribution.
#
# Neither the name Myanmar Karen Word Lists, nor the names of its
# contributors may be used to endorse or promote products derived
# from this software without specific prior written permission.
#
# THIS SOFTWARE IS PROVIDED BY THE COPYRIGHT HOLDERS AND
# CONTRIBUTORS "AS IS" AND ANY EXPRESS OR IMPLIED WARRANTIES,
# INCLUDING, BUT NOT LIMITED TO, THE IMPLIED WARRANTIES OF
# MERCHANTABILITY AND FITNESS FOR A PARTICULAR PURPOSE ARE
# DISCLAIMED. IN NO EVENT SHALL THE COPYRIGHT HOLDER OR CONTRIBUTORS
# BE LIABLE FOR ANY DIRECT, INDIRECT, INCIDENTAL, SPECIAL,
# EXEMPLARY, OR CONSEQUENTIAL DAMAGES (INCLUDING, BUT NOT LIMITED
# TO, PROCUREMENT OF SUBSTITUTE GOODS OR SERVICES; LOSS OF USE,
# DATA, OR PROFITS; OR BUSINESS INTERRUPTION) HOWEVER CAUSED AND ON
# ANY THEORY OF LIABILITY, WHETHER IN CONTRACT, STRICT LIABILITY, OR
# TORT (INCLUDING NEGLIGENCE OR OTHERWISE) ARISING IN ANY WAY OUT OF
# THE USE OF THIS SOFTWARE, EVEN IF ADVISED OF THE POSSIBILITY OF
# SUCH DAMAGE.
# -----

```

Time Zone Database

ICU uses the public domain data and code derived from Time Zone Database for its time zone support. The ownership of the TZ database is explained in BCP 175: Procedure for Maintaining the Time Zone Database section 7.

```

# 7. Database Ownership
#
# The TZ database itself is not an IETF Contribution or an IETF
# document. Rather it is a pre-existing and regularly updated work
# that is in the public domain, and is intended to remain in the
# public domain. Therefore, BCPs 78 [RFC5378] and 79 [RFC3979] do
# not apply to the TZ Database or contributions that individuals make
# to it. Should any claims be made and substantiated against the TZ
# Database, the organization that is providing the IANA
# Considerations defined in this RFC, under the memorandum of
# understanding with the IETF, currently ICANN, may act in accordance
# with all competent court orders. No ownership claims will be made
# by ICANN or the IETF Trust on the database or the code. Any person
# making a contribution to the database or code waives all rights to
# future claims in that contribution or in the TZ Database.

```

Google double-conversion

Copyright 2006-2011, the V8 project authors. All rights reserved. Redistribution and use in source and binary forms, with or without modification, are permitted provided that the following conditions are met:

- * Redistributions of source code must retain the above copyright notice, this list of conditions and the following disclaimer.
- * Redistributions in binary form must reproduce the above copyright notice, this list of conditions and the following disclaimer in the documentation and/or other materials provided with the distribution.

* Neither the name of Google Inc. nor the names of its contributors may be used to endorse or promote products derived from this software without specific prior written permission.

THIS SOFTWARE IS PROVIDED BY THE COPYRIGHT HOLDERS AND CONTRIBUTORS "AS IS" AND ANY EXPRESS OR IMPLIED WARRANTIES, INCLUDING, BUT NOT LIMITED TO, THE IMPLIED WARRANTIES OF MERCHANTABILITY AND FITNESS FOR A PARTICULAR PURPOSE ARE DISCLAIMED. IN NO EVENT SHALL THE COPYRIGHT OWNER OR CONTRIBUTORS BE LIABLE FOR ANY DIRECT, INDIRECT, INCIDENTAL, SPECIAL, EXEMPLARY, OR CONSEQUENTIAL DAMAGES (INCLUDING, BUT NOT LIMITED TO, PROCUREMENT OF SUBSTITUTE GOODS OR SERVICES; LOSS OF USE, DATA, OR PROFITS; OR BUSINESS INTERRUPTION) HOWEVER CAUSED AND ON ANY THEORY OF LIABILITY, WHETHER IN CONTRACT, STRICT LIABILITY, OR TORT (INCLUDING NEGLIGENCE OR OTHERWISE) ARISING IN ANY WAY OUT OF THE USE OF THIS SOFTWARE, EVEN IF ADVISED OF THE POSSIBILITY OF SUCH DAMAGE.

File: aclocal.m4 (only for ICU4C)
Section: pkg.m4 - Macros to locate and utilise pkg-config.

Copyright © 2004 Scott James Remnant <scott@netsplit.com>.
Copyright © 2012-2015 Dan Nicholson <dbn.lists@gmail.com>

This program is free software; you can redistribute it and/or modify it under the terms of the GNU General Public License as published by the Free Software Foundation; either version 2 of the License, or (at your option) any later version.

This program is distributed in the hope that it will be useful, but WITHOUT ANY WARRANTY; without even the implied warranty of MERCHANTABILITY or FITNESS FOR A PARTICULAR PURPOSE. See the GNU General Public License for more details.

You should have received a copy of the GNU General Public License along with this program; if not, write to the Free Software Foundation, Inc., 59 Temple Place - Suite 330, Boston, MA 02111-1307, USA.

As a special exception to the GNU General Public License, if you distribute this file as part of a program that contains a configuration script generated by Autoconf, you may include it under the same distribution terms that you use for the rest of that program.

(The condition for the exception is fulfilled because ICU4C includes a configuration script generated by Autoconf, namely the `configure` script.)

File: config.guess (only for ICU4C)

This file is free software; you can redistribute it and/or modify it under the terms of the GNU General Public License as published by the Free Software Foundation; either version 3 of the License, or (at your option) any later version.

This program is distributed in the hope that it will be useful, but WITHOUT ANY WARRANTY; without even the implied warranty of MERCHANTABILITY or FITNESS FOR A PARTICULAR PURPOSE. See the GNU General Public License for more details.

You should have received a copy of the GNU General Public License along with this program; if not, see <<https://www.gnu.org/licenses/>>.

As a special exception to the GNU General Public License, if you

distribute this file as part of a program that contains a configuration script generated by Autoconf, you may include it under the same distribution terms that you use for the rest of that program. This Exception is an additional permission under section 7 of the GNU General Public License, version 3 ("GPLv3").

(The condition for the exception is fulfilled because ICU4C includes a configuration script generated by Autoconf, namely the `configure` script.)

File: install-sh (only for ICU4C)

Copyright 1991 by the Massachusetts Institute of Technology

Permission to use, copy, modify, distribute, and sell this software and its documentation for any purpose is hereby granted without fee, provided that the above copyright notice appear in all copies and that both that copyright notice and this permission notice appear in supporting documentation, and that the name of M.I.T. not be used in advertising or publicity pertaining to distribution of the software without specific, written prior permission. M.I.T. makes no representations about the suitability of this software for any purpose. It is provided "as is" without express or implied warranty.

Jsoncpp

The JsonCpp library's source code, including accompanying documentation, tests and demonstration applications, are licensed under the following conditions...

Baptiste Lepilleur and The JsonCpp Authors explicitly disclaim copyright in all jurisdictions which recognize such a disclaimer. In such jurisdictions, this software is released into the Public Domain.

In jurisdictions which do not recognize Public Domain property (e.g. Germany as of 2010), this software is Copyright (c) 2007-2010 by Baptiste Lepilleur and The JsonCpp Authors, and is released under the terms of the MIT License (see below).

In jurisdictions which recognize Public Domain property, the user of this software may choose to accept it either as 1) Public Domain, 2) under the conditions of the MIT License (see below), or 3) under the terms of dual Public Domain/MIT License conditions described here, as they choose.

The MIT License is about as close to Public Domain as a license can get, and is described in clear, concise terms at:

http://en.wikipedia.org/wiki/MIT_License

The full text of the MIT License follows:

=====
Copyright (c) 2007-2010 Baptiste Lepilleur and The JsonCpp Authors

Permission is hereby granted, free of charge, to any person obtaining a copy of this software and associated documentation files (the "Software"), to deal in the Software without restriction, including without limitation the rights to use, copy, modify, merge, publish, distribute, sublicense, and/or sell copies of the Software, and to permit persons to whom the Software is furnished to do so, subject to the following conditions:

The above copyright notice and this permission notice shall be included in all copies or substantial portions of the Software.

THE SOFTWARE IS PROVIDED "AS IS", WITHOUT WARRANTY OF ANY KIND,

EXPRESS OR IMPLIED, INCLUDING BUT NOT LIMITED TO THE WARRANTIES OF MERCHANTABILITY, FITNESS FOR A PARTICULAR PURPOSE AND NONINFRINGEMENT. IN NO EVENT SHALL THE AUTHORS OR COPYRIGHT HOLDERS BE LIABLE FOR ANY CLAIM, DAMAGES OR OTHER LIABILITY, WHETHER IN AN ACTION OF CONTRACT, TORT OR OTHERWISE, ARISING FROM, OUT OF OR IN CONNECTION WITH THE SOFTWARE OR THE USE OR OTHER DEALINGS IN THE SOFTWARE.

=====
(END LICENSE TEXT)

The MIT license is compatible with both the GPL and commercial software, affording one all of the rights of Public Domain with the minor nuisance of being required to keep the above copyright notice and license text in the source code. Note also that by accepting the Public Domain "license" you can re-license your copy using whatever license you like.

Libharu

Copyright (C) 1999-2006 Takeshi Kanno
Copyright (C) 2007-2009 Antony Dovgal

This software is provided 'as-is', without any express or implied warranty.

In no event will the authors be held liable for any damages arising from the use of this software.

Permission is granted to anyone to use this software for any purpose, including commercial applications, and to alter it and redistribute it freely, subject to the following restrictions:

1. The origin of this software must not be misrepresented; you must not claim that you wrote the original software. If you use this software in a product, an acknowledgment in the product documentation would be appreciated but is not required.
2. Altered source versions must be plainly marked as such, and must not be misrepresented as being the original software.
3. This notice may not be removed or altered from any source distribution.

Libiconv

GNU LIBRARY GENERAL PUBLIC LICENSE
Version 2, June 1991

Copyright (C) 1991 Free Software Foundation, Inc.
51 Franklin Street, Fifth Floor, Boston, MA 02110-1301, USA
Everyone is permitted to copy and distribute verbatim copies of this license document, but changing it is not allowed.

[This is the first released version of the library GPL. It is numbered 2 because it goes with version 2 of the ordinary GPL.]

Preamble

The licenses for most software are designed to take away your freedom to share and change it. By contrast, the GNU General Public Licenses are intended to guarantee your freedom to share and change free software--to make sure the software is free for all its users.

This license, the Library General Public License, applies to some specially designated Free Software Foundation software, and to any other libraries whose authors decide to use it. You can use it for your libraries, too.

When we speak of free software, we are referring to freedom, not price. Our General Public Licenses are designed to make sure that you have the freedom to distribute copies of free software (and charge for

this service if you wish), that you receive source code or can get it if you want it, that you can change the software or use pieces of it in new free programs; and that you know you can do these things.

To protect your rights, we need to make restrictions that forbid anyone to deny you these rights or to ask you to surrender the rights. These restrictions translate to certain responsibilities for you if you distribute copies of the library, or if you modify it.

For example, if you distribute copies of the library, whether gratis or for a fee, you must give the recipients all the rights that we gave you. You must make sure that they, too, receive or can get the source code. If you link a program with the library, you must provide complete object files to the recipients so that they can relink them with the library, after making changes to the library and recompiling it. And you must show them these terms so they know their rights.

Our method of protecting your rights has two steps: (1) copyright the library, and (2) offer you this license which gives you legal permission to copy, distribute and/or modify the library.

Also, for each distributor's protection, we want to make certain that everyone understands that there is no warranty for this free library. If the library is modified by someone else and passed on, we want its recipients to know that what they have is not the original version, so that any problems introduced by others will not reflect on the original authors' reputations.

Finally, any free program is threatened constantly by software patents. We wish to avoid the danger that companies distributing free software will individually obtain patent licenses, thus in effect transforming the program into proprietary software. To prevent this, we have made it clear that any patent must be licensed for everyone's free use or not licensed at all.

Most GNU software, including some libraries, is covered by the ordinary GNU General Public License, which was designed for utility programs. This license, the GNU Library General Public License, applies to certain designated libraries. This license is quite different from the ordinary one; be sure to read it in full, and don't assume that anything in it is the same as in the ordinary license.

The reason we have a separate public license for some libraries is that they blur the distinction we usually make between modifying or adding to a program and simply using it. Linking a program with a library, without changing the library, is in some sense simply using the library, and is analogous to running a utility program or application program. However, in a textual and legal sense, the linked executable is a combined work, a derivative of the original library, and the ordinary General Public License treats it as such.

Because of this blurred distinction, using the ordinary General Public License for libraries did not effectively promote software sharing, because most developers did not use the libraries. We concluded that weaker conditions might promote sharing better.

However, unrestricted linking of non-free programs would deprive the users of those programs of all benefit from the free status of the libraries themselves. This Library General Public License is intended to permit developers of non-free programs to use free libraries, while preserving your freedom as a user of such programs to change the free libraries that are incorporated in them. (We have not seen how to achieve this as regards changes in header files, but we have achieved it as regards changes in the actual functions of the Library.) The hope is that this will lead to faster development of free libraries.

The precise terms and conditions for copying, distribution and modification follow. Pay close attention to the difference between a "work based on the library" and a "work that uses the library". The former contains code derived from the library, while the latter only

works together with the library.

Note that it is possible for a library to be covered by the ordinary General Public License rather than by this special one.

GNU LIBRARY GENERAL PUBLIC LICENSE
TERMS AND CONDITIONS FOR COPYING, DISTRIBUTION AND MODIFICATION

0. This License Agreement applies to any software library which contains a notice placed by the copyright holder or other authorized party saying it may be distributed under the terms of this Library General Public License (also called "this License"). Each licensee is addressed as "you".

A "library" means a collection of software functions and/or data prepared so as to be conveniently linked with application programs (which use some of those functions and data) to form executables.

The "Library", below, refers to any such software library or work which has been distributed under these terms. A "work based on the Library" means either the Library or any derivative work under copyright law: that is to say, a work containing the Library or a portion of it, either verbatim or with modifications and/or translated straightforwardly into another language. (Hereinafter, translation is included without limitation in the term "modification".)

"Source code" for a work means the preferred form of the work for making modifications to it. For a library, complete source code means all the source code for all modules it contains, plus any associated interface definition files, plus the scripts used to control compilation and installation of the library.

Activities other than copying, distribution and modification are not covered by this License; they are outside its scope. The act of running a program using the Library is not restricted, and output from such a program is covered only if its contents constitute a work based on the Library (independent of the use of the Library in a tool for writing it). Whether that is true depends on what the Library does and what the program that uses the Library does.

1. You may copy and distribute verbatim copies of the Library's complete source code as you receive it, in any medium, provided that you conspicuously and appropriately publish on each copy an appropriate copyright notice and disclaimer of warranty; keep intact all the notices that refer to this License and to the absence of any warranty; and distribute a copy of this License along with the Library.

You may charge a fee for the physical act of transferring a copy, and you may at your option offer warranty protection in exchange for a fee.

2. You may modify your copy or copies of the Library or any portion of it, thus forming a work based on the Library, and copy and distribute such modifications or work under the terms of Section 1 above, provided that you also meet all of these conditions:

- a) The modified work must itself be a software library.
- b) You must cause the files modified to carry prominent notices stating that you changed the files and the date of any change.
- c) You must cause the whole of the work to be licensed at no charge to all third parties under the terms of this License.
- d) If a facility in the modified Library refers to a function or a table of data to be supplied by an application program that uses the facility, other than as an argument passed when the facility is invoked, then you must make a good faith effort to ensure that, in the event an application does not supply such function or

table, the facility still operates, and performs whatever part of its purpose remains meaningful.

(For example, a function in a library to compute square roots has a purpose that is entirely well-defined independent of the application. Therefore, Subsection 2d requires that any application-supplied function or table used by this function must be optional: if the application does not supply it, the square root function must still compute square roots.)

These requirements apply to the modified work as a whole. If identifiable sections of that work are not derived from the Library, and can be reasonably considered independent and separate works in themselves, then this License, and its terms, do not apply to those sections when you distribute them as separate works. But when you distribute the same sections as part of a whole which is a work based on the Library, the distribution of the whole must be on the terms of this License, whose permissions for other licensees extend to the entire whole, and thus to each and every part regardless of who wrote it.

Thus, it is not the intent of this section to claim rights or contest your rights to work written entirely by you; rather, the intent is to exercise the right to control the distribution of derivative or collective works based on the Library.

In addition, mere aggregation of another work not based on the Library with the Library (or with a work based on the Library) on a volume of a storage or distribution medium does not bring the other work under the scope of this License.

3. You may opt to apply the terms of the ordinary GNU General Public License instead of this License to a given copy of the Library. To do this, you must alter all the notices that refer to this License, so that they refer to the ordinary GNU General Public License, version 2, instead of to this License. (If a newer version than version 2 of the ordinary GNU General Public License has appeared, then you can specify that version instead if you wish.) Do not make any other change in these notices.

Once this change is made in a given copy, it is irreversible for that copy, so the ordinary GNU General Public License applies to all subsequent copies and derivative works made from that copy.

This option is useful when you wish to copy part of the code of the Library into a program that is not a library.

4. You may copy and distribute the Library (or a portion or derivative of it, under Section 2) in object code or executable form under the terms of Sections 1 and 2 above provided that you accompany it with the complete corresponding machine-readable source code, which must be distributed under the terms of Sections 1 and 2 above on a medium customarily used for software interchange.

If distribution of object code is made by offering access to copy from a designated place, then offering equivalent access to copy the source code from the same place satisfies the requirement to distribute the source code, even though third parties are not compelled to copy the source along with the object code.

5. A program that contains no derivative of any portion of the Library, but is designed to work with the Library by being compiled or linked with it, is called a "work that uses the Library". Such a work, in isolation, is not a derivative work of the Library, and therefore falls outside the scope of this License.

However, linking a "work that uses the Library" with the Library creates an executable that is a derivative of the Library (because it contains portions of the Library), rather than a "work that uses the library". The executable is therefore covered by this License.

Section 6 states terms for distribution of such executables.

When a "work that uses the Library" uses material from a header file that is part of the Library, the object code for the work may be a derivative work of the Library even though the source code is not. Whether this is true is especially significant if the work can be linked without the Library, or if the work is itself a library. The threshold for this to be true is not precisely defined by law.

If such an object file uses only numerical parameters, data structure layouts and accessors, and small macros and small inline functions (ten lines or less in length), then the use of the object file is unrestricted, regardless of whether it is legally a derivative work. (Executables containing this object code plus portions of the Library will still fall under Section 6.)

Otherwise, if the work is a derivative of the Library, you may distribute the object code for the work under the terms of Section 6. Any executables containing that work also fall under Section 6, whether or not they are linked directly with the Library itself.

6. As an exception to the Sections above, you may also compile or link a "work that uses the Library" with the Library to produce a work containing portions of the Library, and distribute that work under terms of your choice, provided that the terms permit modification of the work for the customer's own use and reverse engineering for debugging such modifications.

You must give prominent notice with each copy of the work that the Library is used in it and that the Library and its use are covered by this License. You must supply a copy of this License. If the work during execution displays copyright notices, you must include the copyright notice for the Library among them, as well as a reference directing the user to the copy of this License. Also, you must do one of these things:

- a) Accompany the work with the complete corresponding machine-readable source code for the Library including whatever changes were used in the work (which must be distributed under Sections 1 and 2 above); and, if the work is an executable linked with the Library, with the complete machine-readable "work that uses the Library", as object code and/or source code, so that the user can modify the Library and then relink to produce a modified executable containing the modified Library. (It is understood that the user who changes the contents of definitions files in the Library will not necessarily be able to recompile the application to use the modified definitions.)
- b) Accompany the work with a written offer, valid for at least three years, to give the same user the materials specified in Subsection 6a, above, for a charge no more than the cost of performing this distribution.
- c) If distribution of the work is made by offering access to copy from a designated place, offer equivalent access to copy the above specified materials from the same place.
- d) Verify that the user has already received a copy of these materials or that you have already sent this user a copy.

For an executable, the required form of the "work that uses the Library" must include any data and utility programs needed for reproducing the executable from it. However, as a special exception, the source code distributed need not include anything that is normally distributed (in either source or binary form) with the major components (compiler, kernel, and so on) of the operating system on which the executable runs, unless that component itself accompanies the executable.

It may happen that this requirement contradicts the license

restrictions of other proprietary libraries that do not normally accompany the operating system. Such a contradiction means you cannot use both them and the Library together in an executable that you distribute.

7. You may place library facilities that are a work based on the Library side-by-side in a single library together with other library facilities not covered by this License, and distribute such a combined library, provided that the separate distribution of the work based on the Library and of the other library facilities is otherwise permitted, and provided that you do these two things:

- a) Accompany the combined library with a copy of the same work based on the Library, uncombined with any other library facilities. This must be distributed under the terms of the Sections above.
- b) Give prominent notice with the combined library of the fact that part of it is a work based on the Library, and explaining where to find the accompanying uncombined form of the same work.

8. You may not copy, modify, sublicense, link with, or distribute the Library except as expressly provided under this License. Any attempt otherwise to copy, modify, sublicense, link with, or distribute the Library is void, and will automatically terminate your rights under this License. However, parties who have received copies, or rights, from you under this License will not have their licenses terminated so long as such parties remain in full compliance.

9. You are not required to accept this License, since you have not signed it. However, nothing else grants you permission to modify or distribute the Library or its derivative works. These actions are prohibited by law if you do not accept this License. Therefore, by modifying or distributing the Library (or any work based on the Library), you indicate your acceptance of this License to do so, and all its terms and conditions for copying, distributing or modifying the Library or works based on it.

10. Each time you redistribute the Library (or any work based on the Library), the recipient automatically receives a license from the original licensor to copy, distribute, link with or modify the Library subject to these terms and conditions. You may not impose any further restrictions on the recipients' exercise of the rights granted herein. You are not responsible for enforcing compliance by third parties to this License.

11. If, as a consequence of a court judgment or allegation of patent infringement or for any other reason (not limited to patent issues), conditions are imposed on you (whether by court order, agreement or otherwise) that contradict the conditions of this License, they do not excuse you from the conditions of this License. If you cannot distribute so as to satisfy simultaneously your obligations under this License and any other pertinent obligations, then as a consequence you may not distribute the Library at all. For example, if a patent license would not permit royalty-free redistribution of the Library by all those who receive copies directly or indirectly through you, then the only way you could satisfy both it and this License would be to refrain entirely from distribution of the Library.

If any portion of this section is held invalid or unenforceable under any particular circumstance, the balance of the section is intended to apply, and the section as a whole is intended to apply in other circumstances.

It is not the purpose of this section to induce you to infringe any patents or other property right claims or to contest validity of any such claims; this section has the sole purpose of protecting the integrity of the free software distribution system which is implemented by public license practices. Many people have made generous contributions to the wide range of software distributed through that system in reliance on consistent application of that

system; it is up to the author/donor to decide if he or she is willing to distribute software through any other system and a licensee cannot impose that choice.

This section is intended to make thoroughly clear what is believed to be a consequence of the rest of this License.

12. If the distribution and/or use of the Library is restricted in certain countries either by patents or by copyrighted interfaces, the original copyright holder who places the Library under this License may add an explicit geographical distribution limitation excluding those countries, so that distribution is permitted only in or among countries not thus excluded. In such case, this License incorporates the limitation as if written in the body of this License.

13. The Free Software Foundation may publish revised and/or new versions of the Library General Public License from time to time. Such new versions will be similar in spirit to the present version, but may differ in detail to address new problems or concerns.

Each version is given a distinguishing version number. If the Library specifies a version number of this License which applies to it and "any later version", you have the option of following the terms and conditions either of that version or of any later version published by the Free Software Foundation. If the Library does not specify a license version number, you may choose any version ever published by the Free Software Foundation.

14. If you wish to incorporate parts of the Library into other free programs whose distribution conditions are incompatible with these, write to the author to ask for permission. For software which is copyrighted by the Free Software Foundation, write to the Free Software Foundation; we sometimes make exceptions for this. Our decision will be guided by the two goals of preserving the free status of all derivatives of our free software and of promoting the sharing and reuse of software generally.

NO WARRANTY

15. BECAUSE THE LIBRARY IS LICENSED FREE OF CHARGE, THERE IS NO WARRANTY FOR THE LIBRARY, TO THE EXTENT PERMITTED BY APPLICABLE LAW. EXCEPT WHEN OTHERWISE STATED IN WRITING THE COPYRIGHT HOLDERS AND/OR OTHER PARTIES PROVIDE THE LIBRARY "AS IS" WITHOUT WARRANTY OF ANY KIND, EITHER EXPRESSED OR IMPLIED, INCLUDING, BUT NOT LIMITED TO, THE IMPLIED WARRANTIES OF MERCHANTABILITY AND FITNESS FOR A PARTICULAR PURPOSE. THE ENTIRE RISK AS TO THE QUALITY AND PERFORMANCE OF THE LIBRARY IS WITH YOU. SHOULD THE LIBRARY PROVE DEFECTIVE, YOU ASSUME THE COST OF ALL NECESSARY SERVICING, REPAIR OR CORRECTION.

16. IN NO EVENT UNLESS REQUIRED BY APPLICABLE LAW OR AGREED TO IN WRITING WILL ANY COPYRIGHT HOLDER, OR ANY OTHER PARTY WHO MAY MODIFY AND/OR REDISTRIBUTE THE LIBRARY AS PERMITTED ABOVE, BE LIABLE TO YOU FOR DAMAGES, INCLUDING ANY GENERAL, SPECIAL, INCIDENTAL OR CONSEQUENTIAL DAMAGES ARISING OUT OF THE USE OR INABILITY TO USE THE LIBRARY (INCLUDING BUT NOT LIMITED TO LOSS OF DATA OR DATA BEING RENDERED INACCURATE OR LOSSES SUSTAINED BY YOU OR THIRD PARTIES OR A FAILURE OF THE LIBRARY TO OPERATE WITH ANY OTHER SOFTWARE), EVEN IF SUCH HOLDER OR OTHER PARTY HAS BEEN ADVISED OF THE POSSIBILITY OF SUCH DAMAGES.

END OF TERMS AND CONDITIONS

Appendix: How to Apply These Terms to Your New Libraries

If you develop a new library, and you want it to be of the greatest possible use to the public, we recommend making it free software that everyone can redistribute and change. You can do so by permitting redistribution under these terms (or, alternatively, under the terms of the ordinary General Public License).

To apply these terms, attach the following notices to the library. It is safest to attach them to the start of each source file to most effectively convey the exclusion of warranty; and each file should have at least the "copyright" line and a pointer to where the full notice is found.

```
<one line to give the library's name and a brief idea of what it does.>
Copyright (C) <year> <name of author>
```

```
This library is free software; you can redistribute it and/or
modify it under the terms of the GNU Library General Public
License as published by the Free Software Foundation; either
version 2 of the License, or (at your option) any later version.
```

```
This library is distributed in the hope that it will be useful,
but WITHOUT ANY WARRANTY; without even the implied warranty of
MERCHANTABILITY or FITNESS FOR A PARTICULAR PURPOSE. See the GNU
Library General Public License for more details.
```

```
You should have received a copy of the GNU Library General Public
License along with this library; if not, write to the Free
Software Foundation, Inc., 51 Franklin Street, Fifth Floor, Boston,
MA 02110-1301, USA
```

Also add information on how to contact you by electronic and paper mail.

You should also get your employer (if you work as a programmer) or your school, if any, to sign a "copyright disclaimer" for the library, if necessary. Here is a sample; alter the names:

```
Yoyodyne, Inc., hereby disclaims all copyright interest in the
library `Frob' (a library for tweaking knobs) written by James Random Hacker.
```

```
<signature of Ty Coon>, 1 April 1990
Ty Coon, President of Vice
```

That's all there is to it!

Libjpeg-turbo

libjpeg-turbo Licenses =====

libjpeg-turbo is covered by three compatible BSD-style open source licenses:

- The IJG (Independent JPEG Group) License, which is listed in [README.ijg] (README.ijg)

```
This license applies to the libjpeg API library and associated programs
(any code inherited from libjpeg, and any modifications to that code.)
```

- The Modified (3-clause) BSD License, which is listed below

```
This license covers the TurboJPEG API library and associated programs, as
well as the build system.
```

- The [zlib License] (<https://opensource.org/licenses/Zlib>)

```
This license is a subset of the other two, and it covers the libjpeg-turbo
SIMD extensions.
```

Complying with the libjpeg-turbo Licenses =====

This section provides a roll-up of the libjpeg-turbo licensing terms, to the best of our understanding.

1. If you are distributing a modified version of the libjpeg-turbo source, then:

1. You cannot alter or remove any existing copyright or license notices from the source.

```

**Origin**
- Clause 1 of the IJG License
- Clause 1 of the Modified BSD License
- Clauses 1 and 3 of the zlib License

```

2. You must add your own copyright notice to the header of each source file you modified, so others can tell that you modified that file (if there is not an existing copyright header in that file, then you can simply add a notice stating that you modified the file.)

```

**Origin**
- Clause 1 of the IJG License
- Clause 2 of the zlib License

```

3. You must include the IJG README file, and you must not alter any of the copyright or license text in that file.

```

**Origin**
- Clause 1 of the IJG License

```

2. If you are distributing only libjpeg-turbo binaries without the source, or if you are distributing an application that statically links with libjpeg-turbo, then:

1. Your product documentation must include a message stating:

```

This software is based in part on the work of the Independent JPEG
Group.

```

```

**Origin**
- Clause 2 of the IJG license

```

2. If your binary distribution includes or uses the TurboJPEG API, then your product documentation must include the text of the Modified BSD License (see below.)

```

**Origin**
- Clause 2 of the Modified BSD License

```

3. You cannot use the name of the IJG or The libjpeg-turbo Project or the contributors thereof in advertising, publicity, etc.

```

**Origin**
- IJG License
- Clause 3 of the Modified BSD License

```

4. The IJG and The libjpeg-turbo Project do not warrant libjpeg-turbo to be free of defects, nor do we accept any liability for undesirable consequences resulting from your use of the software.

```

**Origin**
- IJG License
- Modified BSD License
- zlib License

```

The Modified (3-clause) BSD License
 =====

Copyright (C)2009-2022 D. R. Commander. All Rights Reserved.
 Copyright (C)2015 Viktor Szathmáry. All Rights Reserved.

Redistribution and use in source and binary forms, with or without modification, are permitted provided that the following conditions are met:

- Redistributions of source code must retain the above copyright notice,

- this list of conditions and the following disclaimer.
- Redistributions in binary form must reproduce the above copyright notice, this list of conditions and the following disclaimer in the documentation and/or other materials provided with the distribution.
 - Neither the name of the libjpeg-turbo Project nor the names of its contributors may be used to endorse or promote products derived from this software without specific prior written permission.

THIS SOFTWARE IS PROVIDED BY THE COPYRIGHT HOLDERS AND CONTRIBUTORS "AS IS", AND ANY EXPRESS OR IMPLIED WARRANTIES, INCLUDING, BUT NOT LIMITED TO, THE IMPLIED WARRANTIES OF MERCHANTABILITY AND FITNESS FOR A PARTICULAR PURPOSE ARE DISCLAIMED. IN NO EVENT SHALL THE COPYRIGHT HOLDERS OR CONTRIBUTORS BE LIABLE FOR ANY DIRECT, INDIRECT, INCIDENTAL, SPECIAL, EXEMPLARY, OR CONSEQUENTIAL DAMAGES (INCLUDING, BUT NOT LIMITED TO, PROCUREMENT OF SUBSTITUTE GOODS OR SERVICES; LOSS OF USE, DATA, OR PROFITS; OR BUSINESS INTERRUPTION) HOWEVER CAUSED AND ON ANY THEORY OF LIABILITY, WHETHER IN CONTRACT, STRICT LIABILITY, OR TORT (INCLUDING NEGLIGENCE OR OTHERWISE) ARISING IN ANY WAY OUT OF THE USE OF THIS SOFTWARE, EVEN IF ADVISED OF THE POSSIBILITY OF SUCH DAMAGE.

Why Three Licenses?

=====

The zlib License could have been used instead of the Modified (3-clause) BSD License, and since the IJG License effectively subsumes the distribution conditions of the zlib License, this would have effectively placed libjpeg-turbo binary distributions under the IJG License. However, the IJG License specifically refers to the Independent JPEG Group and does not extend attribution and endorsement protections to other entities. Thus, it was desirable to choose a license that granted us the same protections for new code that were granted to the IJG for code derived from their software.

Liblzma

XZ Utils Licensing

=====

Different licenses apply to different files in this package. Here is a rough summary of which licenses apply to which parts of this package (but check the individual files to be sure!):

- liblzma is in the public domain.
- xz, xzdec, and lzmadec command line tools are in the public domain unless GNU getopt_long had to be compiled and linked in from the lib directory. The getopt_long code is under GNU LGPLv2.1+.
- The scripts to grep, diff, and view compressed files have been adapted from gzip. These scripts and their documentation are under GNU GPLv2+.
- All the documentation in the doc directory and most of the XZ Utils specific documentation files in other directories are in the public domain.
- Translated messages are in the public domain.
- The build system contains public domain files, and files that are under GNU GPLv2+ or GNU GPLv3+. None of these files end up in the binaries being built.
- Test files and test code in the tests directory, and debugging utilities in the debug directory are in the public domain.
- The extra directory may contain public domain files, and files that are under various free software licenses.

You can do whatever you want with the files that have been put into the public domain. If you find public domain legally problematic, take the previous sentence as a license grant. If you still find the lack of copyright legally problematic, you have too many lawyers.

As usual, this software is provided "as is", without any warranty.

If you copy significant amounts of public domain code from XZ Utils into your project, acknowledging this somewhere in your software is polite (especially if it is proprietary, non-free software), but naturally it is not legally required. Here is an example of a good notice to put into "about box" or into documentation:

This software includes code from XZ Utils <<https://tukaani.org/xz/>>.

The following license texts are included in the following files:

- COPYING.LGPLv2.1: GNU Lesser General Public License version 2.1
- COPYING.GPLv2: GNU General Public License version 2
- COPYING.GPLv3: GNU General Public License version 3

Note that the toolchain (compiler, linker etc.) may add some code pieces that are copyrighted. Thus, it is possible that e.g. liblzma binary wouldn't actually be in the public domain in its entirety even though it contains no copyrighted code from the XZ Utils source package.

If you have questions, don't hesitate to ask the author(s) for more information.

Libogg

Copyright (c) 2002, Xiph.org Foundation

Redistribution and use in source and binary forms, with or without modification, are permitted provided that the following conditions are met:

- Redistributions of source code must retain the above copyright notice, this list of conditions and the following disclaimer.
- Redistributions in binary form must reproduce the above copyright notice, this list of conditions and the following disclaimer in the documentation and/or other materials provided with the distribution.
- Neither the name of the Xiph.org Foundation nor the names of its contributors may be used to endorse or promote products derived from this software without specific prior written permission.

THIS SOFTWARE IS PROVIDED BY THE COPYRIGHT HOLDERS AND CONTRIBUTORS ``AS IS'' AND ANY EXPRESS OR IMPLIED WARRANTIES, INCLUDING, BUT NOT LIMITED TO, THE IMPLIED WARRANTIES OF MERCHANTABILITY AND FITNESS FOR A PARTICULAR PURPOSE ARE DISCLAIMED. IN NO EVENT SHALL THE FOUNDATION OR CONTRIBUTORS BE LIABLE FOR ANY DIRECT, INDIRECT, INCIDENTAL, SPECIAL, EXEMPLARY, OR CONSEQUENTIAL DAMAGES (INCLUDING, BUT NOT LIMITED TO, PROCUREMENT OF SUBSTITUTE GOODS OR SERVICES; LOSS OF USE, DATA, OR PROFITS; OR BUSINESS INTERRUPTION) HOWEVER CAUSED AND ON ANY THEORY OF LIABILITY, WHETHER IN CONTRACT, STRICT LIABILITY, OR TORT (INCLUDING NEGLIGENCE OR OTHERWISE) ARISING IN ANY WAY OUT OF THE USE OF THIS SOFTWARE, EVEN IF ADVISED OF THE POSSIBILITY OF SUCH DAMAGE.

Libpng

COPYRIGHT NOTICE, DISCLAIMER, and LICENSE
=====

PNG Reference Library License version 2

-
- * Copyright (c) 1995-2019 The PNG Reference Library Authors.
 - * Copyright (c) 2018-2019 Cosmin Truta.
 - * Copyright (c) 2000-2002, 2004, 2006-2018 Glenn Randers-Pehrson.
 - * Copyright (c) 1996-1997 Andreas Dilger.
 - * Copyright (c) 1995-1996 Guy Eric Schalnat, Group 42, Inc.

The software is supplied "as is", without warranty of any kind, express or implied, including, without limitation, the warranties of merchantability, fitness for a particular purpose, title, and non-infringement. In no event shall the Copyright owners, or anyone distributing the software, be liable for any damages or other liability, whether in contract, tort or otherwise, arising from, out of, or in connection with the software, or the use or other dealings in the software, even if advised of the possibility of such damage.

Permission is hereby granted to use, copy, modify, and distribute this software, or portions hereof, for any purpose, without fee, subject to the following restrictions:

1. The origin of this software must not be misrepresented; you must not claim that you wrote the original software. If you use this software in a product, an acknowledgment in the product documentation would be appreciated, but is not required.
2. Altered source versions must be plainly marked as such, and must not be misrepresented as being the original software.
3. This Copyright notice may not be removed or altered from any source or altered source distribution.

PNG Reference Library License version 1 (for libpng 0.5 through 1.6.35)

libpng versions 1.0.7, July 1, 2000, through 1.6.35, July 15, 2018 are Copyright (c) 2000-2002, 2004, 2006-2018 Glenn Randers-Pehrson, are derived from libpng-1.0.6, and are distributed according to the same disclaimer and license as libpng-1.0.6 with the following individuals added to the list of Contributing Authors:

Simon-Pierre Cadieux
 Eric S. Raymond
 Mans Rullgard
 Cosmin Truta
 Gilles Vollant
 James Yu
 Mandar Sahastrabudhe
 Google Inc.
 Vadim Barkov

and with the following additions to the disclaimer:

There is no warranty against interference with your enjoyment of the library or against infringement. There is no warranty that our efforts or the library will fulfill any of your particular purposes or needs. This library is provided with all faults, and the entire risk of satisfactory quality, performance, accuracy, and effort is with the user.

Some files in the "contrib" directory and some configure-generated files that are distributed with libpng have other copyright owners, and are released under other open source licenses.

libpng versions 0.97, January 1998, through 1.0.6, March 20, 2000, are Copyright (c) 1998-2000 Glenn Randers-Pehrson, are derived from libpng-0.96, and are distributed according to the same disclaimer and license as libpng-0.96, with the following individuals added to the

list of Contributing Authors:

Tom Lane
Glenn Randers-Pehrson
Willem van Schaik

libpng versions 0.89, June 1996, through 0.96, May 1997, are Copyright (c) 1996-1997 Andreas Dilger, are derived from libpng-0.88, and are distributed according to the same disclaimer and license as libpng-0.88, with the following individuals added to the list of Contributing Authors:

John Bowler
Kevin Bracey
Sam Bushell
Magnus Holmgren
Greg Roelofs
Tom Tanner

Some files in the "scripts" directory have other copyright owners, but are released under this license.

libpng versions 0.5, May 1995, through 0.88, January 1996, are Copyright (c) 1995-1996 Guy Eric Schalnat, Group 42, Inc.

For the purposes of this copyright and license, "Contributing Authors" is defined as the following set of individuals:

Andreas Dilger
Dave Martindale
Guy Eric Schalnat
Paul Schmidt
Tim Wegner

The PNG Reference Library is supplied "AS IS". The Contributing Authors and Group 42, Inc. disclaim all warranties, expressed or implied, including, without limitation, the warranties of merchantability and of fitness for any purpose. The Contributing Authors and Group 42, Inc. assume no liability for direct, indirect, incidental, special, exemplary, or consequential damages, which may result from the use of the PNG Reference Library, even if advised of the possibility of such damage.

Permission is hereby granted to use, copy, modify, and distribute this source code, or portions hereof, for any purpose, without fee, subject to the following restrictions:

1. The origin of this source code must not be misrepresented.
2. Altered versions must be plainly marked as such and must not be misrepresented as being the original source.
3. This Copyright notice may not be removed or altered from any source or altered source distribution.

The Contributing Authors and Group 42, Inc. specifically permit, without fee, and encourage the use of this source code as a component to supporting the PNG file format in commercial products. If you use this source code in a product, acknowledgment is not required but would be appreciated.

Libtheora

Copyright (C) 2002-2009 Xiph.org Foundation

Redistribution and use in source and binary forms, with or without modification, are permitted provided that the following conditions are met:

- Redistributions of source code must retain the above copyright notice, this list of conditions and the following disclaimer.

- Redistributions in binary form must reproduce the above copyright notice, this list of conditions and the following disclaimer in the documentation and/or other materials provided with the distribution.

- Neither the name of the Xiph.org Foundation nor the names of its contributors may be used to endorse or promote products derived from this software without specific prior written permission.

THIS SOFTWARE IS PROVIDED BY THE COPYRIGHT HOLDERS AND CONTRIBUTORS ``AS IS'' AND ANY EXPRESS OR IMPLIED WARRANTIES, INCLUDING, BUT NOT LIMITED TO, THE IMPLIED WARRANTIES OF MERCHANTABILITY AND FITNESS FOR A PARTICULAR PURPOSE ARE DISCLAIMED. IN NO EVENT SHALL THE FOUNDATION OR CONTRIBUTORS BE LIABLE FOR ANY DIRECT, INDIRECT, INCIDENTAL, SPECIAL, EXEMPLARY, OR CONSEQUENTIAL DAMAGES (INCLUDING, BUT NOT LIMITED TO, PROCUREMENT OF SUBSTITUTE GOODS OR SERVICES; LOSS OF USE, DATA, OR PROFITS; OR BUSINESS INTERRUPTION) HOWEVER CAUSED AND ON ANY THEORY OF LIABILITY, WHETHER IN CONTRACT, STRICT LIABILITY, OR TORT (INCLUDING NEGLIGENCE OR OTHERWISE) ARISING IN ANY WAY OUT OF THE USE OF THIS SOFTWARE, EVEN IF ADVISED OF THE POSSIBILITY OF SUCH DAMAGE.

Libxml2

Except where otherwise noted in the source code (e.g. the files hash.c, list.c and the trio files, which are covered by a similar licence but with different Copyright notices) all the files are:

Copyright (C) 1998-2012 Daniel Veillard. All Rights Reserved.

Permission is hereby granted, free of charge, to any person obtaining a copy of this software and associated documentation files (the "Software"), to deal in the Software without restriction, including without limitation the rights to use, copy, modify, merge, publish, distribute, sublicense, and/or sell copies of the Software, and to permit persons to whom the Software is furnished to do so, subject to the following conditions:

The above copyright notice and this permission notice shall be included in all copies or substantial portions of the Software.

THE SOFTWARE IS PROVIDED "AS IS", WITHOUT WARRANTY OF ANY KIND, EXPRESS OR IMPLIED, INCLUDING BUT NOT LIMITED TO THE WARRANTIES OF MERCHANTABILITY, FITNESS FOR A PARTICULAR PURPOSE AND NONINFRINGEMENT. IN NO EVENT SHALL THE AUTHORS OR COPYRIGHT HOLDERS BE LIABLE FOR ANY CLAIM, DAMAGES OR OTHER LIABILITY, WHETHER IN AN ACTION OF CONTRACT, TORT OR OTHERWISE, ARISING FROM, OUT OF OR IN CONNECTION WITH THE SOFTWARE OR THE USE OR OTHER DEALINGS IN THE SOFTWARE.

Lz4

LZ4 Library
Copyright (c) 2011-2016, Yann Collet
All rights reserved.

Redistribution and use in source and binary forms, with or without modification, are permitted provided that the following conditions are met:

* Redistributions of source code must retain the above copyright notice, this list of conditions and the following disclaimer.

* Redistributions in binary form must reproduce the above copyright notice, this list of conditions and the following disclaimer in the documentation and/or other materials provided with the distribution.

THIS SOFTWARE IS PROVIDED BY THE COPYRIGHT HOLDERS AND CONTRIBUTORS "AS IS" AND ANY EXPRESS OR IMPLIED WARRANTIES, INCLUDING, BUT NOT LIMITED TO, THE IMPLIED

WARRANTIES OF MERCHANTABILITY AND FITNESS FOR A PARTICULAR PURPOSE ARE DISCLAIMED. IN NO EVENT SHALL THE COPYRIGHT HOLDER OR CONTRIBUTORS BE LIABLE FOR ANY DIRECT, INDIRECT, INCIDENTAL, SPECIAL, EXEMPLARY, OR CONSEQUENTIAL DAMAGES (INCLUDING, BUT NOT LIMITED TO, PROCUREMENT OF SUBSTITUTE GOODS OR SERVICES; LOSS OF USE, DATA, OR PROFITS; OR BUSINESS INTERRUPTION) HOWEVER CAUSED AND ON ANY THEORY OF LIABILITY, WHETHER IN CONTRACT, STRICT LIABILITY, OR TORT (INCLUDING NEGLIGENCE OR OTHERWISE) ARISING IN ANY WAY OUT OF THE USE OF THIS SOFTWARE, EVEN IF ADVISED OF THE POSSIBILITY OF SUCH DAMAGE.

Netcdf-c

Copyright 2018 Unidata

Redistribution and use in source and binary forms, with or without modification, are permitted provided that the following conditions are met:

1. Redistributions of source code must retain the above copyright notice, this list of conditions and the following disclaimer.
2. Redistributions in binary form must reproduce the above copyright notice, this list of conditions and the following disclaimer in the documentation and/or other materials provided with the distribution.
3. Neither the name of the copyright holder nor the names of its contributors may be used to endorse or promote products derived from this software without specific prior written permission.

THIS SOFTWARE IS PROVIDED BY THE COPYRIGHT HOLDERS AND CONTRIBUTORS "AS IS" AND ANY EXPRESS OR IMPLIED WARRANTIES, INCLUDING THE IMPLIED WARRANTIES OF MERCHANTABILITY AND FITNESS FOR A PARTICULAR PURPOSE ARE DISCLAIMED.

Nlohmann-json

MIT License

Copyright (c) 2013-2022 Niels Lohmann

Permission is hereby granted, free of charge, to any person obtaining a copy of this software and associated documentation files (the "Software"), to deal in the Software without restriction, including without limitation the rights to use, copy, modify, merge, publish, distribute, sublicense, and/or sell copies of the Software, and to permit persons to whom the Software is furnished to do so, subject to the following conditions:

The above copyright notice and this permission notice shall be included in all copies or substantial portions of the Software.

THE SOFTWARE IS PROVIDED "AS IS", WITHOUT WARRANTY OF ANY KIND, EXPRESS OR IMPLIED, INCLUDING BUT NOT LIMITED TO THE WARRANTIES OF MERCHANTABILITY, FITNESS FOR A PARTICULAR PURPOSE AND NONINFRINGEMENT. IN NO EVENT SHALL THE AUTHORS OR COPYRIGHT HOLDERS BE LIABLE FOR ANY CLAIM, DAMAGES OR OTHER LIABILITY, WHETHER IN AN ACTION OF CONTRACT, TORT OR OTHERWISE, ARISING FROM, OUT OF OR IN CONNECTION WITH THE SOFTWARE OR THE USE OR OTHER DEALINGS IN THE SOFTWARE.

Op2

BSD 2-Clause License - <http://www.opensource.org/licenses/bsd-license.php>

This file is part of the OP2 distribution.

Copyright (c) 2011, Gihan Mudalige, Istvan Reguly, Mike Giles, and others. Please see the AUTHORS file in the main source directory for details. All rights reserved.

Redistribution and use in source and binary forms, with or without modification, are permitted provided that the following conditions are met:

- * Redistributions of source code must retain the above copyright notice, this list of conditions and the following disclaimer.
- * Redistributions in binary form must reproduce the above copyright notice, this list of conditions and the following disclaimer in the documentation and/or other materials provided with the distribution.
- * The name of Mike Giles may not be used to endorse or promote products derived from this software without specific prior written permission.

derived from this software without specific prior written permission.

THIS SOFTWARE IS PROVIDED BY THE COPYRIGHT HOLDERS AND CONTRIBUTORS "AS IS" AND ANY EXPRESS OR IMPLIED WARRANTIES, INCLUDING, BUT NOT LIMITED TO, THE IMPLIED WARRANTIES OF MERCHANTABILITY AND FITNESS FOR A PARTICULAR PURPOSE ARE DISCLAIMED. IN NO EVENT SHALL THE COPYRIGHT HOLDER OR CONTRIBUTORS BE LIABLE FOR ANY DIRECT, INDIRECT, INCIDENTAL, SPECIAL, EXEMPLARY, OR CONSEQUENTIAL DAMAGES (INCLUDING, BUT NOT LIMITED TO, PROCUREMENT OF SUBSTITUTE GOODS OR SERVICES; LOSS OF USE, DATA, OR PROFITS; OR BUSINESS INTERRUPTION) HOWEVER CAUSED AND ON ANY THEORY OF LIABILITY, WHETHER IN CONTRACT, STRICT LIABILITY, OR TORT (INCLUDING NEGLIGENCE OR OTHERWISE) ARISING IN ANY WAY OUT OF THE USE OF THIS SOFTWARE, EVEN IF ADVISED OF THE POSSIBILITY OF SUCH DAMAGE.

OpenMesh

OpenMesh is licensed under the 3-clause BSD License. See the LICENSE file for the complete license.

```

/* ===== *
 *                                     *
 *                               OpenMesh *
 *      Copyright (c) 2001-2015, RWTH-Aachen University *
 *      Department of Computer Graphics and Multimedia *
 *                               All rights reserved. *
 *                               www.openmesh.org *
 *                                     *
 *-----*
 * This file is part of OpenMesh. *
 *-----*
 *                                     *
 * Redistribution and use in source and binary forms, with or without *
 * modification, are permitted provided that the following conditions *
 * are met: *
 * *                                     *
 * 1. Redistributions of source code must retain the above copyright notice, *
 *   this list of conditions and the following disclaimer. *
 * *                                     *
 * 2. Redistributions in binary form must reproduce the above copyright *
 *   notice, this list of conditions and the following disclaimer in the *
 *   documentation and/or other materials provided with the distribution. *
 * *                                     *
 * 3. Neither the name of the copyright holder nor the names of its *
 *   contributors may be used to endorse or promote products derived from *
 *   this software without specific prior written permission. *
 * *                                     *
 * THIS SOFTWARE IS PROVIDED BY THE COPYRIGHT HOLDERS AND CONTRIBUTORS *
 * "AS IS" AND ANY EXPRESS OR IMPLIED WARRANTIES, INCLUDING, BUT NOT LIMITED *
 * TO, THE IMPLIED WARRANTIES OF MERCHANTABILITY AND FITNESS FOR A *
 * PARTICULAR PURPOSE ARE DISCLAIMED. IN NO EVENT SHALL THE COPYRIGHT HOLDER *
 * OR CONTRIBUTORS BE LIABLE FOR ANY DIRECT, INDIRECT, INCIDENTAL, SPECIAL, *
 * EXEMPLARY, OR CONSEQUENTIAL DAMAGES (INCLUDING, BUT NOT LIMITED TO, *
 * PROCUREMENT OF SUBSTITUTE GOODS OR SERVICES; LOSS OF USE, DATA, OR *
 * PROFITS; OR BUSINESS INTERRUPTION) HOWEVER CAUSED AND ON ANY THEORY OF *
 * LIABILITY, WHETHER IN CONTRACT, STRICT LIABILITY, OR TORT (INCLUDING *
 * NEGLIGENCE OR OTHERWISE) ARISING IN ANY WAY OUT OF THE USE OF THIS *
 * SOFTWARE, EVEN IF ADVISED OF THE POSSIBILITY OF SUCH DAMAGE. *
 * *                                     *
 * ===== *\

```

Openssl

Apache License

Version 2.0, January 2004
<https://www.apache.org/licenses/>

TERMS AND CONDITIONS FOR USE, REPRODUCTION, AND DISTRIBUTION

1. Definitions.

"License" shall mean the terms and conditions for use, reproduction, and distribution as defined by Sections 1 through 9 of this document.

"Licensor" shall mean the copyright owner or entity authorized by the copyright owner that is granting the License.

"Legal Entity" shall mean the union of the acting entity and all other entities that control, are controlled by, or are under common control with that entity. For the purposes of this definition, "control" means (i) the power, direct or indirect, to cause the direction or management of such entity, whether by contract or otherwise, or (ii) ownership of fifty percent (50%) or more of the outstanding shares, or (iii) beneficial ownership of such entity.

"You" (or "Your") shall mean an individual or Legal Entity exercising permissions granted by this License.

"Source" form shall mean the preferred form for making modifications, including but not limited to software source code, documentation source, and configuration files.

"Object" form shall mean any form resulting from mechanical transformation or translation of a Source form, including but not limited to compiled object code, generated documentation, and conversions to other media types.

"Work" shall mean the work of authorship, whether in Source or Object form, made available under the License, as indicated by a copyright notice that is included in or attached to the work (an example is provided in the Appendix below).

"Derivative Works" shall mean any work, whether in Source or Object form, that is based on (or derived from) the Work and for which the editorial revisions, annotations, elaborations, or other modifications represent, as a whole, an original work of authorship. For the purposes of this License, Derivative Works shall not include works that remain separable from, or merely link (or bind by name) to the interfaces of, the Work and Derivative Works thereof.

"Contribution" shall mean any work of authorship, including the original version of the Work and any modifications or additions to that Work or Derivative Works thereof, that is intentionally submitted to Licensor for inclusion in the Work by the copyright owner or by an individual or Legal Entity authorized to submit on behalf of the copyright owner. For the purposes of this definition, "submitted" means any form of electronic, verbal, or written communication sent to the Licensor or its representatives, including but not limited to communication on electronic mailing lists, source code control systems, and issue tracking systems that are managed by, or on behalf of, the Licensor for the purpose of discussing and improving the Work, but excluding communication that is conspicuously marked or otherwise designated in writing by the copyright owner as "Not a Contribution."

"Contributor" shall mean Licensor and any individual or Legal Entity on behalf of whom a Contribution has been received by Licensor and subsequently incorporated within the Work.

2. Grant of Copyright License. Subject to the terms and conditions of this License, each Contributor hereby grants to You a perpetual, worldwide, non-exclusive, no-charge, royalty-free, irrevocable copyright license to reproduce, prepare Derivative Works of, publicly display, publicly perform, sublicense, and distribute the Work and such Derivative Works in Source or Object form.
3. Grant of Patent License. Subject to the terms and conditions of this License, each Contributor hereby grants to You a perpetual, worldwide, non-exclusive, no-charge, royalty-free, irrevocable (except as stated in this section) patent license to make, have made, use, offer to sell, sell, import, and otherwise transfer the Work,

where such license applies only to those patent claims licensable by such Contributor that are necessarily infringed by their Contribution(s) alone or by combination of their Contribution(s) with the Work to which such Contribution(s) was submitted. If You institute patent litigation against any entity (including a cross-claim or counterclaim in a lawsuit) alleging that the Work or a Contribution incorporated within the Work constitutes direct or contributory patent infringement, then any patent licenses granted to You under this License for that Work shall terminate as of the date such litigation is filed.

4. Redistribution. You may reproduce and distribute copies of the Work or Derivative Works thereof in any medium, with or without modifications, and in Source or Object form, provided that You meet the following conditions:
 - (a) You must give any other recipients of the Work or Derivative Works a copy of this License; and
 - (b) You must cause any modified files to carry prominent notices stating that You changed the files; and
 - (c) You must retain, in the Source form of any Derivative Works that You distribute, all copyright, patent, trademark, and attribution notices from the Source form of the Work, excluding those notices that do not pertain to any part of the Derivative Works; and
 - (d) If the Work includes a "NOTICE" text file as part of its distribution, then any Derivative Works that You distribute must include a readable copy of the attribution notices contained within such NOTICE file, excluding those notices that do not pertain to any part of the Derivative Works, in at least one of the following places: within a NOTICE text file distributed as part of the Derivative Works; within the Source form or documentation, if provided along with the Derivative Works; or, within a display generated by the Derivative Works, if and wherever such third-party notices normally appear. The contents of the NOTICE file are for informational purposes only and do not modify the License. You may add Your own attribution notices within Derivative Works that You distribute, alongside or as an addendum to the NOTICE text from the Work, provided that such additional attribution notices cannot be construed as modifying the License.

You may add Your own copyright statement to Your modifications and may provide additional or different license terms and conditions for use, reproduction, or distribution of Your modifications, or for any such Derivative Works as a whole, provided Your use, reproduction, and distribution of the Work otherwise complies with the conditions stated in this License.

5. Submission of Contributions. Unless You explicitly state otherwise, any Contribution intentionally submitted for inclusion in the Work by You to the Licensor shall be under the terms and conditions of this License, without any additional terms or conditions. Notwithstanding the above, nothing herein shall supersede or modify the terms of any separate license agreement you may have executed with Licensor regarding such Contributions.
6. Trademarks. This License does not grant permission to use the trade names, trademarks, service marks, or product names of the Licensor, except as required for reasonable and customary use in describing the origin of the Work and reproducing the content of the NOTICE file.
7. Disclaimer of Warranty. Unless required by applicable law or agreed to in writing, Licensor provides the Work (and each Contributor provides its Contributions) on an "AS IS" BASIS, WITHOUT WARRANTIES OR CONDITIONS OF ANY KIND, either express or implied, including, without limitation, any warranties or conditions

of TITLE, NON-INFRINGEMENT, MERCHANTABILITY, or FITNESS FOR A PARTICULAR PURPOSE. You are solely responsible for determining the appropriateness of using or redistributing the Work and assume any risks associated with Your exercise of permissions under this License.

8. Limitation of Liability. In no event and under no legal theory, whether in tort (including negligence), contract, or otherwise, unless required by applicable law (such as deliberate and grossly negligent acts) or agreed to in writing, shall any Contributor be liable to You for damages, including any direct, indirect, special, incidental, or consequential damages of any character arising as a result of this License or out of the use or inability to use the Work (including but not limited to damages for loss of goodwill, work stoppage, computer failure or malfunction, or any and all other commercial damages or losses), even if such Contributor has been advised of the possibility of such damages.
9. Accepting Warranty or Additional Liability. While redistributing the Work or Derivative Works thereof, You may choose to offer, and charge a fee for, acceptance of support, warranty, indemnity, or other liability obligations and/or rights consistent with this License. However, in accepting such obligations, You may act only on Your own behalf and on Your sole responsibility, not on behalf of any other Contributor, and only if You agree to indemnify, defend, and hold each Contributor harmless for any liability incurred by, or claims asserted against, such Contributor by reason of your accepting any such warranty or additional liability.

END OF TERMS AND CONDITIONS

Pcre2

PCRE2 LICENCE

PCRE2 is a library of functions to support regular expressions whose syntax and semantics are as close as possible to those of the Perl 5 language.

Releases 10.00 and above of PCRE2 are distributed under the terms of the "BSD" licence, as specified below, with one exemption for certain binary redistributions. The documentation for PCRE2, supplied in the "doc" directory, is distributed under the same terms as the software itself. The data in the testdata directory is not copyrighted and is in the public domain.

The basic library functions are written in C and are freestanding. Also included in the distribution is a just-in-time compiler that can be used to optimize pattern matching. This is an optional feature that can be omitted when the library is built.

THE BASIC LIBRARY FUNCTIONS

Written by: Philip Hazel
Email local part: Philip.Hazel
Email domain: gmail.com

Retired from University of Cambridge Computing Service,
Cambridge, England.

Copyright (c) 1997-2021 University of Cambridge
All rights reserved.

PCRE2 JUST-IN-TIME COMPILATION SUPPORT

Written by: Zoltan Herczeg
Email local part: hzmester

Email domain: freemail.hu

Copyright(c) 2010-2021 Zoltan Herczeg
All rights reserved.

STACK-LESS JUST-IN-TIME COMPILER

Written by: Zoltan Herczeg
Email local part: hzmester
Email domain: freemail.hu

Copyright(c) 2009-2021 Zoltan Herczeg
All rights reserved.

THE "BSD" LICENCE

Redistribution and use in source and binary forms, with or without
modification, are permitted provided that the following conditions are met:

- * Redistributions of source code must retain the above copyright notices,
this list of conditions and the following disclaimer.
- * Redistributions in binary form must reproduce the above copyright
notices, this list of conditions and the following disclaimer in the
documentation and/or other materials provided with the distribution.
- * Neither the name of the University of Cambridge nor the names of any
contributors may be used to endorse or promote products derived from this
software without specific prior written permission.

THIS SOFTWARE IS PROVIDED BY THE COPYRIGHT HOLDERS AND CONTRIBUTORS "AS IS"
AND ANY EXPRESS OR IMPLIED WARRANTIES, INCLUDING, BUT NOT LIMITED TO, THE
IMPLIED WARRANTIES OF MERCHANTABILITY AND FITNESS FOR A PARTICULAR PURPOSE
ARE DISCLAIMED. IN NO EVENT SHALL THE COPYRIGHT OWNER OR CONTRIBUTORS BE
LIABLE FOR ANY DIRECT, INDIRECT, INCIDENTAL, SPECIAL, EXEMPLARY, OR
CONSEQUENTIAL DAMAGES (INCLUDING, BUT NOT LIMITED TO, PROCUREMENT OF
SUBSTITUTE GOODS OR SERVICES; LOSS OF USE, DATA, OR PROFITS; OR BUSINESS
INTERRUPTION) HOWEVER CAUSED AND ON ANY THEORY OF LIABILITY, WHETHER IN
CONTRACT, STRICT LIABILITY, OR TORT (INCLUDING NEGLIGENCE OR OTHERWISE)
ARISING IN ANY WAY OUT OF THE USE OF THIS SOFTWARE, EVEN IF ADVISED OF THE
POSSIBILITY OF SUCH DAMAGE.

EXEMPTION FOR BINARY LIBRARY-LIKE PACKAGES

The second condition in the BSD licence (covering binary redistributions) does
not apply all the way down a chain of software. If binary package A includes
PCRE2, it must respect the condition, but if package B is software that
includes package A, the condition is not imposed on package B unless it uses
PCRE2 independently.

End

Pegtl-2

The MIT License (MIT)

Copyright (c) 2007-2020 Dr. Colin Hirsch and Daniel Frey

Permission is hereby granted, free of charge, to any person obtaining a copy
of this software and associated documentation files (the "Software"), to deal
in the Software without restriction, including without limitation the rights
to use, copy, modify, merge, publish, distribute, sublicense, and/or sell
copies of the Software, and to permit persons to whom the Software is

furnished to do so, subject to the following conditions:

The above copyright notice and this permission notice shall be included in all copies or substantial portions of the Software.

THE SOFTWARE IS PROVIDED "AS IS", WITHOUT WARRANTY OF ANY KIND, EXPRESS OR IMPLIED, INCLUDING BUT NOT LIMITED TO THE WARRANTIES OF MERCHANTABILITY, FITNESS FOR A PARTICULAR PURPOSE AND NONINFRINGEMENT. IN NO EVENT SHALL THE AUTHORS OR COPYRIGHT HOLDERS BE LIABLE FOR ANY CLAIM, DAMAGES OR OTHER LIABILITY, WHETHER IN AN ACTION OF CONTRACT, TORT OR OTHERWISE, ARISING FROM, OUT OF OR IN CONNECTION WITH THE SOFTWARE OR THE USE OR OTHER DEALINGS IN THE SOFTWARE.

Pkgconf

Copyright (c) 2011, 2012, 2013, 2014, 2015, 2016, 2017, 2018
pkgconf authors (see AUTHORS file in source directory).

Permission to use, copy, modify, and/or distribute this software for any purpose with or without fee is hereby granted, provided that the above copyright notice and this permission notice appear in all copies.

This software is provided 'as is' and without any warranty, express or implied. In no event shall the authors be liable for any damages arising from the use of this software.

Proj

All source, data files and other contents of the PROJ package are available under the following terms. Note that the PROJ 4.3 and earlier was "public domain" as is common with US government work, but apparently this is not a well defined legal term in many countries. Frank Warmerdam placed everything under the following MIT style license because he believed it is effectively the same as public domain, allowing anyone to use the code as they wish, including making proprietary derivatives.

Initial PROJ 4.3 public domain code was put as Frank Warmerdam as copyright holder, but he didn't mean to imply he did the work. Essentially all work was done by Gerald Evenden.

Copyright information can be found in source files.

Permission is hereby granted, free of charge, to any person obtaining a copy of this software and associated documentation files (the "Software"), to deal in the Software without restriction, including without limitation the rights to use, copy, modify, merge, publish, distribute, sublicense, and/or sell copies of the Software, and to permit persons to whom the Software is furnished to do so, subject to the following conditions:

The above copyright notice and this permission notice shall be included in all copies or substantial portions of the Software.

THE SOFTWARE IS PROVIDED "AS IS", WITHOUT WARRANTY OF ANY KIND, EXPRESS OR IMPLIED, INCLUDING BUT NOT LIMITED TO THE WARRANTIES OF MERCHANTABILITY, FITNESS FOR A PARTICULAR PURPOSE AND NONINFRINGEMENT. IN NO EVENT SHALL THE AUTHORS OR COPYRIGHT HOLDERS BE LIABLE FOR ANY CLAIM, DAMAGES OR OTHER LIABILITY, WHETHER IN AN ACTION OF CONTRACT, TORT OR OTHERWISE, ARISING FROM, OUT OF OR IN CONNECTION WITH THE SOFTWARE OR THE USE OR OTHER DEALINGS IN THE SOFTWARE.

Pugixml

MIT License

Copyright (c) 2006-2022 Arseny Kapoulkine

Permission is hereby granted, free of charge, to any person obtaining a copy of this software and associated documentation files (the "Software"), to deal in the Software without restriction, including without limitation the rights to use, copy, modify, merge, publish, distribute, sublicense, and/or sell copies of the Software, and to permit persons to whom the Software is furnished to do so, subject to the following conditions:

The above copyright notice and this permission notice shall be included in all copies or substantial portions of the Software.

THE SOFTWARE IS PROVIDED "AS IS", WITHOUT WARRANTY OF ANY KIND, EXPRESS OR IMPLIED, INCLUDING BUT NOT LIMITED TO THE WARRANTIES OF MERCHANTABILITY, FITNESS FOR A PARTICULAR PURPOSE AND NONINFRINGEMENT. IN NO EVENT SHALL THE AUTHORS OR COPYRIGHT HOLDERS BE LIABLE FOR ANY CLAIM, DAMAGES OR OTHER LIABILITY, WHETHER IN AN ACTION OF CONTRACT, TORT OR OTHERWISE, ARISING FROM, OUT OF OR IN CONNECTION WITH THE SOFTWARE OR THE USE OR OTHER DEALINGS IN THE SOFTWARE.

Qt5-base

GNU LESSER GENERAL PUBLIC LICENSE

The Qt Toolkit is Copyright (C) 2016 The Qt Company Ltd.
Contact: <http://www.qt.io/licensing/>

You may use, distribute and copy the Qt Toolkit under the terms of GNU Lesser General Public License version 3, which is displayed below. This license makes reference to the version 3 of the GNU General Public License, which you can find in the LICENSE.GPL3 file.

GNU LESSER GENERAL PUBLIC LICENSE Version 3, 29 June 2007

Copyright © 2007 Free Software Foundation, Inc. <<http://fsf.org/>>
Everyone is permitted to copy and distribute verbatim copies of this licensedocument, but changing it is not allowed.

This version of the GNU Lesser General Public License incorporates the terms and conditions of version 3 of the GNU General Public License, supplemented by the additional permissions listed below.

0. Additional Definitions.

As used herein, "this License" refers to version 3 of the GNU Lesser General Public License, and the "GNU GPL" refers to version 3 of the GNU General Public License.

"The Library" refers to a covered work governed by this License, other than an Application or a Combined Work as defined below.

An "Application" is any work that makes use of an interface provided by the Library, but which is not otherwise based on the Library. Defining a subclass of a class defined by the Library is deemed a mode of using an interface provided by the Library.

A "Combined Work" is a work produced by combining or linking an Application with the Library. The particular version of the Library with which the Combined Work was made is also called the "Linked Version".

The "Minimal Corresponding Source" for a Combined Work means the Corresponding Source for the Combined Work, excluding any source code

for portions of the Combined Work that, considered in isolation, are based on the Application, and not on the Linked Version.

The "Corresponding Application Code" for a Combined Work means the object code and/or source code for the Application, including any data and utility programs needed for reproducing the Combined Work from the Application, but excluding the System Libraries of the Combined Work.

1. Exception to Section 3 of the GNU GPL.

You may convey a covered work under sections 3 and 4 of this License without being bound by section 3 of the GNU GPL.

2. Conveying Modified Versions.

If you modify a copy of the Library, and, in your modifications, a facility refers to a function or data to be supplied by an Application that uses the facility (other than as an argument passed when the facility is invoked), then you may convey a copy of the modified version:

- a) under this License, provided that you make a good faith effort to ensure that, in the event an Application does not supply the function or data, the facility still operates, and performs whatever part of its purpose remains meaningful, or
- b) under the GNU GPL, with none of the additional permissions of this License applicable to that copy.

3. Object Code Incorporating Material from Library Header Files.

The object code form of an Application may incorporate material from a header file that is part of the Library. You may convey such object code under terms of your choice, provided that, if the incorporated material is not limited to numerical parameters, data structure layouts and accessors, or small macros, inline functions and templates (ten or fewer lines in length), you do both of the following:

- a) Give prominent notice with each copy of the object code that the Library is used in it and that the Library and its use are covered by this License.
- b) Accompany the object code with a copy of the GNU GPL and this license document.

4. Combined Works.

You may convey a Combined Work under terms of your choice that, taken together, effectively do not restrict modification of the portions of the Library contained in the Combined Work and reverse engineering for debugging such modifications, if you also do each of the following:

- a) Give prominent notice with each copy of the Combined Work that the Library is used in it and that the Library and its use are covered by this License.
- b) Accompany the Combined Work with a copy of the GNU GPL and this license document.
- c) For a Combined Work that displays copyright notices during execution, include the copyright notice for the Library among these notices, as well as a reference directing the user to the copies of the GNU GPL and this license document.
- d) Do one of the following:
 - 0) Convey the Minimal Corresponding Source under the terms of this License, and the Corresponding Application Code in a form suitable for, and under terms that permit, the user to recombine or relink the Application with a modified version of

the Linked Version to produce a modified Combined Work, in the manner specified by section 6 of the GNU GPL for conveying Corresponding Source.

1) Use a suitable shared library mechanism for linking with the Library. A suitable mechanism is one that (a) uses at run time a copy of the Library already present on the user's computer system, and (b) will operate properly with a modified version of the Library that is interface-compatible with the Linked Version.

e) Provide Installation Information, but only if you would otherwise be required to provide such information under section 6 of the GNU GPL, and only to the extent that such information is necessary to install and execute a modified version of the Combined Work produced by recombining or relinking the Application with a modified version of the Linked Version. (If you use option 4d0, the Installation Information must accompany the Minimal Corresponding Source and Corresponding Application Code. If you use option 4d1, you must provide the Installation Information in the manner specified by section 6 of the GNU GPL for conveying Corresponding Source.)

5. Combined Libraries.

You may place library facilities that are a work based on the Library side by side in a single library together with other library facilities that are not Applications and are not covered by this License, and convey such a combined library under terms of your choice, if you do both of the following:

- a) Accompany the combined library with a copy of the same work based on the Library, uncombined with any other library facilities, conveyed under the terms of this License.
- b) Give prominent notice with the combined library that part of it is a work based on the Library, and explaining where to find the accompanying uncombined form of the same work.

6. Revised Versions of the GNU Lesser General Public License.

The Free Software Foundation may publish revised and/or new versions of the GNU Lesser General Public License from time to time. Such new versions will be similar in spirit to the present version, but may differ in detail to address new problems or concerns.

Each version is given a distinguishing version number. If the Library as you received it specifies that a certain numbered version of the GNU Lesser General Public License "or any later version" applies to it, you have the option of following the terms and conditions either of that published version or of any later version published by the Free Software Foundation. If the Library as you received it does not specify a version number of the GNU Lesser General Public License, you may choose any version of the GNU Lesser General Public License ever published by the Free Software Foundation.

If the Library as you received it specifies that a proxy can decide whether future versions of the GNU Lesser General Public License shall apply, that proxy's public statement of acceptance of any version is permanent authorization for you to choose that version for the Library.

Qwt

Qwt License

Version 1.0, January 1, 2003

The Qwt library and included programs are provided under the terms of the GNU LESSER GENERAL PUBLIC LICENSE (LGPL) with the following exceptions:

1. Widgets that are subclassed from Qwt widgets do not constitute a derivative work.
2. Static linking of applications and widgets to the Qwt library does not constitute a derivative work and does not require the author to provide source code for the application or widget, use the shared Qwt libraries, or link their applications or widgets against a user-supplied version of Qwt.

If you link the application or widget to a modified version of Qwt, then the changes to Qwt must be provided under the terms of the LGPL in sections 1, 2, and 4.

3. You do not have to provide a copy of the Qwt license with programs that are linked to the Qwt library, nor do you have to identify the Qwt license in your program or documentation as required by section 6 of the LGPL.

However, programs must still identify their use of Qwt. The following example statement can be included in user documentation to satisfy this requirement:

```
[program/widget] is based in part on the work of
the Qwt project (http://qwt.sf.net).
```

GNU LESSER GENERAL PUBLIC LICENSE
Version 2.1, February 1999

Copyright (C) 1991, 1999 Free Software Foundation, Inc.
59 Temple Place, Suite 330, Boston, MA 02111-1307 USA
Everyone is permitted to copy and distribute verbatim copies
of this license document, but changing it is not allowed.

[This is the first released version of the Lesser GPL. It also counts
as the successor of the GNU Library Public License, version 2, hence
the version number 2.1.]

Preamble

The licenses for most software are designed to take away your
freedom to share and change it. By contrast, the GNU General Public
Licenses are intended to guarantee your freedom to share and change
free software--to make sure the software is free for all its users.

This license, the Lesser General Public License, applies to some
specially designated software packages--typically libraries--of the
Free Software Foundation and other authors who decide to use it. You
can use it too, but we suggest you first think carefully about whether
this license or the ordinary General Public License is the better
strategy to use in any particular case, based on the explanations below.

When we speak of free software, we are referring to freedom of use,
not price. Our General Public Licenses are designed to make sure that
you have the freedom to distribute copies of free software (and charge
for this service if you wish); that you receive source code or can get
it if you want it; that you can change the software and use pieces of
it in new free programs; and that you are informed that you can do
these things.

To protect your rights, we need to make restrictions that forbid
distributors to deny you these rights or to ask you to surrender these
rights. These restrictions translate to certain responsibilities for

you if you distribute copies of the library or if you modify it.

For example, if you distribute copies of the library, whether gratis or for a fee, you must give the recipients all the rights that we gave you. You must make sure that they, too, receive or can get the source code. If you link other code with the library, you must provide complete object files to the recipients, so that they can relink them with the library after making changes to the library and recompiling it. And you must show them these terms so they know their rights.

We protect your rights with a two-step method: (1) we copyright the library, and (2) we offer you this license, which gives you legal permission to copy, distribute and/or modify the library.

To protect each distributor, we want to make it very clear that there is no warranty for the free library. Also, if the library is modified by someone else and passed on, the recipients should know that what they have is not the original version, so that the original author's reputation will not be affected by problems that might be introduced by others.

Finally, software patents pose a constant threat to the existence of any free program. We wish to make sure that a company cannot effectively restrict the users of a free program by obtaining a restrictive license from a patent holder. Therefore, we insist that any patent license obtained for a version of the library must be consistent with the full freedom of use specified in this license.

Most GNU software, including some libraries, is covered by the ordinary GNU General Public License. This license, the GNU Lesser General Public License, applies to certain designated libraries, and is quite different from the ordinary General Public License. We use this license for certain libraries in order to permit linking those libraries into non-free programs.

When a program is linked with a library, whether statically or using a shared library, the combination of the two is legally speaking a combined work, a derivative of the original library. The ordinary General Public License therefore permits such linking only if the entire combination fits its criteria of freedom. The Lesser General Public License permits more lax criteria for linking other code with the library.

We call this license the "Lesser" General Public License because it does Less to protect the user's freedom than the ordinary General Public License. It also provides other free software developers Less of an advantage over competing non-free programs. These disadvantages are the reason we use the ordinary General Public License for many libraries. However, the Lesser license provides advantages in certain special circumstances.

For example, on rare occasions, there may be a special need to encourage the widest possible use of a certain library, so that it becomes a de-facto standard. To achieve this, non-free programs must be allowed to use the library. A more frequent case is that a free library does the same job as widely used non-free libraries. In this case, there is little to gain by limiting the free library to free software only, so we use the Lesser General Public License.

In other cases, permission to use a particular library in non-free programs enables a greater number of people to use a large body of free software. For example, permission to use the GNU C Library in non-free programs enables many more people to use the whole GNU operating system, as well as its variant, the GNU/Linux operating system.

Although the Lesser General Public License is Less protective of the users' freedom, it does ensure that the user of a program that is linked with the Library has the freedom and the wherewithal to run that program using a modified version of the Library.

The precise terms and conditions for copying, distribution and modification follow. Pay close attention to the difference between a "work based on the library" and a "work that uses the library". The former contains code derived from the library, whereas the latter must be combined with the library in order to run.

GNU LESSER GENERAL PUBLIC LICENSE
TERMS AND CONDITIONS FOR COPYING, DISTRIBUTION AND MODIFICATION

0. This License Agreement applies to any software library or other program which contains a notice placed by the copyright holder or other authorized party saying it may be distributed under the terms of this Lesser General Public License (also called "this License"). Each licensee is addressed as "you".

A "library" means a collection of software functions and/or data prepared so as to be conveniently linked with application programs (which use some of those functions and data) to form executables.

The "Library", below, refers to any such software library or work which has been distributed under these terms. A "work based on the Library" means either the Library or any derivative work under copyright law: that is to say, a work containing the Library or a portion of it, either verbatim or with modifications and/or translated straightforwardly into another language. (Hereinafter, translation is included without limitation in the term "modification".)

"Source code" for a work means the preferred form of the work for making modifications to it. For a library, complete source code means all the source code for all modules it contains, plus any associated interface definition files, plus the scripts used to control compilation and installation of the library.

Activities other than copying, distribution and modification are not covered by this License; they are outside its scope. The act of running a program using the Library is not restricted, and output from such a program is covered only if its contents constitute a work based on the Library (independent of the use of the Library in a tool for writing it). Whether that is true depends on what the Library does and what the program that uses the Library does.

1. You may copy and distribute verbatim copies of the Library's complete source code as you receive it, in any medium, provided that you conspicuously and appropriately publish on each copy an appropriate copyright notice and disclaimer of warranty; keep intact all the notices that refer to this License and to the absence of any warranty; and distribute a copy of this License along with the Library.

You may charge a fee for the physical act of transferring a copy, and you may at your option offer warranty protection in exchange for a fee.

2. You may modify your copy or copies of the Library or any portion of it, thus forming a work based on the Library, and copy and distribute such modifications or work under the terms of Section 1 above, provided that you also meet all of these conditions:

- a) The modified work must itself be a software library.
- b) You must cause the files modified to carry prominent notices stating that you changed the files and the date of any change.
- c) You must cause the whole of the work to be licensed at no charge to all third parties under the terms of this License.
- d) If a facility in the modified Library refers to a function or a table of data to be supplied by an application program that uses the facility, other than as an argument passed when the facility

is invoked, then you must make a good faith effort to ensure that, in the event an application does not supply such function or table, the facility still operates, and performs whatever part of its purpose remains meaningful.

(For example, a function in a library to compute square roots has a purpose that is entirely well-defined independent of the application. Therefore, Subsection 2d requires that any application-supplied function or table used by this function must be optional: if the application does not supply it, the square root function must still compute square roots.)

These requirements apply to the modified work as a whole. If identifiable sections of that work are not derived from the Library, and can be reasonably considered independent and separate works in themselves, then this License, and its terms, do not apply to those sections when you distribute them as separate works. But when you distribute the same sections as part of a whole which is a work based on the Library, the distribution of the whole must be on the terms of this License, whose permissions for other licensees extend to the entire whole, and thus to each and every part regardless of who wrote it.

Thus, it is not the intent of this section to claim rights or contest your rights to work written entirely by you; rather, the intent is to exercise the right to control the distribution of derivative or collective works based on the Library.

In addition, mere aggregation of another work not based on the Library with the Library (or with a work based on the Library) on a volume of a storage or distribution medium does not bring the other work under the scope of this License.

3. You may opt to apply the terms of the ordinary GNU General Public License instead of this License to a given copy of the Library. To do this, you must alter all the notices that refer to this License, so that they refer to the ordinary GNU General Public License, version 2, instead of to this License. (If a newer version than version 2 of the ordinary GNU General Public License has appeared, then you can specify that version instead if you wish.) Do not make any other change in these notices.

Once this change is made in a given copy, it is irreversible for that copy, so the ordinary GNU General Public License applies to all subsequent copies and derivative works made from that copy.

This option is useful when you wish to copy part of the code of the Library into a program that is not a library.

4. You may copy and distribute the Library (or a portion or derivative of it, under Section 2) in object code or executable form under the terms of Sections 1 and 2 above provided that you accompany it with the complete corresponding machine-readable source code, which must be distributed under the terms of Sections 1 and 2 above on a medium customarily used for software interchange.

If distribution of object code is made by offering access to copy from a designated place, then offering equivalent access to copy the source code from the same place satisfies the requirement to distribute the source code, even though third parties are not compelled to copy the source along with the object code.

5. A program that contains no derivative of any portion of the Library, but is designed to work with the Library by being compiled or linked with it, is called a "work that uses the Library". Such a work, in isolation, is not a derivative work of the Library, and therefore falls outside the scope of this License.

However, linking a "work that uses the Library" with the Library creates an executable that is a derivative of the Library (because it

contains portions of the Library), rather than a "work that uses the library". The executable is therefore covered by this License. Section 6 states terms for distribution of such executables.

When a "work that uses the Library" uses material from a header file that is part of the Library, the object code for the work may be a derivative work of the Library even though the source code is not. Whether this is true is especially significant if the work can be linked without the Library, or if the work is itself a library. The threshold for this to be true is not precisely defined by law.

If such an object file uses only numerical parameters, data structure layouts and accessors, and small macros and small inline functions (ten lines or less in length), then the use of the object file is unrestricted, regardless of whether it is legally a derivative work. (Executables containing this object code plus portions of the Library will still fall under Section 6.)

Otherwise, if the work is a derivative of the Library, you may distribute the object code for the work under the terms of Section 6. Any executables containing that work also fall under Section 6, whether or not they are linked directly with the Library itself.

6. As an exception to the Sections above, you may also combine or link a "work that uses the Library" with the Library to produce a work containing portions of the Library, and distribute that work under terms of your choice, provided that the terms permit modification of the work for the customer's own use and reverse engineering for debugging such modifications.

You must give prominent notice with each copy of the work that the Library is used in it and that the Library and its use are covered by this License. You must supply a copy of this License. If the work during execution displays copyright notices, you must include the copyright notice for the Library among them, as well as a reference directing the user to the copy of this License. Also, you must do one of these things:

- a) Accompany the work with the complete corresponding machine-readable source code for the Library including whatever changes were used in the work (which must be distributed under Sections 1 and 2 above); and, if the work is an executable linked with the Library, with the complete machine-readable "work that uses the Library", as object code and/or source code, so that the user can modify the Library and then relink to produce a modified executable containing the modified Library. (It is understood that the user who changes the contents of definitions files in the Library will not necessarily be able to recompile the application to use the modified definitions.)
- b) Use a suitable shared library mechanism for linking with the Library. A suitable mechanism is one that (1) uses at run time a copy of the library already present on the user's computer system, rather than copying library functions into the executable, and (2) will operate properly with a modified version of the library, if the user installs one, as long as the modified version is interface-compatible with the version that the work was made with.
- c) Accompany the work with a written offer, valid for at least three years, to give the same user the materials specified in Subsection 6a, above, for a charge no more than the cost of performing this distribution.
- d) If distribution of the work is made by offering access to copy from a designated place, offer equivalent access to copy the above specified materials from the same place.
- e) Verify that the user has already received a copy of these materials or that you have already sent this user a copy.

For an executable, the required form of the "work that uses the Library" must include any data and utility programs needed for reproducing the executable from it. However, as a special exception, the materials to be distributed need not include anything that is normally distributed (in either source or binary form) with the major components (compiler, kernel, and so on) of the operating system on which the executable runs, unless that component itself accompanies the executable.

It may happen that this requirement contradicts the license restrictions of other proprietary libraries that do not normally accompany the operating system. Such a contradiction means you cannot use both them and the Library together in an executable that you distribute.

7. You may place library facilities that are a work based on the Library side-by-side in a single library together with other library facilities not covered by this License, and distribute such a combined library, provided that the separate distribution of the work based on the Library and of the other library facilities is otherwise permitted, and provided that you do these two things:

- a) Accompany the combined library with a copy of the same work based on the Library, uncombined with any other library facilities. This must be distributed under the terms of the Sections above.
- b) Give prominent notice with the combined library of the fact that part of it is a work based on the Library, and explaining where to find the accompanying uncombined form of the same work.

8. You may not copy, modify, sublicense, link with, or distribute the Library except as expressly provided under this License. Any attempt otherwise to copy, modify, sublicense, link with, or distribute the Library is void, and will automatically terminate your rights under this License. However, parties who have received copies, or rights, from you under this License will not have their licenses terminated so long as such parties remain in full compliance.

9. You are not required to accept this License, since you have not signed it. However, nothing else grants you permission to modify or distribute the Library or its derivative works. These actions are prohibited by law if you do not accept this License. Therefore, by modifying or distributing the Library (or any work based on the Library), you indicate your acceptance of this License to do so, and all its terms and conditions for copying, distributing or modifying the Library or works based on it.

10. Each time you redistribute the Library (or any work based on the Library), the recipient automatically receives a license from the original licensor to copy, distribute, link with or modify the Library subject to these terms and conditions. You may not impose any further restrictions on the recipients' exercise of the rights granted herein. You are not responsible for enforcing compliance by third parties with this License.

11. If, as a consequence of a court judgment or allegation of patent infringement or for any other reason (not limited to patent issues), conditions are imposed on you (whether by court order, agreement or otherwise) that contradict the conditions of this License, they do not excuse you from the conditions of this License. If you cannot distribute so as to satisfy simultaneously your obligations under this License and any other pertinent obligations, then as a consequence you may not distribute the Library at all. For example, if a patent license would not permit royalty-free redistribution of the Library by all those who receive copies directly or indirectly through you, then the only way you could satisfy both it and this License would be to refrain entirely from distribution of the Library.

If any portion of this section is held invalid or unenforceable under any

particular circumstance, the balance of the section is intended to apply, and the section as a whole is intended to apply in other circumstances.

It is not the purpose of this section to induce you to infringe any patents or other property right claims or to contest validity of any such claims; this section has the sole purpose of protecting the integrity of the free software distribution system which is implemented by public license practices. Many people have made generous contributions to the wide range of software distributed through that system in reliance on consistent application of that system; it is up to the author/donor to decide if he or she is willing to distribute software through any other system and a licensee cannot impose that choice.

This section is intended to make thoroughly clear what is believed to be a consequence of the rest of this License.

12. If the distribution and/or use of the Library is restricted in certain countries either by patents or by copyrighted interfaces, the original copyright holder who places the Library under this License may add an explicit geographical distribution limitation excluding those countries, so that distribution is permitted only in or among countries not thus excluded. In such case, this License incorporates the limitation as if written in the body of this License.

13. The Free Software Foundation may publish revised and/or new versions of the Lesser General Public License from time to time. Such new versions will be similar in spirit to the present version, but may differ in detail to address new problems or concerns.

Each version is given a distinguishing version number. If the Library specifies a version number of this License which applies to it and "any later version", you have the option of following the terms and conditions either of that version or of any later version published by the Free Software Foundation. If the Library does not specify a license version number, you may choose any version ever published by the Free Software Foundation.

14. If you wish to incorporate parts of the Library into other free programs whose distribution conditions are incompatible with these, write to the author to ask for permission. For software which is copyrighted by the Free Software Foundation, write to the Free Software Foundation; we sometimes make exceptions for this. Our decision will be guided by the two goals of preserving the free status of all derivatives of our free software and of promoting the sharing and reuse of software generally.

NO WARRANTY

15. BECAUSE THE LIBRARY IS LICENSED FREE OF CHARGE, THERE IS NO WARRANTY FOR THE LIBRARY, TO THE EXTENT PERMITTED BY APPLICABLE LAW. EXCEPT WHEN OTHERWISE STATED IN WRITING THE COPYRIGHT HOLDERS AND/OR OTHER PARTIES PROVIDE THE LIBRARY "AS IS" WITHOUT WARRANTY OF ANY KIND, EITHER EXPRESSED OR IMPLIED, INCLUDING, BUT NOT LIMITED TO, THE IMPLIED WARRANTIES OF MERCHANTABILITY AND FITNESS FOR A PARTICULAR PURPOSE. THE ENTIRE RISK AS TO THE QUALITY AND PERFORMANCE OF THE LIBRARY IS WITH YOU. SHOULD THE LIBRARY PROVE DEFECTIVE, YOU ASSUME THE COST OF ALL NECESSARY SERVICING, REPAIR OR CORRECTION.

16. IN NO EVENT UNLESS REQUIRED BY APPLICABLE LAW OR AGREED TO IN WRITING WILL ANY COPYRIGHT HOLDER, OR ANY OTHER PARTY WHO MAY MODIFY AND/OR REDISTRIBUTE THE LIBRARY AS PERMITTED ABOVE, BE LIABLE TO YOU FOR DAMAGES, INCLUDING ANY GENERAL, SPECIAL, INCIDENTAL OR CONSEQUENTIAL DAMAGES ARISING OUT OF THE USE OR INABILITY TO USE THE LIBRARY (INCLUDING BUT NOT LIMITED TO LOSS OF DATA OR DATA BEING RENDERED INACCURATE OR LOSSES SUSTAINED BY YOU OR THIRD PARTIES OR A FAILURE OF THE LIBRARY TO OPERATE WITH ANY OTHER SOFTWARE), EVEN IF SUCH HOLDER OR OTHER PARTY HAS BEEN ADVISED OF THE POSSIBILITY OF SUCH DAMAGES.

END OF TERMS AND CONDITIONS

How to Apply These Terms to Your New Libraries

If you develop a new library, and you want it to be of the greatest possible use to the public, we recommend making it free software that everyone can redistribute and change. You can do so by permitting redistribution under these terms (or, alternatively, under the terms of the ordinary General Public License).

To apply these terms, attach the following notices to the library. It is safest to attach them to the start of each source file to most effectively convey the exclusion of warranty; and each file should have at least the "copyright" line and a pointer to where the full notice is found.

```
<one line to give the library's name and a brief idea of what it does.>
Copyright (C) <year> <name of author>
```

```
This library is free software; you can redistribute it and/or
modify it under the terms of the GNU Lesser General Public
License as published by the Free Software Foundation; either
version 2.1 of the License, or (at your option) any later version.
```

```
This library is distributed in the hope that it will be useful,
but WITHOUT ANY WARRANTY; without even the implied warranty of
MERCHANTABILITY or FITNESS FOR A PARTICULAR PURPOSE. See the GNU
Lesser General Public License for more details.
```

```
You should have received a copy of the GNU Lesser General Public
License along with this library; if not, write to the Free Software
Foundation, Inc., 59 Temple Place, Suite 330, Boston, MA 02111-1307 USA
```

Also add information on how to contact you by electronic and paper mail.

You should also get your employer (if you work as a programmer) or your school, if any, to sign a "copyright disclaimer" for the library, if necessary. Here is a sample; alter the names:

```
Yoyodyne, Inc., hereby disclaims all copyright interest in the
library `Frob' (a library for tweaking knobs) written by James Random Hacker.
```

```
<signature of Ty Coon>, 1 April 1990
Ty Coon, President of Vice
```

That's all there is to it!

ShapelibGNU LIBRARY GENERAL PUBLIC LICENSE
Version 2, June 1991

```
Copyright (C) 1991 Free Software Foundation, Inc.
        675 Mass Ave, Cambridge, MA 02139, USA
Everyone is permitted to copy and distribute verbatim copies
of this license document, but changing it is not allowed.
```

[This is the first released version of the library GPL. It is numbered 2 because it goes with version 2 of the ordinary GPL.]

Preamble

The licenses for most software are designed to take away your freedom to share and change it. By contrast, the GNU General Public Licenses are intended to guarantee your freedom to share and change free software--to make sure the software is free for all its users.

This license, the Library General Public License, applies to some specially designated Free Software Foundation software, and to any other libraries whose authors decide to use it. You can use it for

your libraries, too.

When we speak of free software, we are referring to freedom, not price. Our General Public Licenses are designed to make sure that you have the freedom to distribute copies of free software (and charge for this service if you wish), that you receive source code or can get it if you want it, that you can change the software or use pieces of it in new free programs; and that you know you can do these things.

To protect your rights, we need to make restrictions that forbid anyone to deny you these rights or to ask you to surrender the rights. These restrictions translate to certain responsibilities for you if you distribute copies of the library, or if you modify it.

For example, if you distribute copies of the library, whether gratis or for a fee, you must give the recipients all the rights that we gave you. You must make sure that they, too, receive or can get the source code. If you link a program with the library, you must provide complete object files to the recipients so that they can relink them with the library, after making changes to the library and recompiling it. And you must show them these terms so they know their rights.

Our method of protecting your rights has two steps: (1) copyright the library, and (2) offer you this license which gives you legal permission to copy, distribute and/or modify the library.

Also, for each distributor's protection, we want to make certain that everyone understands that there is no warranty for this free library. If the library is modified by someone else and passed on, we want its recipients to know that what they have is not the original version, so that any problems introduced by others will not reflect on the original authors' reputations.

Finally, any free program is threatened constantly by software patents. We wish to avoid the danger that companies distributing free software will individually obtain patent licenses, thus in effect transforming the program into proprietary software. To prevent this, we have made it clear that any patent must be licensed for everyone's free use or not licensed at all.

Most GNU software, including some libraries, is covered by the ordinary GNU General Public License, which was designed for utility programs. This license, the GNU Library General Public License, applies to certain designated libraries. This license is quite different from the ordinary one; be sure to read it in full, and don't assume that anything in it is the same as in the ordinary license.

The reason we have a separate public license for some libraries is that they blur the distinction we usually make between modifying or adding to a program and simply using it. Linking a program with a library, without changing the library, is in some sense simply using the library, and is analogous to running a utility program or application program. However, in a textual and legal sense, the linked executable is a combined work, a derivative of the original library, and the ordinary General Public License treats it as such.

Because of this blurred distinction, using the ordinary General Public License for libraries did not effectively promote software sharing, because most developers did not use the libraries. We concluded that weaker conditions might promote sharing better.

However, unrestricted linking of non-free programs would deprive the users of those programs of all benefit from the free status of the libraries themselves. This Library General Public License is intended to permit developers of non-free programs to use free libraries, while preserving your freedom as a user of such programs to change the free libraries that are incorporated in them. (We have not seen how to achieve this as regards changes in header files, but we have achieved it as regards changes in the actual functions of the Library.) The hope is that this will lead to faster development of free libraries.

The precise terms and conditions for copying, distribution and modification follow. Pay close attention to the difference between a "work based on the library" and a "work that uses the library". The former contains code derived from the library, while the latter only works together with the library.

Note that it is possible for a library to be covered by the ordinary General Public License rather than by this special one.

GNU LIBRARY GENERAL PUBLIC LICENSE
TERMS AND CONDITIONS FOR COPYING, DISTRIBUTION AND MODIFICATION

0. This License Agreement applies to any software library which contains a notice placed by the copyright holder or other authorized party saying it may be distributed under the terms of this Library General Public License (also called "this License"). Each licensee is addressed as "you".

A "library" means a collection of software functions and/or data prepared so as to be conveniently linked with application programs (which use some of those functions and data) to form executables.

The "Library", below, refers to any such software library or work which has been distributed under these terms. A "work based on the Library" means either the Library or any derivative work under copyright law: that is to say, a work containing the Library or a portion of it, either verbatim or with modifications and/or translated straightforwardly into another language. (Hereinafter, translation is included without limitation in the term "modification".)

"Source code" for a work means the preferred form of the work for making modifications to it. For a library, complete source code means all the source code for all modules it contains, plus any associated interface definition files, plus the scripts used to control compilation and installation of the library.

Activities other than copying, distribution and modification are not covered by this License; they are outside its scope. The act of running a program using the Library is not restricted, and output from such a program is covered only if its contents constitute a work based on the Library (independent of the use of the Library in a tool for writing it). Whether that is true depends on what the Library does and what the program that uses the Library does.

1. You may copy and distribute verbatim copies of the Library's complete source code as you receive it, in any medium, provided that you conspicuously and appropriately publish on each copy an appropriate copyright notice and disclaimer of warranty; keep intact all the notices that refer to this License and to the absence of any warranty; and distribute a copy of this License along with the Library.

You may charge a fee for the physical act of transferring a copy, and you may at your option offer warranty protection in exchange for a fee.

2. You may modify your copy or copies of the Library or any portion of it, thus forming a work based on the Library, and copy and distribute such modifications or work under the terms of Section 1 above, provided that you also meet all of these conditions:

- a) The modified work must itself be a software library.
- b) You must cause the files modified to carry prominent notices stating that you changed the files and the date of any change.
- c) You must cause the whole of the work to be licensed at no charge to all third parties under the terms of this License.

d) If a facility in the modified Library refers to a function or a table of data to be supplied by an application program that uses the facility, other than as an argument passed when the facility is invoked, then you must make a good faith effort to ensure that, in the event an application does not supply such function or table, the facility still operates, and performs whatever part of its purpose remains meaningful.

(For example, a function in a library to compute square roots has a purpose that is entirely well-defined independent of the application. Therefore, Subsection 2d requires that any application-supplied function or table used by this function must be optional: if the application does not supply it, the square root function must still compute square roots.)

These requirements apply to the modified work as a whole. If identifiable sections of that work are not derived from the Library, and can be reasonably considered independent and separate works in themselves, then this License, and its terms, do not apply to those sections when you distribute them as separate works. But when you distribute the same sections as part of a whole which is a work based on the Library, the distribution of the whole must be on the terms of this License, whose permissions for other licensees extend to the entire whole, and thus to each and every part regardless of who wrote it.

Thus, it is not the intent of this section to claim rights or contest your rights to work written entirely by you; rather, the intent is to exercise the right to control the distribution of derivative or collective works based on the Library.

In addition, mere aggregation of another work not based on the Library with the Library (or with a work based on the Library) on a volume of a storage or distribution medium does not bring the other work under the scope of this License.

3. You may opt to apply the terms of the ordinary GNU General Public License instead of this License to a given copy of the Library. To do this, you must alter all the notices that refer to this License, so that they refer to the ordinary GNU General Public License, version 2, instead of to this License. (If a newer version than version 2 of the ordinary GNU General Public License has appeared, then you can specify that version instead if you wish.) Do not make any other change in these notices.

Once this change is made in a given copy, it is irreversible for that copy, so the ordinary GNU General Public License applies to all subsequent copies and derivative works made from that copy.

This option is useful when you wish to copy part of the code of the Library into a program that is not a library.

4. You may copy and distribute the Library (or a portion or derivative of it, under Section 2) in object code or executable form under the terms of Sections 1 and 2 above provided that you accompany it with the complete corresponding machine-readable source code, which must be distributed under the terms of Sections 1 and 2 above on a medium customarily used for software interchange.

If distribution of object code is made by offering access to copy from a designated place, then offering equivalent access to copy the source code from the same place satisfies the requirement to distribute the source code, even though third parties are not compelled to copy the source along with the object code.

5. A program that contains no derivative of any portion of the Library, but is designed to work with the Library by being compiled or linked with it, is called a "work that uses the Library". Such a work, in isolation, is not a derivative work of the Library, and therefore falls outside the scope of this License.

However, linking a "work that uses the Library" with the Library creates an executable that is a derivative of the Library (because it contains portions of the Library), rather than a "work that uses the library". The executable is therefore covered by this License. Section 6 states terms for distribution of such executables.

When a "work that uses the Library" uses material from a header file that is part of the Library, the object code for the work may be a derivative work of the Library even though the source code is not. Whether this is true is especially significant if the work can be linked without the Library, or if the work is itself a library. The threshold for this to be true is not precisely defined by law.

If such an object file uses only numerical parameters, data structure layouts and accessors, and small macros and small inline functions (ten lines or less in length), then the use of the object file is unrestricted, regardless of whether it is legally a derivative work. (Executables containing this object code plus portions of the Library will still fall under Section 6.)

Otherwise, if the work is a derivative of the Library, you may distribute the object code for the work under the terms of Section 6. Any executables containing that work also fall under Section 6, whether or not they are linked directly with the Library itself.

6. As an exception to the Sections above, you may also compile or link a "work that uses the Library" with the Library to produce a work containing portions of the Library, and distribute that work under terms of your choice, provided that the terms permit modification of the work for the customer's own use and reverse engineering for debugging such modifications.

You must give prominent notice with each copy of the work that the Library is used in it and that the Library and its use are covered by this License. You must supply a copy of this License. If the work during execution displays copyright notices, you must include the copyright notice for the Library among them, as well as a reference directing the user to the copy of this License. Also, you must do one of these things:

- a) Accompany the work with the complete corresponding machine-readable source code for the Library including whatever changes were used in the work (which must be distributed under Sections 1 and 2 above); and, if the work is an executable linked with the Library, with the complete machine-readable "work that uses the Library", as object code and/or source code, so that the user can modify the Library and then relink to produce a modified executable containing the modified Library. (It is understood that the user who changes the contents of definitions files in the Library will not necessarily be able to recompile the application to use the modified definitions.)
- b) Accompany the work with a written offer, valid for at least three years, to give the same user the materials specified in Subsection 6a, above, for a charge no more than the cost of performing this distribution.
- c) If distribution of the work is made by offering access to copy from a designated place, offer equivalent access to copy the above specified materials from the same place.
- d) Verify that the user has already received a copy of these materials or that you have already sent this user a copy.

For an executable, the required form of the "work that uses the Library" must include any data and utility programs needed for reproducing the executable from it. However, as a special exception, the source code distributed need not include anything that is normally distributed (in either source or binary form) with the major

components (compiler, kernel, and so on) of the operating system on which the executable runs, unless that component itself accompanies the executable.

It may happen that this requirement contradicts the license restrictions of other proprietary libraries that do not normally accompany the operating system. Such a contradiction means you cannot use both them and the Library together in an executable that you distribute.

7. You may place library facilities that are a work based on the Library side-by-side in a single library together with other library facilities not covered by this License, and distribute such a combined library, provided that the separate distribution of the work based on the Library and of the other library facilities is otherwise permitted, and provided that you do these two things:

- a) Accompany the combined library with a copy of the same work based on the Library, uncombined with any other library facilities. This must be distributed under the terms of the Sections above.
- b) Give prominent notice with the combined library of the fact that part of it is a work based on the Library, and explaining where to find the accompanying uncombined form of the same work.

8. You may not copy, modify, sublicense, link with, or distribute the Library except as expressly provided under this License. Any attempt otherwise to copy, modify, sublicense, link with, or distribute the Library is void, and will automatically terminate your rights under this License. However, parties who have received copies, or rights, from you under this License will not have their licenses terminated so long as such parties remain in full compliance.

9. You are not required to accept this License, since you have not signed it. However, nothing else grants you permission to modify or distribute the Library or its derivative works. These actions are prohibited by law if you do not accept this License. Therefore, by modifying or distributing the Library (or any work based on the Library), you indicate your acceptance of this License to do so, and all its terms and conditions for copying, distributing or modifying the Library or works based on it.

10. Each time you redistribute the Library (or any work based on the Library), the recipient automatically receives a license from the original licensor to copy, distribute, link with or modify the Library subject to these terms and conditions. You may not impose any further restrictions on the recipients' exercise of the rights granted herein. You are not responsible for enforcing compliance by third parties to this License.

11. If, as a consequence of a court judgment or allegation of patent infringement or for any other reason (not limited to patent issues), conditions are imposed on you (whether by court order, agreement or otherwise) that contradict the conditions of this License, they do not excuse you from the conditions of this License. If you cannot distribute so as to satisfy simultaneously your obligations under this License and any other pertinent obligations, then as a consequence you may not distribute the Library at all. For example, if a patent license would not permit royalty-free redistribution of the Library by all those who receive copies directly or indirectly through you, then the only way you could satisfy both it and this License would be to refrain entirely from distribution of the Library.

If any portion of this section is held invalid or unenforceable under any particular circumstance, the balance of the section is intended to apply, and the section as a whole is intended to apply in other circumstances.

It is not the purpose of this section to induce you to infringe any patents or other property right claims or to contest validity of any

such claims; this section has the sole purpose of protecting the integrity of the free software distribution system which is implemented by public license practices. Many people have made generous contributions to the wide range of software distributed through that system in reliance on consistent application of that system; it is up to the author/donor to decide if he or she is willing to distribute software through any other system and a licensee cannot impose that choice.

This section is intended to make thoroughly clear what is believed to be a consequence of the rest of this License.

12. If the distribution and/or use of the Library is restricted in certain countries either by patents or by copyrighted interfaces, the original copyright holder who places the Library under this License may add an explicit geographical distribution limitation excluding those countries, so that distribution is permitted only in or among countries not thus excluded. In such case, this License incorporates the limitation as if written in the body of this License.

13. The Free Software Foundation may publish revised and/or new versions of the Library General Public License from time to time. Such new versions will be similar in spirit to the present version, but may differ in detail to address new problems or concerns.

Each version is given a distinguishing version number. If the Library specifies a version number of this License which applies to it and "any later version", you have the option of following the terms and conditions either of that version or of any later version published by the Free Software Foundation. If the Library does not specify a license version number, you may choose any version ever published by the Free Software Foundation.

14. If you wish to incorporate parts of the Library into other free programs whose distribution conditions are incompatible with these, write to the author to ask for permission. For software which is copyrighted by the Free Software Foundation, write to the Free Software Foundation; we sometimes make exceptions for this. Our decision will be guided by the two goals of preserving the free status of all derivatives of our free software and of promoting the sharing and reuse of software generally.

NO WARRANTY

15. BECAUSE THE LIBRARY IS LICENSED FREE OF CHARGE, THERE IS NO WARRANTY FOR THE LIBRARY, TO THE EXTENT PERMITTED BY APPLICABLE LAW. EXCEPT WHEN OTHERWISE STATED IN WRITING THE COPYRIGHT HOLDERS AND/OR OTHER PARTIES PROVIDE THE LIBRARY "AS IS" WITHOUT WARRANTY OF ANY KIND, EITHER EXPRESSED OR IMPLIED, INCLUDING, BUT NOT LIMITED TO, THE IMPLIED WARRANTIES OF MERCHANTABILITY AND FITNESS FOR A PARTICULAR PURPOSE. THE ENTIRE RISK AS TO THE QUALITY AND PERFORMANCE OF THE LIBRARY IS WITH YOU. SHOULD THE LIBRARY PROVE DEFECTIVE, YOU ASSUME THE COST OF ALL NECESSARY SERVICING, REPAIR OR CORRECTION.

16. IN NO EVENT UNLESS REQUIRED BY APPLICABLE LAW OR AGREED TO IN WRITING WILL ANY COPYRIGHT HOLDER, OR ANY OTHER PARTY WHO MAY MODIFY AND/OR REDISTRIBUTE THE LIBRARY AS PERMITTED ABOVE, BE LIABLE TO YOU FOR DAMAGES, INCLUDING ANY GENERAL, SPECIAL, INCIDENTAL OR CONSEQUENTIAL DAMAGES ARISING OUT OF THE USE OR INABILITY TO USE THE LIBRARY (INCLUDING BUT NOT LIMITED TO LOSS OF DATA OR DATA BEING RENDERED INACCURATE OR LOSSES SUSTAINED BY YOU OR THIRD PARTIES OR A FAILURE OF THE LIBRARY TO OPERATE WITH ANY OTHER SOFTWARE), EVEN IF SUCH HOLDER OR OTHER PARTY HAS BEEN ADVISED OF THE POSSIBILITY OF SUCH DAMAGES.

END OF TERMS AND CONDITIONS

Appendix: How to Apply These Terms to Your New Libraries

If you develop a new library, and you want it to be of the greatest

possible use to the public, we recommend making it free software that everyone can redistribute and change. You can do so by permitting redistribution under these terms (or, alternatively, under the terms of the ordinary General Public License).

To apply these terms, attach the following notices to the library. It is safest to attach them to the start of each source file to most effectively convey the exclusion of warranty; and each file should have at least the "copyright" line and a pointer to where the full notice is found.

```
<one line to give the library's name and a brief idea of what it does.>
Copyright (C) <year> <name of author>
```

```
This library is free software; you can redistribute it and/or
modify it under the terms of the GNU Library General Public
License as published by the Free Software Foundation; either
version 2 of the License, or (at your option) any later version.
```

```
This library is distributed in the hope that it will be useful,
but WITHOUT ANY WARRANTY; without even the implied warranty of
MERCHANTABILITY or FITNESS FOR A PARTICULAR PURPOSE. See the GNU
Library General Public License for more details.
```

```
You should have received a copy of the GNU Library General Public
License along with this library; if not, write to the Free
Software Foundation, Inc., 675 Mass Ave, Cambridge, MA 02139, USA.
```

Also add information on how to contact you by electronic and paper mail.

You should also get your employer (if you work as a programmer) or your school, if any, to sign a "copyright disclaimer" for the library, if necessary. Here is a sample; alter the names:

```
Yoyodyne, Inc., hereby disclaims all copyright interest in the
library `Frob' (a library for tweaking knobs) written by James Random Hacker.
```

```
<signature of Ty Coon>, 1 April 1990
Ty Coon, President of Vice
```

That's all there is to it!

SQLite3

SQLite is in the Public Domain.
<http://www.sqlite.org/copyright.html>

Tecio

Tecplot, Inc. LICENSE AGREEMENT FOR Tecplot's TecIO ("TecIO")

TecIO is a software library provided by Tecplot, Inc. to enable software developed by others to write data in Tecplot's proprietary binary file formats, .plt and .szplt, and to read Tecplot binary data in .plt and .szplt format. TecIO is included with Tecplot 360 EX and may also be downloaded from <http://www.tecplot.com/downloads/tecio-library/>.

This license applies to versions of the TecIO library distributed with Tecplot 360 EX 2016 R2 and later and covers both the serial and parallel (MPI) versions of the library.

1. This LICENSE AGREEMENT is between Tecplot, Inc. ("Tecplot"), and the Individual or Organization ("Licensee") accessing and otherwise using TecIO software in source or binary form and its associated documentation.
2. Licensee acknowledges that this is only a limited nonexclusive license. Tecplot is and remains the owner of all titles, rights, and interests in TecIO Software. Title to TecIO and all copies thereof remain with Tecplot. The

Materials are copyrighted and are protected by United States copyright laws and international treaty provisions. Licensee will not remove any copyright notice from the Materials. Tecplot does not grant any express or implied right to you under Tecplot patents, copyrights, trademarks, or trade secret information.

3. Subject to the terms and conditions of this License Agreement, Tecplot hereby grants Licensee a nonexclusive, royalty-free, world-wide license to reproduce, analyze, test, perform and/or display publicly, prepare derivative works, distribute, and otherwise use TecIO alone or in any derivative version, provided, however, that Tecplot's License Agreement and Tecplot's notice of copyright, i.e., "Copyright © 1988-2016 Tecplot, Inc. All rights reserved worldwide." are retained in TecIO alone or in any derivative version prepared by Licensee.

4. In the event Licensee prepares a derivative work that is based on or incorporates TecIO or any part thereof, and wants to publish the derivative work as provided herein, Licensee hereby agrees to provide to all end users of any such work a brief summary of all changes made to TecIO, and to convey to Tecplot a copy of the modified TecIO source code within 30 days after publication of any work containing any such changes.

5. Tecplot is making TecIO available to Licensee on an "AS IS" basis. NO OTHER WARRANTIES. TO THE MAXIMUM EXTENT PERMITTED BY APPLICABLE LAW, TECPLOT, INC. AND ITS SUPPLIERS DISCLAIM ALL OTHER WARRANTIES AND CONDITIONS, EITHER EXPRESS OR IMPLIED, INCLUDING, BUT NOT LIMITED TO, IMPLIED WARRANTIES OF MERCHANTABILITY, FITNESS FOR A PARTICULAR PURPOSE, TITLE, AND NONINFRINGEMENT, WITH REGARD TO THE SOFTWARE, AND THE PROVISION OF OR FAILURE TO PROVIDE SUPPORT SERVICES. APART FROM THE WARRANTIES STATED ABOVE, TECPLOT, INC. MAKES NO WARRANTY THAT THE SOFTWARE OR SERVICES WILL: MEET REQUIREMENTS; PROVIDE UNINTERRUPTED, TIMELY, SECURE, OR ERROR-FREE, USE OF COMPUTERS OR NETWORKS; PROVIDE RESULTS WHICH ARE ACCURATE OR RELIABLE; MEET EXPECTATIONS, OR; CORRECT ANY ERRORS IN THE SOFTWARE. TECPLOT, INC. SHALL NOT BE RESPONSIBLE FOR MISUSE OF THE SOFTWARE OR ANY LOSS OF DATA. THIS LIMITED WARRANTY GIVES YOU SPECIFIC LEGAL RIGHTS. YOU MAY HAVE OTHERS, WHICH VARY FROM STATE/JURISDICTION TO STATE/JURISDICTION.

6. TO THE MAXIMUM EXTENT PERMITTED BY APPLICABLE LAW, IN NO EVENT SHALL TECPLOT, INC. OR ITS SUPPLIERS BE LIABLE FOR ANY SPECIAL, INCIDENTAL, INDIRECT, OR CONSEQUENTIAL DAMAGES WHATSOEVER (INCLUDING, WITHOUT LIMITATION, DAMAGES FOR LOSS OF BUSINESS PROFITS, BUSINESS INTERRUPTION, LOSS OF BUSINESS INFORMATION, OR ANY OTHER PECUNIARY LOSS) ARISING OUT OF THE USE OF OR INABILITY TO USE THE SOFTWARE OR THE PROVISION OF OR FAILURE TO PROVIDE SUPPORT SERVICES, EVEN IF TECPLOT, INC. HAS BEEN ADVISED OF THE POSSIBILITY OF SUCH DAMAGES. THIS SHALL BE TRUE EVEN IN THE EVENT OF THE FAILURE OF AN AGREED REMEDY. IN ANY CASE, TECPLOT, INC.'S ENTIRE LIABILITY FOR CLAIMS ARISING OUT OF USE OF THE SOFTWARE, SERVICE OR ARISING FROM ANY PROVISION OF THIS AGREEMENT SHALL BE LIMITED TO THE AMOUNT ACTUALLY PAID BY LICENSEE FOR THE SOFTWARE OR SERVICE COMPLAINED OF. BECAUSE SOME STATES AND JURISDICTIONS DO NOT ALLOW THE EXCLUSION OR LIMITATION OF LIABILITY, THE ABOVE LIMITATION MAY NOT APPLY TO YOU.

7. This License Agreement will automatically terminate upon a material breach of its terms and conditions.

8. Nothing in this License Agreement shall be deemed to create any relationship of agency, partnership, or joint venture between Tecplot and Licensee. This License Agreement does not grant permission to use Tecplot trademarks or trade name in a trademark sense to endorse or promote products or services of Licensee, or any third party.

9. By copying, installing or otherwise using TecIO, Licensee agrees to be bound by the terms and conditions of this License Agreement.

Telap

Copyright (c) 2003 Michael E. Smoot
Copyright (c) 2004 Daniel Aarno
Copyright (c) 2017 Google Inc.

Permission is hereby granted, free of charge, to any person

obtaining a copy of this software and associated documentation files (the "Software"), to deal in the Software without restriction, including without limitation the rights to use, copy, modify, merge, publish, distribute, sublicense, and/or sell copies of the Software, and to permit persons to whom the Software is furnished to do so, subject to the following conditions:

The above copyright notice and this permission notice shall be included in all copies or substantial portions of the Software.

THE SOFTWARE IS PROVIDED "AS IS", WITHOUT WARRANTY OF ANY KIND, EXPRESS OR IMPLIED, INCLUDING BUT NOT LIMITED TO THE WARRANTIES OF MERCHANTABILITY, FITNESS FOR A PARTICULAR PURPOSE AND NONINFRINGEMENT. IN NO EVENT SHALL THE AUTHORS OR COPYRIGHT HOLDERS BE LIABLE FOR ANY CLAIM, DAMAGES OR OTHER LIABILITY, WHETHER IN AN ACTION OF CONTRACT, TORT OR OTHERWISE, ARISING FROM, OUT OF OR IN CONNECTION WITH THE SOFTWARE OR THE USE OR OTHER DEALINGS IN THE SOFTWARE.

Tiff

Copyright (c) 1988-1997 Sam Leffler
Copyright (c) 1991-1997 Silicon Graphics, Inc.

Permission to use, copy, modify, distribute, and sell this software and its documentation for any purpose is hereby granted without fee, provided that (i) the above copyright notices and this permission notice appear in all copies of the software and related documentation, and (ii) the names of Sam Leffler and Silicon Graphics may not be used in any advertising or publicity relating to the software without the specific, prior written permission of Sam Leffler and Silicon Graphics.

THE SOFTWARE IS PROVIDED "AS-IS" AND WITHOUT WARRANTY OF ANY KIND, EXPRESS, IMPLIED OR OTHERWISE, INCLUDING WITHOUT LIMITATION, ANY WARRANTY OF MERCHANTABILITY OR FITNESS FOR A PARTICULAR PURPOSE.

IN NO EVENT SHALL SAM LEFFLER OR SILICON GRAPHICS BE LIABLE FOR ANY SPECIAL, INCIDENTAL, INDIRECT OR CONSEQUENTIAL DAMAGES OF ANY KIND, OR ANY DAMAGES WHATSOEVER RESULTING FROM LOSS OF USE, DATA OR PROFITS, WHETHER OR NOT ADVISED OF THE POSSIBILITY OF DAMAGE, AND ON ANY THEORY OF LIABILITY, ARISING OUT OF OR IN CONNECTION WITH THE USE OR PERFORMANCE OF THIS SOFTWARE.

Utfcpp

Boost Software License - Version 1.0 - August 17th, 2003

Permission is hereby granted, free of charge, to any person or organization obtaining a copy of the software and accompanying documentation covered by this license (the "Software") to use, reproduce, display, distribute, execute, and transmit the Software, and to prepare derivative works of the Software, and to permit third-parties to whom the Software is furnished to do so, all subject to the following:

The copyright notices in the Software and this entire statement, including the above license grant, this restriction and the following disclaimer, must be included in all copies of the Software, in whole or in part, and all derivative works of the Software, unless such copies or derivative works are solely in the form of machine-executable object code generated by a source language processor.

THE SOFTWARE IS PROVIDED "AS IS", WITHOUT WARRANTY OF ANY KIND, EXPRESS OR IMPLIED, INCLUDING BUT NOT LIMITED TO THE WARRANTIES OF MERCHANTABILITY, FITNESS FOR A PARTICULAR PURPOSE, TITLE AND NON-INFRINGEMENT. IN NO EVENT SHALL THE COPYRIGHT HOLDERS OR ANYONE DISTRIBUTING THE SOFTWARE BE LIABLE FOR ANY DAMAGES OR OTHER LIABILITY, WHETHER IN CONTRACT, TORT OR OTHERWISE, ARISING FROM, OUT OF OR IN CONNECTION WITH THE SOFTWARE OR THE USE OR OTHER DEALINGS IN THE SOFTWARE.

Vcpkg

Copyright (c) Microsoft Corporation

All rights reserved.

MIT License

Permission is hereby granted, free of charge, to any person obtaining a copy of this software and associated documentation files (the "Software"), to deal in the Software without restriction, including without limitation the rights to use, copy, modify, merge, publish, distribute, sublicense, and/or sell copies of the Software, and to permit persons to whom the Software is furnished to do so, subject to the following conditions:

The above copyright notice and this permission notice shall be included in all copies or substantial portions of the Software.

THE SOFTWARE IS PROVIDED *AS IS*, WITHOUT WARRANTY OF ANY KIND, EXPRESS OR IMPLIED, INCLUDING BUT NOT LIMITED TO THE WARRANTIES OF MERCHANTABILITY, FITNESS FOR A PARTICULAR PURPOSE AND NONINFRINGEMENT. IN NO EVENT SHALL THE AUTHORS OR COPYRIGHT HOLDERS BE LIABLE FOR ANY CLAIM, DAMAGES OR OTHER LIABILITY, WHETHER IN AN ACTION OF CONTRACT, TORT OR OTHERWISE, ARISING FROM, OUT OF OR IN CONNECTION WITH THE SOFTWARE OR THE USE OR OTHER DEALINGS IN THE SOFTWARE.

Vtk

/*=====

Program: Visualization Toolkit
Module: Copyright.txt

Copyright (c) 1993-2015 Ken Martin, Will Schroeder, Bill Lorensen
All rights reserved.

Redistribution and use in source and binary forms, with or without modification, are permitted provided that the following conditions are met:

- * Redistributions of source code must retain the above copyright notice, this list of conditions and the following disclaimer.
- * Redistributions in binary form must reproduce the above copyright notice, this list of conditions and the following disclaimer in the documentation and/or other materials provided with the distribution.
- * Neither name of Ken Martin, Will Schroeder, or Bill Lorensen nor the names of any contributors may be used to endorse or promote products derived from this software without specific prior written permission.

THIS SOFTWARE IS PROVIDED BY THE COPYRIGHT HOLDERS AND CONTRIBUTORS ``AS IS'' AND ANY EXPRESS OR IMPLIED WARRANTIES, INCLUDING, BUT NOT LIMITED TO, THE IMPLIED WARRANTIES OF MERCHANTABILITY AND FITNESS FOR A PARTICULAR PURPOSE ARE DISCLAIMED. IN NO EVENT SHALL THE AUTHORS OR CONTRIBUTORS BE LIABLE FOR ANY DIRECT, INDIRECT, INCIDENTAL, SPECIAL, EXEMPLARY, OR CONSEQUENTIAL DAMAGES (INCLUDING, BUT NOT LIMITED TO, PROCUREMENT OF SUBSTITUTE GOODS OR SERVICES; LOSS OF USE, DATA, OR PROFITS; OR BUSINESS INTERRUPTION) HOWEVER CAUSED AND ON ANY THEORY OF LIABILITY, WHETHER IN CONTRACT, STRICT LIABILITY, OR TORT (INCLUDING NEGLIGENCE OR OTHERWISE) ARISING IN ANY WAY OUT OF THE USE OF THIS SOFTWARE, EVEN IF ADVISED OF THE POSSIBILITY OF SUCH DAMAGE.

=====*/

VtkexodusII

Copyright (c) 2005-2017 National Technology & Engineering Solutions

of Sandia, LLC (NTESS). Under the terms of Contract DE-NA0003525 with NTESS, the U.S. Government retains certain rights in this software.

Redistribution and use in source and binary forms, with or without modification, are permitted provided that the following conditions are met:

- * Redistributions of source code must retain the above copyright notice, this list of conditions and the following disclaimer.
- * Redistributions in binary form must reproduce the above copyright notice, this list of conditions and the following disclaimer in the documentation and/or other materials provided with the distribution.
- * Neither the name of NTESS nor the names of its contributors may be used to endorse or promote products derived from this software without specific prior written permission.

THIS SOFTWARE IS PROVIDED BY THE COPYRIGHT HOLDERS AND CONTRIBUTORS "AS IS" AND ANY EXPRESS OR IMPLIED WARRANTIES, INCLUDING, BUT NOT LIMITED TO, THE IMPLIED WARRANTIES OF MERCHANTABILITY AND FITNESS FOR A PARTICULAR PURPOSE ARE DISCLAIMED. IN NO EVENT SHALL THE COPYRIGHT OWNER OR CONTRIBUTORS BE LIABLE FOR ANY DIRECT, INDIRECT, INCIDENTAL, SPECIAL, EXEMPLARY, OR CONSEQUENTIAL DAMAGES (INCLUDING, BUT NOT LIMITED TO, PROCUREMENT OF SUBSTITUTE GOODS OR SERVICES; LOSS OF USE, DATA, OR PROFITS; OR BUSINESS INTERRUPTION) HOWEVER CAUSED AND ON ANY THEORY OF LIABILITY, WHETHER IN CONTRACT, STRICT LIABILITY, OR TORT (INCLUDING NEGLIGENCE OR OTHERWISE) ARISING IN ANY WAY OUT OF THE USE OF THIS SOFTWARE, EVEN IF ADVISED OF THE POSSIBILITY OF SUCH DAMAGE.

Zlib

ZLIB DATA COMPRESSION LIBRARY

zlib 1.2.12 is a general purpose data compression library. All the code is thread safe. The data format used by the zlib library is described by RFCs (Request for Comments) 1950 to 1952 in the files <http://tools.ietf.org/html/rfc1950> (zlib format), [rfc1951](http://tools.ietf.org/html/rfc1951) (deflate format) and [rfc1952](http://tools.ietf.org/html/rfc1952) (gzip format).

All functions of the compression library are documented in the file `zlib.h` (volunteer to write man pages welcome, contact zlib@gzip.org). A usage example of the library is given in the file `test/example.c` which also tests that the library is working correctly. Another example is given in the file `test/minigzip.c`. The compression library itself is composed of all source files in the root directory.

To compile all files and run the test program, follow the instructions given at the top of `Makefile.in`. In short `./configure; make test`, and if that goes well, `make install` should work for most flavors of Unix. For Windows, use one of the special makefiles in `win32/` or `contrib/vstudio/`. For VMS, use `make_vms.com`.

Questions about zlib should be sent to zlib@gzip.org, or to Gilles Vollant info@winimage.com for the Windows DLL version. The zlib home page is <http://zlib.net/>. Before reporting a problem, please check this site to verify that you have the latest version of zlib; otherwise get the latest version and check whether the problem still exists or not.

PLEASE read the zlib FAQ http://zlib.net/zlib_faq.html before asking for help.

Mark Nelson markn@ieee.org wrote an article about zlib for the Jan. 1997 issue of Dr. Dobb's Journal; a copy of the article is available at <http://marknelson.us/1997/01/01/zlib-engine/>.

The changes made in version 1.2.12 are documented in the file `ChangeLog`.

Unsupported third party contributions are provided in directory `contrib/`.

zlib is available in Java using the `java.util.zip` package, documented at <http://java.sun.com/developer/technicalArticles/Programming/compression/> .

A Perl interface to zlib written by Paul Marquess <pmqs@cpan.org> is available at CPAN (Comprehensive Perl Archive Network) sites, including <http://search.cpan.org/~pmqs/IO-Compress-Zlib/> .

A Python interface to zlib written by A.M. Kuchling <amk@amk.ca> is available in Python 1.5 and later versions, see <http://docs.python.org/library/zlib.html> .

zlib is built into tcl: <http://wiki.tcl.tk/4610> .

An experimental package to read and write files in .zip format, written on top of zlib by Gilles Vollant <info@winimage.com>, is available in the `contrib/minizip` directory of zlib.

Notes for some targets:

- For Windows DLL versions, please see `win32/DLL_FAQ.txt`
- For 64-bit Irix, `deflate.c` must be compiled without any optimization. With `-O`, one `libpng` test fails. The test works in 32 bit mode (with the `-n32` compiler flag). The compiler bug has been reported to SGI.
- zlib doesn't work with `gcc 2.6.3` on a DEC 3000/300LX under OSF/1 2.1 it works when compiled with `cc`.
- On Digital Unix 4.0D (formerly OSF/1) on AlphaServer, the `cc` option `-std1` is necessary to get `gzprintf` working correctly. This is done by `configure`.
- zlib doesn't work on HP-UX 9.05 with some versions of `/bin/cc`. It works with other compilers. Use "make test" to check your compiler.
- `gzdopen` is not supported on RISCOS or BEOS.
- For PalmOs, see <http://palmzlib.sourceforge.net/>

Acknowledgments:

The deflate format used by zlib was defined by Phil Katz. The deflate and zlib specifications were written by L. Peter Deutsch. Thanks to all the people who reported problems and suggested various improvements in zlib; they are too numerous to cite here.

Copyright notice:

(C) 1995-2022 Jean-loup Gailly and Mark Adler

This software is provided 'as-is', without any express or implied warranty. In no event will the authors be held liable for any damages arising from the use of this software.

Permission is granted to anyone to use this software for any purpose, including commercial applications, and to alter it and redistribute it freely, subject to the following restrictions:

1. The origin of this software must not be misrepresented; you must not claim that you wrote the original software. If you use this software in a product, an acknowledgment in the product documentation would be appreciated but is not required.
2. Altered source versions must be plainly marked as such, and must not be misrepresented as being the original software.
3. This notice may not be removed or altered from any source distribution.

Jean-loup Gailly
jloup@zip.org

Mark Adler
madler@alumni.caltech.edu

If you use the zlib library in a product, we would appreciate *not* receiving lengthy legal documents to sign. The sources are provided for free but without warranty of any kind. The library has been entirely written by Jean-loup Gailly and Mark Adler; it does not include third-party code. We make all contributions to and distributions of this project solely in our personal capacity, and are not conveying any rights to any intellectual property of any third parties.

If you redistribute modified sources, we would appreciate that you include in the file ChangeLog history information documenting your changes. Please read the FAQ for more information on the distribution of modified source versions.

Zstd

ZSTD is dual licensed under BSD and GPLv2.

BSD License

For Zstandard software

Copyright (c) 2016-present, Facebook, Inc. All rights reserved.

Redistribution and use in source and binary forms, with or without modification, are permitted provided that the following conditions are met:

- * Redistributions of source code must retain the above copyright notice, this list of conditions and the following disclaimer.
- * Redistributions in binary form must reproduce the above copyright notice, this list of conditions and the following disclaimer in the documentation and/or other materials provided with the distribution.
- * Neither the name Facebook nor the names of its contributors may be used to endorse or promote products derived from this software without specific prior written permission.

THIS SOFTWARE IS PROVIDED BY THE COPYRIGHT HOLDERS AND CONTRIBUTORS "AS IS" AND ANY EXPRESS OR IMPLIED WARRANTIES, INCLUDING, BUT NOT LIMITED TO, THE IMPLIED WARRANTIES OF MERCHANTABILITY AND FITNESS FOR A PARTICULAR PURPOSE ARE DISCLAIMED. IN NO EVENT SHALL THE COPYRIGHT HOLDER OR CONTRIBUTORS BE LIABLE FOR ANY DIRECT, INDIRECT, INCIDENTAL, SPECIAL, EXEMPLARY, OR CONSEQUENTIAL DAMAGES (INCLUDING, BUT NOT LIMITED TO, PROCUREMENT OF SUBSTITUTE GOODS OR SERVICES; LOSS OF USE, DATA, OR PROFITS; OR BUSINESS INTERRUPTION) HOWEVER CAUSED AND ON ANY THEORY OF LIABILITY, WHETHER IN CONTRACT, STRICT LIABILITY, OR TORT (INCLUDING NEGLIGENCE OR OTHERWISE) ARISING IN ANY WAY OUT OF THE USE OF THIS SOFTWARE, EVEN IF ADVISED OF THE POSSIBILITY OF SUCH DAMAGE.

GNU GENERAL PUBLIC LICENSE Version 2, June 1991

Copyright (C) 1989, 1991 Free Software Foundation, Inc.,
51 Franklin Street, Fifth Floor, Boston, MA 02110-1301 USA
Everyone is permitted to copy and distribute verbatim copies
of this license document, but changing it is not allowed.

Preamble

The licenses for most software are designed to take away your freedom to share and change it. By contrast, the GNU General Public License is intended to guarantee your freedom to share and change free software--to make sure the software is free for all its users. This General Public License applies to most of the Free Software Foundation's software and to any other program whose authors commit to using it. (Some other Free Software Foundation software is covered by the GNU Lesser General Public License instead.) You can apply it to your programs, too.

When we speak of free software, we are referring to freedom, not price. Our General Public Licenses are designed to make sure that you have the freedom to distribute copies of free software (and charge for this service if you wish), that you receive source code or can get it if you want it, that you can change the software or use pieces of it in new free programs; and that you know you can do these things.

To protect your rights, we need to make restrictions that forbid anyone to deny you these rights or to ask you to surrender the rights. These restrictions translate to certain responsibilities for you if you distribute copies of the software, or if you modify it.

For example, if you distribute copies of such a program, whether gratis or for a fee, you must give the recipients all the rights that you have. You must make sure that they, too, receive or can get the source code. And you must show them these terms so they know their rights.

We protect your rights with two steps: (1) copyright the software, and (2) offer you this license which gives you legal permission to copy, distribute and/or modify the software.

Also, for each author's protection and ours, we want to make certain that everyone understands that there is no warranty for this free software. If the software is modified by someone else and passed on, we want its recipients to know that what they have is not the original, so that any problems introduced by others will not reflect on the original authors' reputations.

Finally, any free program is threatened constantly by software patents. We wish to avoid the danger that redistributors of a free program will individually obtain patent licenses, in effect making the program proprietary. To prevent this, we have made it clear that any patent must be licensed for everyone's free use or not licensed at all.

The precise terms and conditions for copying, distribution and modification follow.

GNU GENERAL PUBLIC LICENSE
TERMS AND CONDITIONS FOR COPYING, DISTRIBUTION AND MODIFICATION

0. This License applies to any program or other work which contains a notice placed by the copyright holder saying it may be distributed under the terms of this General Public License. The "Program", below, refers to any such program or work, and a "work based on the Program" means either the Program or any derivative work under copyright law: that is to say, a work containing the Program or a portion of it, either verbatim or with modifications and/or translated into another language. (Hereinafter, translation is included without limitation in the term "modification".) Each licensee is addressed as "you".

Activities other than copying, distribution and modification are not covered by this License; they are outside its scope. The act of running the Program is not restricted, and the output from the Program is covered only if its contents constitute a work based on the Program (independent of having been made by running the Program). Whether that is true depends on what the Program does.

1. You may copy and distribute verbatim copies of the Program's source code as you receive it, in any medium, provided that you conspicuously and appropriately publish on each copy an appropriate copyright notice and disclaimer of warranty; keep intact all the notices that refer to this License and to the absence of any warranty; and give any other recipients of the Program a copy of this License along with the Program.

You may charge a fee for the physical act of transferring a copy, and you may at your option offer warranty protection in exchange for a fee.

2. You may modify your copy or copies of the Program or any portion

of it, thus forming a work based on the Program, and copy and distribute such modifications or work under the terms of Section 1 above, provided that you also meet all of these conditions:

- a) You must cause the modified files to carry prominent notices stating that you changed the files and the date of any change.
- b) You must cause any work that you distribute or publish, that in whole or in part contains or is derived from the Program or any part thereof, to be licensed as a whole at no charge to all third parties under the terms of this License.
- c) If the modified program normally reads commands interactively when run, you must cause it, when started running for such interactive use in the most ordinary way, to print or display an announcement including an appropriate copyright notice and a notice that there is no warranty (or else, saying that you provide a warranty) and that users may redistribute the program under these conditions, and telling the user how to view a copy of this License. (Exception: if the Program itself is interactive but does not normally print such an announcement, your work based on the Program is not required to print an announcement.)

These requirements apply to the modified work as a whole. If identifiable sections of that work are not derived from the Program, and can be reasonably considered independent and separate works in themselves, then this License, and its terms, do not apply to those sections when you distribute them as separate works. But when you distribute the same sections as part of a whole which is a work based on the Program, the distribution of the whole must be on the terms of this License, whose permissions for other licensees extend to the entire whole, and thus to each and every part regardless of who wrote it.

Thus, it is not the intent of this section to claim rights or contest your rights to work written entirely by you; rather, the intent is to exercise the right to control the distribution of derivative or collective works based on the Program.

In addition, mere aggregation of another work not based on the Program with the Program (or with a work based on the Program) on a volume of a storage or distribution medium does not bring the other work under the scope of this License.

3. You may copy and distribute the Program (or a work based on it, under Section 2) in object code or executable form under the terms of Sections 1 and 2 above provided that you also do one of the following:

- a) Accompany it with the complete corresponding machine-readable source code, which must be distributed under the terms of Sections 1 and 2 above on a medium customarily used for software interchange; or,
- b) Accompany it with a written offer, valid for at least three years, to give any third party, for a charge no more than your cost of physically performing source distribution, a complete machine-readable copy of the corresponding source code, to be distributed under the terms of Sections 1 and 2 above on a medium customarily used for software interchange; or,
- c) Accompany it with the information you received as to the offer to distribute corresponding source code. (This alternative is allowed only for noncommercial distribution and only if you received the program in object code or executable form with such an offer, in accord with Subsection b above.)

The source code for a work means the preferred form of the work for making modifications to it. For an executable work, complete source code means all the source code for all modules it contains, plus any associated interface definition files, plus the scripts used to control compilation and installation of the executable. However, as a special exception, the source code distributed need not include

anything that is normally distributed (in either source or binary form) with the major components (compiler, kernel, and so on) of the operating system on which the executable runs, unless that component itself accompanies the executable.

If distribution of executable or object code is made by offering access to copy from a designated place, then offering equivalent access to copy the source code from the same place counts as distribution of the source code, even though third parties are not compelled to copy the source along with the object code.

4. You may not copy, modify, sublicense, or distribute the Program except as expressly provided under this License. Any attempt otherwise to copy, modify, sublicense or distribute the Program is void, and will automatically terminate your rights under this License. However, parties who have received copies, or rights, from you under this License will not have their licenses terminated so long as such parties remain in full compliance.

5. You are not required to accept this License, since you have not signed it. However, nothing else grants you permission to modify or distribute the Program or its derivative works. These actions are prohibited by law if you do not accept this License. Therefore, by modifying or distributing the Program (or any work based on the Program), you indicate your acceptance of this License to do so, and all its terms and conditions for copying, distributing or modifying the Program or works based on it.

6. Each time you redistribute the Program (or any work based on the Program), the recipient automatically receives a license from the original licensor to copy, distribute or modify the Program subject to these terms and conditions. You may not impose any further restrictions on the recipients' exercise of the rights granted herein. You are not responsible for enforcing compliance by third parties to this License.

7. If, as a consequence of a court judgment or allegation of patent infringement or for any other reason (not limited to patent issues), conditions are imposed on you (whether by court order, agreement or otherwise) that contradict the conditions of this License, they do not excuse you from the conditions of this License. If you cannot distribute so as to satisfy simultaneously your obligations under this License and any other pertinent obligations, then as a consequence you may not distribute the Program at all. For example, if a patent license would not permit royalty-free redistribution of the Program by all those who receive copies directly or indirectly through you, then the only way you could satisfy both it and this License would be to refrain entirely from distribution of the Program.

If any portion of this section is held invalid or unenforceable under any particular circumstance, the balance of the section is intended to apply and the section as a whole is intended to apply in other circumstances.

It is not the purpose of this section to induce you to infringe any patents or other property right claims or to contest validity of any such claims; this section has the sole purpose of protecting the integrity of the free software distribution system, which is implemented by public license practices. Many people have made generous contributions to the wide range of software distributed through that system in reliance on consistent application of that system; it is up to the author/donor to decide if he or she is willing to distribute software through any other system and a licensee cannot impose that choice.

This section is intended to make thoroughly clear what is believed to be a consequence of the rest of this License.

8. If the distribution and/or use of the Program is restricted in certain countries either by patents or by copyrighted interfaces, the

original copyright holder who places the Program under this License may add an explicit geographical distribution limitation excluding those countries, so that distribution is permitted only in or among countries not thus excluded. In such case, this License incorporates the limitation as if written in the body of this License.

9. The Free Software Foundation may publish revised and/or new versions of the General Public License from time to time. Such new versions will be similar in spirit to the present version, but may differ in detail to address new problems or concerns.

Each version is given a distinguishing version number. If the Program specifies a version number of this License which applies to it and "any later version", you have the option of following the terms and conditions either of that version or of any later version published by the Free Software Foundation. If the Program does not specify a version number of this License, you may choose any version ever published by the Free Software Foundation.

10. If you wish to incorporate parts of the Program into other free programs whose distribution conditions are different, write to the author to ask for permission. For software which is copyrighted by the Free Software Foundation, write to the Free Software Foundation; we sometimes make exceptions for this. Our decision will be guided by the two goals of preserving the free status of all derivatives of our free software and of promoting the sharing and reuse of software generally.

NO WARRANTY

11. BECAUSE THE PROGRAM IS LICENSED FREE OF CHARGE, THERE IS NO WARRANTY FOR THE PROGRAM, TO THE EXTENT PERMITTED BY APPLICABLE LAW. EXCEPT WHEN OTHERWISE STATED IN WRITING THE COPYRIGHT HOLDERS AND/OR OTHER PARTIES PROVIDE THE PROGRAM "AS IS" WITHOUT WARRANTY OF ANY KIND, EITHER EXPRESSED OR IMPLIED, INCLUDING, BUT NOT LIMITED TO, THE IMPLIED WARRANTIES OF MERCHANTABILITY AND FITNESS FOR A PARTICULAR PURPOSE. THE ENTIRE RISK AS TO THE QUALITY AND PERFORMANCE OF THE PROGRAM IS WITH YOU. SHOULD THE PROGRAM PROVE DEFECTIVE, YOU ASSUME THE COST OF ALL NECESSARY SERVICING, REPAIR OR CORRECTION.

12. IN NO EVENT UNLESS REQUIRED BY APPLICABLE LAW OR AGREED TO IN WRITING WILL ANY COPYRIGHT HOLDER, OR ANY OTHER PARTY WHO MAY MODIFY AND/OR REDISTRIBUTE THE PROGRAM AS PERMITTED ABOVE, BE LIABLE TO YOU FOR DAMAGES, INCLUDING ANY GENERAL, SPECIAL, INCIDENTAL OR CONSEQUENTIAL DAMAGES ARISING OUT OF THE USE OR INABILITY TO USE THE PROGRAM (INCLUDING BUT NOT LIMITED TO LOSS OF DATA OR DATA BEING RENDERED INACCURATE OR LOSSES SUSTAINED BY YOU OR THIRD PARTIES OR A FAILURE OF THE PROGRAM TO OPERATE WITH ANY OTHER PROGRAMS), EVEN IF SUCH HOLDER OR OTHER PARTY HAS BEEN ADVISED OF THE POSSIBILITY OF SUCH DAMAGES.

END OF TERMS AND CONDITIONS

How to Apply These Terms to Your New Programs

If you develop a new program, and you want it to be of the greatest possible use to the public, the best way to achieve this is to make it free software which everyone can redistribute and change under these terms.

To do so, attach the following notices to the program. It is safest to attach them to the start of each source file to most effectively convey the exclusion of warranty; and each file should have at least the "copyright" line and a pointer to where the full notice is found.

```
<one line to give the program's name and a brief idea of what it does.>  
Copyright (C) <year> <name of author>
```

This program is free software; you can redistribute it and/or modify it under the terms of the GNU General Public License as published by the Free Software Foundation; either version 2 of the License, or (at your option) any later version.

This program is distributed in the hope that it will be useful, but WITHOUT ANY WARRANTY; without even the implied warranty of MERCHANTABILITY or FITNESS FOR A PARTICULAR PURPOSE. See the GNU General Public License for more details.

You should have received a copy of the GNU General Public License along with this program; if not, write to the Free Software Foundation, Inc., 51 Franklin Street, Fifth Floor, Boston, MA 02110-1301 USA.

Also add information on how to contact you by electronic and paper mail.

If the program is interactive, make it output a short notice like this when it starts in an interactive mode:

```
Gnomovision version 69, Copyright (C) year name of author
Gnomovision comes with ABSOLUTELY NO WARRANTY; for details type `show w'.
This is free software, and you are welcome to redistribute it
under certain conditions; type `show c' for details.
```

The hypothetical commands `show w' and `show c' should show the appropriate parts of the General Public License. Of course, the commands you use may be called something other than `show w' and `show c'; they could even be mouse-clicks or menu items--whatever suits your program.

You should also get your employer (if you work as a programmer) or your school, if any, to sign a "copyright disclaimer" for the program, if necessary. Here is a sample; alter the names:

```
Yoyodyne, Inc., hereby disclaims all copyright interest in the program
`Gnomovision' (which makes passes at compilers) written by James Hacker.
```

```
<signature of Ty Coon>, 1 April 1989
Ty Coon, President of Vice
```

This General Public License does not permit incorporating your program into proprietary programs. If your program is a subroutine library, you may consider it more useful to permit linking proprietary applications with the library. If this is what you want to do, use the GNU Lesser General Public License instead of this License.

1.2 Open source licenses

Apache-2.0

Apache License
Version 2.0, January 2004
<http://www.apache.org/licenses/>

TERMS AND CONDITIONS FOR USE, REPRODUCTION, AND DISTRIBUTION

1. Definitions.

"License" shall mean the terms and conditions for use, reproduction, and distribution as defined by Sections 1 through 9 of this document.

"Licensor" shall mean the copyright owner or entity authorized by the copyright owner that is granting the License.

"Legal Entity" shall mean the union of the acting entity and all other entities that control, are controlled by, or are under common control with that entity. For the purposes of this definition, "control" means (i) the power, direct or indirect, to cause the direction or management of such entity, whether by contract or otherwise, or (ii) ownership of fifty percent (50%) or more of the outstanding shares, or (iii) beneficial ownership of such entity.

"You" (or "Your") shall mean an individual or Legal Entity

exercising permissions granted by this License.

"Source" form shall mean the preferred form for making modifications, including but not limited to software source code, documentation source, and configuration files.

"Object" form shall mean any form resulting from mechanical transformation or translation of a Source form, including but not limited to compiled object code, generated documentation, and conversions to other media types.

"Work" shall mean the work of authorship, whether in Source or Object form, made available under the License, as indicated by a copyright notice that is included in or attached to the work (an example is provided in the Appendix below).

"Derivative Works" shall mean any work, whether in Source or Object form, that is based on (or derived from) the Work and for which the editorial revisions, annotations, elaborations, or other modifications represent, as a whole, an original work of authorship. For the purposes of this License, Derivative Works shall not include works that remain separable from, or merely link (or bind by name) to the interfaces of, the Work and Derivative Works thereof.

"Contribution" shall mean any work of authorship, including the original version of the Work and any modifications or additions to that Work or Derivative Works thereof, that is intentionally submitted to Licensor for inclusion in the Work by the copyright owner or by an individual or Legal Entity authorized to submit on behalf of the copyright owner. For the purposes of this definition, "submitted" means any form of electronic, verbal, or written communication sent to the Licensor or its representatives, including but not limited to communication on electronic mailing lists, source code control systems, and issue tracking systems that are managed by, or on behalf of, the Licensor for the purpose of discussing and improving the Work, but excluding communication that is conspicuously marked or otherwise designated in writing by the copyright owner as "Not a Contribution."

"Contributor" shall mean Licensor and any individual or Legal Entity on behalf of whom a Contribution has been received by Licensor and subsequently incorporated within the Work.

2. Grant of Copyright License. Subject to the terms and conditions of this License, each Contributor hereby grants to You a perpetual, worldwide, non-exclusive, no-charge, royalty-free, irrevocable copyright license to reproduce, prepare Derivative Works of, publicly display, publicly perform, sublicense, and distribute the Work and such Derivative Works in Source or Object form.
3. Grant of Patent License. Subject to the terms and conditions of this License, each Contributor hereby grants to You a perpetual, worldwide, non-exclusive, no-charge, royalty-free, irrevocable (except as stated in this section) patent license to make, have made, use, offer to sell, sell, import, and otherwise transfer the Work, where such license applies only to those patent claims licensable by such Contributor that are necessarily infringed by their Contribution(s) alone or by combination of their Contribution(s) with the Work to which such Contribution(s) was submitted. If You institute patent litigation against any entity (including a cross-claim or counterclaim in a lawsuit) alleging that the Work or a Contribution incorporated within the Work constitutes direct or contributory patent infringement, then any patent licenses granted to You under this License for that Work shall terminate as of the date such litigation is filed.
4. Redistribution. You may reproduce and distribute copies of the Work or Derivative Works thereof in any medium, with or without modifications, and in Source or Object form, provided that You meet the following conditions:

- (a) You must give any other recipients of the Work or Derivative Works a copy of this License; and
- (b) You must cause any modified files to carry prominent notices stating that You changed the files; and
- (c) You must retain, in the Source form of any Derivative Works that You distribute, all copyright, patent, trademark, and attribution notices from the Source form of the Work, excluding those notices that do not pertain to any part of the Derivative Works; and
- (d) If the Work includes a "NOTICE" text file as part of its distribution, then any Derivative Works that You distribute must include a readable copy of the attribution notices contained within such NOTICE file, excluding those notices that do not pertain to any part of the Derivative Works, in at least one of the following places: within a NOTICE text file distributed as part of the Derivative Works; within the Source form or documentation, if provided along with the Derivative Works; or, within a display generated by the Derivative Works, if and wherever such third-party notices normally appear. The contents of the NOTICE file are for informational purposes only and do not modify the License. You may add Your own attribution notices within Derivative Works that You distribute, alongside or as an addendum to the NOTICE text from the Work, provided that such additional attribution notices cannot be construed as modifying the License.

You may add Your own copyright statement to Your modifications and may provide additional or different license terms and conditions for use, reproduction, or distribution of Your modifications, or for any such Derivative Works as a whole, provided Your use, reproduction, and distribution of the Work otherwise complies with the conditions stated in this License.

- 5. Submission of Contributions. Unless You explicitly state otherwise, any Contribution intentionally submitted for inclusion in the Work by You to the Licensor shall be under the terms and conditions of this License, without any additional terms or conditions. Notwithstanding the above, nothing herein shall supersede or modify the terms of any separate license agreement you may have executed with Licensor regarding such Contributions.
- 6. Trademarks. This License does not grant permission to use the trade names, trademarks, service marks, or product names of the Licensor, except as required for reasonable and customary use in describing the origin of the Work and reproducing the content of the NOTICE file.
- 7. Disclaimer of Warranty. Unless required by applicable law or agreed to in writing, Licensor provides the Work (and each Contributor provides its Contributions) on an "AS IS" BASIS, WITHOUT WARRANTIES OR CONDITIONS OF ANY KIND, either express or implied, including, without limitation, any warranties or conditions of TITLE, NON-INFRINGEMENT, MERCHANTABILITY, or FITNESS FOR A PARTICULAR PURPOSE. You are solely responsible for determining the appropriateness of using or redistributing the Work and assume any risks associated with Your exercise of permissions under this License.
- 8. Limitation of Liability. In no event and under no legal theory, whether in tort (including negligence), contract, or otherwise, unless required by applicable law (such as deliberate and grossly negligent acts) or agreed to in writing, shall any Contributor be liable to You for damages, including any direct, indirect, special, incidental, or consequential damages of any character arising as a result of this License or out of the use or inability to use the Work (including but not limited to damages for loss of goodwill, work stoppage, computer failure or malfunction, or any and all other commercial damages or losses), even if such Contributor has been advised of the possibility of such damages.

9. Accepting Warranty or Additional Liability. While redistributing the Work or Derivative Works thereof, You may choose to offer, and charge a fee for, acceptance of support, warranty, indemnity, or other liability obligations and/or rights consistent with this License. However, in accepting such obligations, You may act only on Your own behalf and on Your sole responsibility, not on behalf of any other Contributor, and only if You agree to indemnify, defend, and hold each Contributor harmless for any liability incurred by, or claims asserted against, such Contributor by reason of your accepting any such warranty or additional liability.

END OF TERMS AND CONDITIONS

APPENDIX: How to apply the Apache License to your work.

To apply the Apache License to your work, attach the following boilerplate notice, with the fields enclosed by brackets "[]" replaced with your own identifying information. (Don't include the brackets!) The text should be enclosed in the appropriate comment syntax for the file format. We also recommend that a file or class name and description of purpose be included on the same "printed page" as the copyright notice for easier identification within third-party archives.

Copyright [yyyy] [name of copyright owner]

Licensed under the Apache License, Version 2.0 (the "License");
you may not use this file except in compliance with the License.
You may obtain a copy of the License at

<http://www.apache.org/licenses/LICENSE-2.0>

Unless required by applicable law or agreed to in writing, software distributed under the License is distributed on an "AS IS" BASIS, WITHOUT WARRANTIES OR CONDITIONS OF ANY KIND, either express or implied. See the License for the specific language governing permissions and limitations under the License.

FTL

The FreeType Project LICENSE

2006-Jan-27

Copyright 1996-2002, 2006 by
David Turner, Robert Wilhelm, and Werner Lemberg

Introduction

=====

The FreeType Project is distributed in several archive packages; some of them may contain, in addition to the FreeType font engine, various tools and contributions which rely on, or relate to, the FreeType Project.

This license applies to all files found in such packages, and which do not fall under their own explicit license. The license affects thus the FreeType font engine, the test programs, documentation and makefiles, at the very least.

This license was inspired by the BSD, Artistic, and IJG (Independent JPEG Group) licenses, which all encourage inclusion and use of free software in commercial and freeware products alike. As a consequence, its main points are that:

- o We don't promise that this software works. However, we will be interested in any kind of bug reports. ('as is' distribution)
- o You can use this software for whatever you want, in parts or full form, without having to pay us. ('royalty-free' usage)
- o You may not pretend that you wrote this software. If you use it, or only parts of it, in a program, you must acknowledge somewhere in your documentation that you have used the FreeType code. ('credits')

We specifically permit and encourage the inclusion of this software, with or without modifications, in commercial products. We disclaim all warranties covering The FreeType Project and assume no liability related to The FreeType Project.

Finally, many people asked us for a preferred form for a credit/disclaimer to use in compliance with this license. We thus encourage you to use the following text:

```

"""
Portions of this software are copyright © <year> The FreeType
Project (www.freetype.org). All rights reserved.
"""

```

Please replace <year> with the value from the FreeType version you actually use.

Legal Terms =====

0. Definitions -----

Throughout this license, the terms 'package', 'FreeType Project', and 'FreeType archive' refer to the set of files originally distributed by the authors (David Turner, Robert Wilhelm, and Werner Lemberg) as the 'FreeType Project', be they named as alpha, beta or final release.

'You' refers to the licensee, or person using the project, where 'using' is a generic term including compiling the project's source code as well as linking it to form a 'program' or 'executable'. This program is referred to as 'a program using the FreeType engine'.

This license applies to all files distributed in the original FreeType Project, including all source code, binaries and documentation, unless otherwise stated in the file in its original, unmodified form as distributed in the original archive. If you are unsure whether or not a particular file is covered by this license, you must contact us to verify this.

The FreeType Project is copyright (C) 1996-2000 by David Turner, Robert Wilhelm, and Werner Lemberg. All rights reserved except as specified below.

1. No Warranty -----

THE FREETYPE PROJECT IS PROVIDED 'AS IS' WITHOUT WARRANTY OF ANY KIND, EITHER EXPRESS OR IMPLIED, INCLUDING, BUT NOT LIMITED TO, WARRANTIES OF MERCHANTABILITY AND FITNESS FOR A PARTICULAR PURPOSE. IN NO EVENT WILL ANY OF THE AUTHORS OR COPYRIGHT HOLDERS BE LIABLE FOR ANY DAMAGES CAUSED BY THE USE OR THE INABILITY TO USE, OF THE FREETYPE PROJECT.

2. Redistribution

This license grants a worldwide, royalty-free, perpetual and irrevocable right and license to use, execute, perform, compile, display, copy, create derivative works of, distribute and sublicense the FreeType Project (in both source and object code forms) and derivative works thereof for any purpose; and to authorize others to exercise some or all of the rights granted herein, subject to the following conditions:

- o Redistribution of source code must retain this license file (``FTL.TXT'`) unaltered; any additions, deletions or changes to the original files must be clearly indicated in accompanying documentation. The copyright notices of the unaltered, original files must be preserved in all copies of source files.
- o Redistribution in binary form must provide a disclaimer that states that the software is based in part of the work of the FreeType Team, in the distribution documentation. We also encourage you to put an URL to the FreeType web page in your documentation, though this isn't mandatory.

These conditions apply to any software derived from or based on the FreeType Project, not just the unmodified files. If you use our work, you must acknowledge us. However, no fee need be paid to us.

3. Advertising

Neither the FreeType authors and contributors nor you shall use the name of the other for commercial, advertising, or promotional purposes without specific prior written permission.

We suggest, but do not require, that you use one or more of the following phrases to refer to this software in your documentation or advertising materials: ``FreeType Project'`, ``FreeType Engine'`, ``FreeType library'`, or ``FreeType Distribution'`.

As you have not signed this license, you are not required to accept it. However, as the FreeType Project is copyrighted material, only this license, or another one contracted with the authors, grants you the right to use, distribute, and modify it. Therefore, by using, distributing, or modifying the FreeType Project, you indicate that you understand and accept all the terms of this license.

4. Contacts

There are two mailing lists related to FreeType:

- o `freetype@nongnu.org`
Discusses general use and applications of FreeType, as well as future and wanted additions to the library and distribution. If you are looking for support, start in this list if you haven't found anything to help you in the documentation.
- o `freetype-devel@nongnu.org`
Discusses bugs, as well as engine internals, design issues, specific licenses, porting, etc.

Our home page can be found at

<https://www.freetype.org>

GPL-2.0

GNU GENERAL PUBLIC LICENSE
Version 2, June 1991

Copyright (C) 1989, 1991 Free Software Foundation, Inc.,
51 Franklin Street, Fifth Floor, Boston, MA 02110-1301 USA
Everyone is permitted to copy and distribute verbatim copies
of this license document, but changing it is not allowed.

Preamble

The licenses for most software are designed to take away your freedom to share and change it. By contrast, the GNU General Public License is intended to guarantee your freedom to share and change free software--to make sure the software is free for all its users. This General Public License applies to most of the Free Software Foundation's software and to any other program whose authors commit to using it. (Some other Free Software Foundation software is covered by the GNU Lesser General Public License instead.) You can apply it to your programs, too.

When we speak of free software, we are referring to freedom, not price. Our General Public Licenses are designed to make sure that you have the freedom to distribute copies of free software (and charge for this service if you wish), that you receive source code or can get it if you want it, that you can change the software or use pieces of it in new free programs; and that you know you can do these things.

To protect your rights, we need to make restrictions that forbid anyone to deny you these rights or to ask you to surrender the rights. These restrictions translate to certain responsibilities for you if you distribute copies of the software, or if you modify it.

For example, if you distribute copies of such a program, whether gratis or for a fee, you must give the recipients all the rights that you have. You must make sure that they, too, receive or can get the source code. And you must show them these terms so they know their rights.

We protect your rights with two steps: (1) copyright the software, and (2) offer you this license which gives you legal permission to copy, distribute and/or modify the software.

Also, for each author's protection and ours, we want to make certain that everyone understands that there is no warranty for this free software. If the software is modified by someone else and passed on, we want its recipients to know that what they have is not the original, so that any problems introduced by others will not reflect on the original authors' reputations.

Finally, any free program is threatened constantly by software patents. We wish to avoid the danger that redistributors of a free program will individually obtain patent licenses, in effect making the program proprietary. To prevent this, we have made it clear that any patent must be licensed for everyone's free use or not licensed at all.

The precise terms and conditions for copying, distribution and modification follow.

GNU GENERAL PUBLIC LICENSE
TERMS AND CONDITIONS FOR COPYING, DISTRIBUTION AND MODIFICATION

0. This License applies to any program or other work which contains a notice placed by the copyright holder saying it may be distributed under the terms of this General Public License. The "Program", below, refers to any such program or work, and a "work based on the Program" means either the Program or any derivative work under copyright law: that is to say, a work containing the Program or a portion of it, either verbatim or with modifications and/or translated into another language. (Hereinafter, translation is included without limitation in the term "modification".) Each licensee is addressed as "you".

Activities other than copying, distribution and modification are not covered by this License; they are outside its scope. The act of running the Program is not restricted, and the output from the Program is covered only if its contents constitute a work based on the Program (independent of having been made by running the Program). Whether that is true depends on what the Program does.

1. You may copy and distribute verbatim copies of the Program's source code as you receive it, in any medium, provided that you conspicuously and appropriately publish on each copy an appropriate copyright notice and disclaimer of warranty; keep intact all the notices that refer to this License and to the absence of any warranty; and give any other recipients of the Program a copy of this License along with the Program.

You may charge a fee for the physical act of transferring a copy, and you may at your option offer warranty protection in exchange for a fee.

2. You may modify your copy or copies of the Program or any portion of it, thus forming a work based on the Program, and copy and distribute such modifications or work under the terms of Section 1 above, provided that you also meet all of these conditions:

- a) You must cause the modified files to carry prominent notices stating that you changed the files and the date of any change.
- b) You must cause any work that you distribute or publish, that in whole or in part contains or is derived from the Program or any part thereof, to be licensed as a whole at no charge to all third parties under the terms of this License.
- c) If the modified program normally reads commands interactively when run, you must cause it, when started running for such interactive use in the most ordinary way, to print or display an announcement including an appropriate copyright notice and a notice that there is no warranty (or else, saying that you provide a warranty) and that users may redistribute the program under these conditions, and telling the user how to view a copy of this License. (Exception: if the Program itself is interactive but does not normally print such an announcement, your work based on the Program is not required to print an announcement.)

These requirements apply to the modified work as a whole. If identifiable sections of that work are not derived from the Program, and can be reasonably considered independent and separate works in themselves, then this License, and its terms, do not apply to those sections when you distribute them as separate works. But when you distribute the same sections as part of a whole which is a work based on the Program, the distribution of the whole must be on the terms of this License, whose permissions for other licensees extend to the entire whole, and thus to each and every part regardless of who wrote it.

Thus, it is not the intent of this section to claim rights or contest your rights to work written entirely by you; rather, the intent is to exercise the right to control the distribution of derivative or collective works based on the Program.

In addition, mere aggregation of another work not based on the Program with the Program (or with a work based on the Program) on a volume of a storage or distribution medium does not bring the other work under the scope of this License.

3. You may copy and distribute the Program (or a work based on it, under Section 2) in object code or executable form under the terms of Sections 1 and 2 above provided that you also do one of the following:

- a) Accompany it with the complete corresponding machine-readable source code, which must be distributed under the terms of Sections 1 and 2 above on a medium customarily used for software interchange; or,

b) Accompany it with a written offer, valid for at least three years, to give any third party, for a charge no more than your cost of physically performing source distribution, a complete machine-readable copy of the corresponding source code, to be distributed under the terms of Sections 1 and 2 above on a medium customarily used for software interchange; or,

c) Accompany it with the information you received as to the offer to distribute corresponding source code. (This alternative is allowed only for noncommercial distribution and only if you received the program in object code or executable form with such an offer, in accord with Subsection b above.)

The source code for a work means the preferred form of the work for making modifications to it. For an executable work, complete source code means all the source code for all modules it contains, plus any associated interface definition files, plus the scripts used to control compilation and installation of the executable. However, as a special exception, the source code distributed need not include anything that is normally distributed (in either source or binary form) with the major components (compiler, kernel, and so on) of the operating system on which the executable runs, unless that component itself accompanies the executable.

If distribution of executable or object code is made by offering access to copy from a designated place, then offering equivalent access to copy the source code from the same place counts as distribution of the source code, even though third parties are not compelled to copy the source along with the object code.

4. You may not copy, modify, sublicense, or distribute the Program except as expressly provided under this License. Any attempt otherwise to copy, modify, sublicense or distribute the Program is void, and will automatically terminate your rights under this License. However, parties who have received copies, or rights, from you under this License will not have their licenses terminated so long as such parties remain in full compliance.

5. You are not required to accept this License, since you have not signed it. However, nothing else grants you permission to modify or distribute the Program or its derivative works. These actions are prohibited by law if you do not accept this License. Therefore, by modifying or distributing the Program (or any work based on the Program), you indicate your acceptance of this License to do so, and all its terms and conditions for copying, distributing or modifying the Program or works based on it.

6. Each time you redistribute the Program (or any work based on the Program), the recipient automatically receives a license from the original licensor to copy, distribute or modify the Program subject to these terms and conditions. You may not impose any further restrictions on the recipients' exercise of the rights granted herein. You are not responsible for enforcing compliance by third parties to this License.

7. If, as a consequence of a court judgment or allegation of patent infringement or for any other reason (not limited to patent issues), conditions are imposed on you (whether by court order, agreement or otherwise) that contradict the conditions of this License, they do not excuse you from the conditions of this License. If you cannot distribute so as to satisfy simultaneously your obligations under this License and any other pertinent obligations, then as a consequence you may not distribute the Program at all. For example, if a patent license would not permit royalty-free redistribution of the Program by all those who receive copies directly or indirectly through you, then the only way you could satisfy both it and this License would be to refrain entirely from distribution of the Program.

If any portion of this section is held invalid or unenforceable under

any particular circumstance, the balance of the section is intended to apply and the section as a whole is intended to apply in other circumstances.

It is not the purpose of this section to induce you to infringe any patents or other property right claims or to contest validity of any such claims; this section has the sole purpose of protecting the integrity of the free software distribution system, which is implemented by public license practices. Many people have made generous contributions to the wide range of software distributed through that system in reliance on consistent application of that system; it is up to the author/donor to decide if he or she is willing to distribute software through any other system and a licensee cannot impose that choice.

This section is intended to make thoroughly clear what is believed to be a consequence of the rest of this License.

8. If the distribution and/or use of the Program is restricted in certain countries either by patents or by copyrighted interfaces, the original copyright holder who places the Program under this License may add an explicit geographical distribution limitation excluding those countries, so that distribution is permitted only in or among countries not thus excluded. In such case, this License incorporates the limitation as if written in the body of this License.

9. The Free Software Foundation may publish revised and/or new versions of the General Public License from time to time. Such new versions will be similar in spirit to the present version, but may differ in detail to address new problems or concerns.

Each version is given a distinguishing version number. If the Program specifies a version number of this License which applies to it and "any later version", you have the option of following the terms and conditions either of that version or of any later version published by the Free Software Foundation. If the Program does not specify a version number of this License, you may choose any version ever published by the Free Software Foundation.

10. If you wish to incorporate parts of the Program into other free programs whose distribution conditions are different, write to the author to ask for permission. For software which is copyrighted by the Free Software Foundation, write to the Free Software Foundation; we sometimes make exceptions for this. Our decision will be guided by the two goals of preserving the free status of all derivatives of our free software and of promoting the sharing and reuse of software generally.

NO WARRANTY

11. BECAUSE THE PROGRAM IS LICENSED FREE OF CHARGE, THERE IS NO WARRANTY FOR THE PROGRAM, TO THE EXTENT PERMITTED BY APPLICABLE LAW. EXCEPT WHEN OTHERWISE STATED IN WRITING THE COPYRIGHT HOLDERS AND/OR OTHER PARTIES PROVIDE THE PROGRAM "AS IS" WITHOUT WARRANTY OF ANY KIND, EITHER EXPRESSED OR IMPLIED, INCLUDING, BUT NOT LIMITED TO, THE IMPLIED WARRANTIES OF MERCHANTABILITY AND FITNESS FOR A PARTICULAR PURPOSE. THE ENTIRE RISK AS TO THE QUALITY AND PERFORMANCE OF THE PROGRAM IS WITH YOU. SHOULD THE PROGRAM PROVE DEFECTIVE, YOU ASSUME THE COST OF ALL NECESSARY SERVICING, REPAIR OR CORRECTION.

12. IN NO EVENT UNLESS REQUIRED BY APPLICABLE LAW OR AGREED TO IN WRITING WILL ANY COPYRIGHT HOLDER, OR ANY OTHER PARTY WHO MAY MODIFY AND/OR REDISTRIBUTE THE PROGRAM AS PERMITTED ABOVE, BE LIABLE TO YOU FOR DAMAGES, INCLUDING ANY GENERAL, SPECIAL, INCIDENTAL OR CONSEQUENTIAL DAMAGES ARISING OUT OF THE USE OR INABILITY TO USE THE PROGRAM (INCLUDING BUT NOT LIMITED TO LOSS OF DATA OR DATA BEING RENDERED INACCURATE OR LOSSES SUSTAINED BY YOU OR THIRD PARTIES OR A FAILURE OF THE PROGRAM TO OPERATE WITH ANY OTHER PROGRAMS), EVEN IF SUCH HOLDER OR OTHER PARTY HAS BEEN ADVISED OF THE POSSIBILITY OF SUCH DAMAGES.

END OF TERMS AND CONDITIONS

How to Apply These Terms to Your New Programs

If you develop a new program, and you want it to be of the greatest possible use to the public, the best way to achieve this is to make it free software which everyone can redistribute and change under these terms.

To do so, attach the following notices to the program. It is safest to attach them to the start of each source file to most effectively convey the exclusion of warranty; and each file should have at least the "copyright" line and a pointer to where the full notice is found.

```
<one line to give the program's name and a brief idea of what it does.>
Copyright (C) <year> <name of author>
```

```
This program is free software; you can redistribute it and/or modify
it under the terms of the GNU General Public License as published by
the Free Software Foundation; either version 2 of the License, or
(at your option) any later version.
```

```
This program is distributed in the hope that it will be useful,
but WITHOUT ANY WARRANTY; without even the implied warranty of
MERCHANTABILITY or FITNESS FOR A PARTICULAR PURPOSE. See the
GNU General Public License for more details.
```

```
You should have received a copy of the GNU General Public License along
with this program; if not, write to the Free Software Foundation, Inc.,
51 Franklin Street, Fifth Floor, Boston, MA 02110-1301 USA.
```

Also add information on how to contact you by electronic and paper mail.

If the program is interactive, make it output a short notice like this when it starts in an interactive mode:

```
Gnomovision version 69, Copyright (C) year name of author
Gnomovision comes with ABSOLUTELY NO WARRANTY; for details type `show w'.
This is free software, and you are welcome to redistribute it
under certain conditions; type `show c' for details.
```

The hypothetical commands `show w' and `show c' should show the appropriate parts of the General Public License. Of course, the commands you use may be called something other than `show w' and `show c'; they could even be mouse-clicks or menu items--whatever suits your program.

You should also get your employer (if you work as a programmer) or your school, if any, to sign a "copyright disclaimer" for the program, if necessary. Here is a sample; alter the names:

```
Yoyodyne, Inc., hereby disclaims all copyright interest in the program
`Gnomovision' (which makes passes at compilers) written by James Hacker.
```

```
<signature of Ty Coon>, 1 April 1989
Ty Coon, President of Vice
```

This General Public License does not permit incorporating your program into proprietary programs. If your program is a subroutine library, you may consider it more useful to permit linking proprietary applications with the library. If this is what you want to do, use the GNU Lesser General Public License instead of this License.

GPL-3.0

GNU GENERAL PUBLIC LICENSE
Version 3, 29 June 2007

Copyright (C) 2007 Free Software Foundation, Inc. <<https://fsf.org/>>
Everyone is permitted to copy and distribute verbatim copies
of this license document, but changing it is not allowed.

Preamble

The GNU General Public License is a free, copyleft license for software and other kinds of works.

The licenses for most software and other practical works are designed to take away your freedom to share and change the works. By contrast, the GNU General Public License is intended to guarantee your freedom to share and change all versions of a program--to make sure it remains free software for all its users. We, the Free Software Foundation, use the GNU General Public License for most of our software; it applies also to any other work released this way by its authors. You can apply it to your programs, too.

When we speak of free software, we are referring to freedom, not price. Our General Public Licenses are designed to make sure that you have the freedom to distribute copies of free software (and charge for them if you wish), that you receive source code or can get it if you want it, that you can change the software or use pieces of it in new free programs, and that you know you can do these things.

To protect your rights, we need to prevent others from denying you these rights or asking you to surrender the rights. Therefore, you have certain responsibilities if you distribute copies of the software, or if you modify it: responsibilities to respect the freedom of others.

For example, if you distribute copies of such a program, whether gratis or for a fee, you must pass on to the recipients the same freedoms that you received. You must make sure that they, too, receive or can get the source code. And you must show them these terms so they know their rights.

Developers that use the GNU GPL protect your rights with two steps: (1) assert copyright on the software, and (2) offer you this License giving you legal permission to copy, distribute and/or modify it.

For the developers' and authors' protection, the GPL clearly explains that there is no warranty for this free software. For both users' and authors' sake, the GPL requires that modified versions be marked as changed, so that their problems will not be attributed erroneously to authors of previous versions.

Some devices are designed to deny users access to install or run modified versions of the software inside them, although the manufacturer can do so. This is fundamentally incompatible with the aim of protecting users' freedom to change the software. The systematic pattern of such abuse occurs in the area of products for individuals to use, which is precisely where it is most unacceptable. Therefore, we have designed this version of the GPL to prohibit the practice for those products. If such problems arise substantially in other domains, we stand ready to extend this provision to those domains in future versions of the GPL, as needed to protect the freedom of users.

Finally, every program is threatened constantly by software patents. States should not allow patents to restrict development and use of software on general-purpose computers, but in those that do, we wish to avoid the special danger that patents applied to a free program could make it effectively proprietary. To prevent this, the GPL assures that patents cannot be used to render the program non-free.

The precise terms and conditions for copying, distribution and modification follow.

TERMS AND CONDITIONS

0. Definitions.

"This License" refers to version 3 of the GNU General Public License.

"Copyright" also means copyright-like laws that apply to other kinds of

works, such as semiconductor masks.

"The Program" refers to any copyrightable work licensed under this License. Each licensee is addressed as "you". "Licensees" and "recipients" may be individuals or organizations.

To "modify" a work means to copy from or adapt all or part of the work in a fashion requiring copyright permission, other than the making of an exact copy. The resulting work is called a "modified version" of the earlier work or a work "based on" the earlier work.

A "covered work" means either the unmodified Program or a work based on the Program.

To "propagate" a work means to do anything with it that, without permission, would make you directly or secondarily liable for infringement under applicable copyright law, except executing it on a computer or modifying a private copy. Propagation includes copying, distribution (with or without modification), making available to the public, and in some countries other activities as well.

To "convey" a work means any kind of propagation that enables other parties to make or receive copies. Mere interaction with a user through a computer network, with no transfer of a copy, is not conveying.

An interactive user interface displays "Appropriate Legal Notices" to the extent that it includes a convenient and prominently visible feature that (1) displays an appropriate copyright notice, and (2) tells the user that there is no warranty for the work (except to the extent that warranties are provided), that licensees may convey the work under this License, and how to view a copy of this License. If the interface presents a list of user commands or options, such as a menu, a prominent item in the list meets this criterion.

1. Source Code.

The "source code" for a work means the preferred form of the work for making modifications to it. "Object code" means any non-source form of a work.

A "Standard Interface" means an interface that either is an official standard defined by a recognized standards body, or, in the case of interfaces specified for a particular programming language, one that is widely used among developers working in that language.

The "System Libraries" of an executable work include anything, other than the work as a whole, that (a) is included in the normal form of packaging a Major Component, but which is not part of that Major Component, and (b) serves only to enable use of the work with that Major Component, or to implement a Standard Interface for which an implementation is available to the public in source code form. A "Major Component", in this context, means a major essential component (kernel, window system, and so on) of the specific operating system (if any) on which the executable work runs, or a compiler used to produce the work, or an object code interpreter used to run it.

The "Corresponding Source" for a work in object code form means all the source code needed to generate, install, and (for an executable work) run the object code and to modify the work, including scripts to control those activities. However, it does not include the work's System Libraries, or general-purpose tools or generally available free programs which are used unmodified in performing those activities but which are not part of the work. For example, Corresponding Source includes interface definition files associated with source files for the work, and the source code for shared libraries and dynamically linked subprograms that the work is specifically designed to require, such as by intimate data communication or control flow between those subprograms and other parts of the work.

The Corresponding Source need not include anything that users

can regenerate automatically from other parts of the Corresponding Source.

The Corresponding Source for a work in source code form is that same work.

2. Basic Permissions.

All rights granted under this License are granted for the term of copyright on the Program, and are irrevocable provided the stated conditions are met. This License explicitly affirms your unlimited permission to run the unmodified Program. The output from running a covered work is covered by this License only if the output, given its content, constitutes a covered work. This License acknowledges your rights of fair use or other equivalent, as provided by copyright law.

You may make, run and propagate covered works that you do not convey, without conditions so long as your license otherwise remains in force. You may convey covered works to others for the sole purpose of having them make modifications exclusively for you, or provide you with facilities for running those works, provided that you comply with the terms of this License in conveying all material for which you do not control copyright. Those thus making or running the covered works for you must do so exclusively on your behalf, under your direction and control, on terms that prohibit them from making any copies of your copyrighted material outside their relationship with you.

Conveying under any other circumstances is permitted solely under the conditions stated below. Sublicensing is not allowed; section 10 makes it unnecessary.

3. Protecting Users' Legal Rights From Anti-Circumvention Law.

No covered work shall be deemed part of an effective technological measure under any applicable law fulfilling obligations under article 11 of the WIPO copyright treaty adopted on 20 December 1996, or similar laws prohibiting or restricting circumvention of such measures.

When you convey a covered work, you waive any legal power to forbid circumvention of technological measures to the extent such circumvention is effected by exercising rights under this License with respect to the covered work, and you disclaim any intention to limit operation or modification of the work as a means of enforcing, against the work's users, your or third parties' legal rights to forbid circumvention of technological measures.

4. Conveying Verbatim Copies.

You may convey verbatim copies of the Program's source code as you receive it, in any medium, provided that you conspicuously and appropriately publish on each copy an appropriate copyright notice; keep intact all notices stating that this License and any non-permissive terms added in accord with section 7 apply to the code; keep intact all notices of the absence of any warranty; and give all recipients a copy of this License along with the Program.

You may charge any price or no price for each copy that you convey, and you may offer support or warranty protection for a fee.

5. Conveying Modified Source Versions.

You may convey a work based on the Program, or the modifications to produce it from the Program, in the form of source code under the terms of section 4, provided that you also meet all of these conditions:

- a) The work must carry prominent notices stating that you modified it, and giving a relevant date.
- b) The work must carry prominent notices stating that it is

released under this License and any conditions added under section 7. This requirement modifies the requirement in section 4 to "keep intact all notices".

c) You must license the entire work, as a whole, under this License to anyone who comes into possession of a copy. This License will therefore apply, along with any applicable section 7 additional terms, to the whole of the work, and all its parts, regardless of how they are packaged. This License gives no permission to license the work in any other way, but it does not invalidate such permission if you have separately received it.

d) If the work has interactive user interfaces, each must display Appropriate Legal Notices; however, if the Program has interactive interfaces that do not display Appropriate Legal Notices, your work need not make them do so.

A compilation of a covered work with other separate and independent works, which are not by their nature extensions of the covered work, and which are not combined with it such as to form a larger program, in or on a volume of a storage or distribution medium, is called an "aggregate" if the compilation and its resulting copyright are not used to limit the access or legal rights of the compilation's users beyond what the individual works permit. Inclusion of a covered work in an aggregate does not cause this License to apply to the other parts of the aggregate.

6. Conveying Non-Source Forms.

You may convey a covered work in object code form under the terms of sections 4 and 5, provided that you also convey the machine-readable Corresponding Source under the terms of this License, in one of these ways:

a) Convey the object code in, or embodied in, a physical product (including a physical distribution medium), accompanied by the Corresponding Source fixed on a durable physical medium customarily used for software interchange.

b) Convey the object code in, or embodied in, a physical product (including a physical distribution medium), accompanied by a written offer, valid for at least three years and valid for as long as you offer spare parts or customer support for that product model, to give anyone who possesses the object code either (1) a copy of the Corresponding Source for all the software in the product that is covered by this License, on a durable physical medium customarily used for software interchange, for a price no more than your reasonable cost of physically performing this conveying of source, or (2) access to copy the Corresponding Source from a network server at no charge.

c) Convey individual copies of the object code with a copy of the written offer to provide the Corresponding Source. This alternative is allowed only occasionally and noncommercially, and only if you received the object code with such an offer, in accord with subsection 6b.

d) Convey the object code by offering access from a designated place (gratis or for a charge), and offer equivalent access to the Corresponding Source in the same way through the same place at no further charge. You need not require recipients to copy the Corresponding Source along with the object code. If the place to copy the object code is a network server, the Corresponding Source may be on a different server (operated by you or a third party) that supports equivalent copying facilities, provided you maintain clear directions next to the object code saying where to find the Corresponding Source. Regardless of what server hosts the Corresponding Source, you remain obligated to ensure that it is available for as long as needed to satisfy these requirements.

e) Convey the object code using peer-to-peer transmission, provided you inform other peers where the object code and Corresponding Source of the work are being offered to the general public at no charge under subsection 6d.

A separable portion of the object code, whose source code is excluded from the Corresponding Source as a System Library, need not be included in conveying the object code work.

A "User Product" is either (1) a "consumer product", which means any tangible personal property which is normally used for personal, family, or household purposes, or (2) anything designed or sold for incorporation into a dwelling. In determining whether a product is a consumer product, doubtful cases shall be resolved in favor of coverage. For a particular product received by a particular user, "normally used" refers to a typical or common use of that class of product, regardless of the status of the particular user or of the way in which the particular user actually uses, or expects or is expected to use, the product. A product is a consumer product regardless of whether the product has substantial commercial, industrial or non-consumer uses, unless such uses represent the only significant mode of use of the product.

"Installation Information" for a User Product means any methods, procedures, authorization keys, or other information required to install and execute modified versions of a covered work in that User Product from a modified version of its Corresponding Source. The information must suffice to ensure that the continued functioning of the modified object code is in no case prevented or interfered with solely because modification has been made.

If you convey an object code work under this section in, or with, or specifically for use in, a User Product, and the conveying occurs as part of a transaction in which the right of possession and use of the User Product is transferred to the recipient in perpetuity or for a fixed term (regardless of how the transaction is characterized), the Corresponding Source conveyed under this section must be accompanied by the Installation Information. But this requirement does not apply if neither you nor any third party retains the ability to install modified object code on the User Product (for example, the work has been installed in ROM).

The requirement to provide Installation Information does not include a requirement to continue to provide support service, warranty, or updates for a work that has been modified or installed by the recipient, or for the User Product in which it has been modified or installed. Access to a network may be denied when the modification itself materially and adversely affects the operation of the network or violates the rules and protocols for communication across the network.

Corresponding Source conveyed, and Installation Information provided, in accord with this section must be in a format that is publicly documented (and with an implementation available to the public in source code form), and must require no special password or key for unpacking, reading or copying.

7. Additional Terms.

"Additional permissions" are terms that supplement the terms of this License by making exceptions from one or more of its conditions. Additional permissions that are applicable to the entire Program shall be treated as though they were included in this License, to the extent that they are valid under applicable law. If additional permissions apply only to part of the Program, that part may be used separately under those permissions, but the entire Program remains governed by this License without regard to the additional permissions.

When you convey a copy of a covered work, you may at your option remove any additional permissions from that copy, or from any part of it. (Additional permissions may be written to require their own removal in certain cases when you modify the work.) You may place

additional permissions on material, added by you to a covered work, for which you have or can give appropriate copyright permission.

Notwithstanding any other provision of this License, for material you add to a covered work, you may (if authorized by the copyright holders of that material) supplement the terms of this License with terms:

- a) Disclaiming warranty or limiting liability differently from the terms of sections 15 and 16 of this License; or
- b) Requiring preservation of specified reasonable legal notices or author attributions in that material or in the Appropriate Legal Notices displayed by works containing it; or
- c) Prohibiting misrepresentation of the origin of that material, or requiring that modified versions of such material be marked in reasonable ways as different from the original version; or
- d) Limiting the use for publicity purposes of names of licensors or authors of the material; or
- e) Declining to grant rights under trademark law for use of some trade names, trademarks, or service marks; or
- f) Requiring indemnification of licensors and authors of that material by anyone who conveys the material (or modified versions of it) with contractual assumptions of liability to the recipient, for any liability that these contractual assumptions directly impose on those licensors and authors.

All other non-permissive additional terms are considered "further restrictions" within the meaning of section 10. If the Program as you received it, or any part of it, contains a notice stating that it is governed by this License along with a term that is a further restriction, you may remove that term. If a license document contains a further restriction but permits relicensing or conveying under this License, you may add to a covered work material governed by the terms of that license document, provided that the further restriction does not survive such relicensing or conveying.

If you add terms to a covered work in accord with this section, you must place, in the relevant source files, a statement of the additional terms that apply to those files, or a notice indicating where to find the applicable terms.

Additional terms, permissive or non-permissive, may be stated in the form of a separately written license, or stated as exceptions; the above requirements apply either way.

8. Termination.

You may not propagate or modify a covered work except as expressly provided under this License. Any attempt otherwise to propagate or modify it is void, and will automatically terminate your rights under this License (including any patent licenses granted under the third paragraph of section 11).

However, if you cease all violation of this License, then your license from a particular copyright holder is reinstated (a) provisionally, unless and until the copyright holder explicitly and finally terminates your license, and (b) permanently, if the copyright holder fails to notify you of the violation by some reasonable means prior to 60 days after the cessation.

Moreover, your license from a particular copyright holder is reinstated permanently if the copyright holder notifies you of the violation by some reasonable means, this is the first time you have received notice of violation of this License (for any work) from that copyright holder, and you cure the violation prior to 30 days after your receipt of the notice.

Termination of your rights under this section does not terminate the licenses of parties who have received copies or rights from you under this License. If your rights have been terminated and not permanently reinstated, you do not qualify to receive new licenses for the same material under section 10.

9. Acceptance Not Required for Having Copies.

You are not required to accept this License in order to receive or run a copy of the Program. Ancillary propagation of a covered work occurring solely as a consequence of using peer-to-peer transmission to receive a copy likewise does not require acceptance. However, nothing other than this License grants you permission to propagate or modify any covered work. These actions infringe copyright if you do not accept this License. Therefore, by modifying or propagating a covered work, you indicate your acceptance of this License to do so.

10. Automatic Licensing of Downstream Recipients.

Each time you convey a covered work, the recipient automatically receives a license from the original licensors, to run, modify and propagate that work, subject to this License. You are not responsible for enforcing compliance by third parties with this License.

An "entity transaction" is a transaction transferring control of an organization, or substantially all assets of one, or subdividing an organization, or merging organizations. If propagation of a covered work results from an entity transaction, each party to that transaction who receives a copy of the work also receives whatever licenses to the work the party's predecessor in interest had or could give under the previous paragraph, plus a right to possession of the Corresponding Source of the work from the predecessor in interest, if the predecessor has it or can get it with reasonable efforts.

You may not impose any further restrictions on the exercise of the rights granted or affirmed under this License. For example, you may not impose a license fee, royalty, or other charge for exercise of rights granted under this License, and you may not initiate litigation (including a cross-claim or counterclaim in a lawsuit) alleging that any patent claim is infringed by making, using, selling, offering for sale, or importing the Program or any portion of it.

11. Patents.

A "contributor" is a copyright holder who authorizes use under this License of the Program or a work on which the Program is based. The work thus licensed is called the contributor's "contributor version".

A contributor's "essential patent claims" are all patent claims owned or controlled by the contributor, whether already acquired or hereafter acquired, that would be infringed by some manner, permitted by this License, of making, using, or selling its contributor version, but do not include claims that would be infringed only as a consequence of further modification of the contributor version. For purposes of this definition, "control" includes the right to grant patent sublicenses in a manner consistent with the requirements of this License.

Each contributor grants you a non-exclusive, worldwide, royalty-free patent license under the contributor's essential patent claims, to make, use, sell, offer for sale, import and otherwise run, modify and propagate the contents of its contributor version.

In the following three paragraphs, a "patent license" is any express agreement or commitment, however denominated, not to enforce a patent (such as an express permission to practice a patent or covenant not to sue for patent infringement). To "grant" such a patent license to a party means to make such an agreement or commitment not to enforce a patent against the party.

If you convey a covered work, knowingly relying on a patent license, and the Corresponding Source of the work is not available for anyone to copy, free of charge and under the terms of this License, through a publicly available network server or other readily accessible means, then you must either (1) cause the Corresponding Source to be so available, or (2) arrange to deprive yourself of the benefit of the patent license for this particular work, or (3) arrange, in a manner consistent with the requirements of this License, to extend the patent license to downstream recipients. "Knowingly relying" means you have actual knowledge that, but for the patent license, your conveying the covered work in a country, or your recipient's use of the covered work in a country, would infringe one or more identifiable patents in that country that you have reason to believe are valid.

If, pursuant to or in connection with a single transaction or arrangement, you convey, or propagate by procuring conveyance of, a covered work, and grant a patent license to some of the parties receiving the covered work authorizing them to use, propagate, modify or convey a specific copy of the covered work, then the patent license you grant is automatically extended to all recipients of the covered work and works based on it.

A patent license is "discriminatory" if it does not include within the scope of its coverage, prohibits the exercise of, or is conditioned on the non-exercise of one or more of the rights that are specifically granted under this License. You may not convey a covered work if you are a party to an arrangement with a third party that is in the business of distributing software, under which you make payment to the third party based on the extent of your activity of conveying the work, and under which the third party grants, to any of the parties who would receive the covered work from you, a discriminatory patent license (a) in connection with copies of the covered work conveyed by you (or copies made from those copies), or (b) primarily for and in connection with specific products or compilations that contain the covered work, unless you entered into that arrangement, or that patent license was granted, prior to 28 March 2007.

Nothing in this License shall be construed as excluding or limiting any implied license or other defenses to infringement that may otherwise be available to you under applicable patent law.

12. No Surrender of Others' Freedom.

If conditions are imposed on you (whether by court order, agreement or otherwise) that contradict the conditions of this License, they do not excuse you from the conditions of this License. If you cannot convey a covered work so as to satisfy simultaneously your obligations under this License and any other pertinent obligations, then as a consequence you may not convey it at all. For example, if you agree to terms that obligate you to collect a royalty for further conveying from those to whom you convey the Program, the only way you could satisfy both those terms and this License would be to refrain entirely from conveying the Program.

13. Use with the GNU Affero General Public License.

Notwithstanding any other provision of this License, you have permission to link or combine any covered work with a work licensed under version 3 of the GNU Affero General Public License into a single combined work, and to convey the resulting work. The terms of this License will continue to apply to the part which is the covered work, but the special requirements of the GNU Affero General Public License, section 13, concerning interaction through a network will apply to the combination as such.

14. Revised Versions of this License.

The Free Software Foundation may publish revised and/or new versions of the GNU General Public License from time to time. Such new versions will be similar in spirit to the present version, but may differ in detail to

address new problems or concerns.

Each version is given a distinguishing version number. If the Program specifies that a certain numbered version of the GNU General Public License "or any later version" applies to it, you have the option of following the terms and conditions either of that numbered version or of any later version published by the Free Software Foundation. If the Program does not specify a version number of the GNU General Public License, you may choose any version ever published by the Free Software Foundation.

If the Program specifies that a proxy can decide which future versions of the GNU General Public License can be used, that proxy's public statement of acceptance of a version permanently authorizes you to choose that version for the Program.

Later license versions may give you additional or different permissions. However, no additional obligations are imposed on any author or copyright holder as a result of your choosing to follow a later version.

15. Disclaimer of Warranty.

THERE IS NO WARRANTY FOR THE PROGRAM, TO THE EXTENT PERMITTED BY APPLICABLE LAW. EXCEPT WHEN OTHERWISE STATED IN WRITING THE COPYRIGHT HOLDERS AND/OR OTHER PARTIES PROVIDE THE PROGRAM "AS IS" WITHOUT WARRANTY OF ANY KIND, EITHER EXPRESSED OR IMPLIED, INCLUDING, BUT NOT LIMITED TO, THE IMPLIED WARRANTIES OF MERCHANTABILITY AND FITNESS FOR A PARTICULAR PURPOSE. THE ENTIRE RISK AS TO THE QUALITY AND PERFORMANCE OF THE PROGRAM IS WITH YOU. SHOULD THE PROGRAM PROVE DEFECTIVE, YOU ASSUME THE COST OF ALL NECESSARY SERVICING, REPAIR OR CORRECTION.

16. Limitation of Liability.

IN NO EVENT UNLESS REQUIRED BY APPLICABLE LAW OR AGREED TO IN WRITING WILL ANY COPYRIGHT HOLDER, OR ANY OTHER PARTY WHO MODIFIES AND/OR CONVEYS THE PROGRAM AS PERMITTED ABOVE, BE LIABLE TO YOU FOR DAMAGES, INCLUDING ANY GENERAL, SPECIAL, INCIDENTAL OR CONSEQUENTIAL DAMAGES ARISING OUT OF THE USE OR INABILITY TO USE THE PROGRAM (INCLUDING BUT NOT LIMITED TO LOSS OF DATA OR DATA BEING RENDERED INACCURATE OR LOSSES SUSTAINED BY YOU OR THIRD PARTIES OR A FAILURE OF THE PROGRAM TO OPERATE WITH ANY OTHER PROGRAMS), EVEN IF SUCH HOLDER OR OTHER PARTY HAS BEEN ADVISED OF THE POSSIBILITY OF SUCH DAMAGES.

17. Interpretation of Sections 15 and 16.

If the disclaimer of warranty and limitation of liability provided above cannot be given local legal effect according to their terms, reviewing courts shall apply local law that most closely approximates an absolute waiver of all civil liability in connection with the Program, unless a warranty or assumption of liability accompanies a copy of the Program in return for a fee.

END OF TERMS AND CONDITIONS

How to Apply These Terms to Your New Programs

If you develop a new program, and you want it to be of the greatest possible use to the public, the best way to achieve this is to make it free software which everyone can redistribute and change under these terms.

To do so, attach the following notices to the program. It is safest to attach them to the start of each source file to most effectively state the exclusion of warranty; and each file should have at least the "copyright" line and a pointer to where the full notice is found.

```
<one line to give the program's name and a brief idea of what it does.>  
Copyright (C) <year> <name of author>
```

This program is free software: you can redistribute it and/or modify

it under the terms of the GNU General Public License as published by the Free Software Foundation, either version 3 of the License, or (at your option) any later version.

This program is distributed in the hope that it will be useful, but WITHOUT ANY WARRANTY; without even the implied warranty of MERCHANTABILITY or FITNESS FOR A PARTICULAR PURPOSE. See the GNU General Public License for more details.

You should have received a copy of the GNU General Public License along with this program. If not, see <<https://www.gnu.org/licenses/>>.

Also add information on how to contact you by electronic and paper mail.

If the program does terminal interaction, make it output a short notice like this when it starts in an interactive mode:

```
<program> Copyright (C) <year> <name of author>
This program comes with ABSOLUTELY NO WARRANTY; for details type `show w'.
This is free software, and you are welcome to redistribute it
under certain conditions; type `show c' for details.
```

The hypothetical commands `show w' and `show c' should show the appropriate parts of the General Public License. Of course, your program's commands might be different; for a GUI interface, you would use an "about box".

You should also get your employer (if you work as a programmer) or school, if any, to sign a "copyright disclaimer" for the program, if necessary. For more information on this, and how to apply and follow the GNU GPL, see <<https://www.gnu.org/licenses/>>.

The GNU General Public License does not permit incorporating your program into proprietary programs. If your program is a subroutine library, you may consider it more useful to permit linking proprietary applications with the library. If this is what you want to do, use the GNU Lesser General Public License instead of this License. But first, please read <<https://www.gnu.org/licenses/why-not-lgpl.html>>.

LGPL-2.1

GNU LESSER GENERAL PUBLIC LICENSE Version 2.1, February 1999

Copyright (C) 1991, 1999 Free Software Foundation, Inc.
51 Franklin Street, Fifth Floor, Boston, MA 02110-1301 USA
Everyone is permitted to copy and distribute verbatim copies
of this license document, but changing it is not allowed.

[This is the first released version of the Lesser GPL. It also counts as the successor of the GNU Library Public License, version 2, hence the version number 2.1.]

Preamble

The licenses for most software are designed to take away your freedom to share and change it. By contrast, the GNU General Public Licenses are intended to guarantee your freedom to share and change free software--to make sure the software is free for all its users.

This license, the Lesser General Public License, applies to some specially designated software packages--typically libraries--of the Free Software Foundation and other authors who decide to use it. You can use it too, but we suggest you first think carefully about whether this license or the ordinary General Public License is the better strategy to use in any particular case, based on the explanations below.

When we speak of free software, we are referring to freedom of use, not price. Our General Public Licenses are designed to make sure that you have the freedom to distribute copies of free software (and charge

for this service if you wish); that you receive source code or can get it if you want it; that you can change the software and use pieces of it in new free programs; and that you are informed that you can do these things.

To protect your rights, we need to make restrictions that forbid distributors to deny you these rights or to ask you to surrender these rights. These restrictions translate to certain responsibilities for you if you distribute copies of the library or if you modify it.

For example, if you distribute copies of the library, whether gratis or for a fee, you must give the recipients all the rights that we gave you. You must make sure that they, too, receive or can get the source code. If you link other code with the library, you must provide complete object files to the recipients, so that they can relink them with the library after making changes to the library and recompiling it. And you must show them these terms so they know their rights.

We protect your rights with a two-step method: (1) we copyright the library, and (2) we offer you this license, which gives you legal permission to copy, distribute and/or modify the library.

To protect each distributor, we want to make it very clear that there is no warranty for the free library. Also, if the library is modified by someone else and passed on, the recipients should know that what they have is not the original version, so that the original author's reputation will not be affected by problems that might be introduced by others.

Finally, software patents pose a constant threat to the existence of any free program. We wish to make sure that a company cannot effectively restrict the users of a free program by obtaining a restrictive license from a patent holder. Therefore, we insist that any patent license obtained for a version of the library must be consistent with the full freedom of use specified in this license.

Most GNU software, including some libraries, is covered by the ordinary GNU General Public License. This license, the GNU Lesser General Public License, applies to certain designated libraries, and is quite different from the ordinary General Public License. We use this license for certain libraries in order to permit linking those libraries into non-free programs.

When a program is linked with a library, whether statically or using a shared library, the combination of the two is legally speaking a combined work, a derivative of the original library. The ordinary General Public License therefore permits such linking only if the entire combination fits its criteria of freedom. The Lesser General Public License permits more lax criteria for linking other code with the library.

We call this license the "Lesser" General Public License because it does less to protect the user's freedom than the ordinary General Public License. It also provides other free software developers less of an advantage over competing non-free programs. These disadvantages are the reason we use the ordinary General Public License for many libraries. However, the Lesser license provides advantages in certain special circumstances.

For example, on rare occasions, there may be a special need to encourage the widest possible use of a certain library, so that it becomes a de-facto standard. To achieve this, non-free programs must be allowed to use the library. A more frequent case is that a free library does the same job as widely used non-free libraries. In this case, there is little to gain by limiting the free library to free software only, so we use the Lesser General Public License.

In other cases, permission to use a particular library in non-free programs enables a greater number of people to use a large body of free software. For example, permission to use the GNU C Library in

non-free programs enables many more people to use the whole GNU operating system, as well as its variant, the GNU/Linux operating system.

Although the Lesser General Public License is less protective of the users' freedom, it does ensure that the user of a program that is linked with the Library has the freedom and the wherewithal to run that program using a modified version of the Library.

The precise terms and conditions for copying, distribution and modification follow. Pay close attention to the difference between a "work based on the library" and a "work that uses the library". The former contains code derived from the library, whereas the latter must be combined with the library in order to run.

GNU LESSER GENERAL PUBLIC LICENSE
TERMS AND CONDITIONS FOR COPYING, DISTRIBUTION AND MODIFICATION

0. This License Agreement applies to any software library or other program which contains a notice placed by the copyright holder or other authorized party saying it may be distributed under the terms of this Lesser General Public License (also called "this License"). Each licensee is addressed as "you".

A "library" means a collection of software functions and/or data prepared so as to be conveniently linked with application programs (which use some of those functions and data) to form executables.

The "Library", below, refers to any such software library or work which has been distributed under these terms. A "work based on the Library" means either the Library or any derivative work under copyright law: that is to say, a work containing the Library or a portion of it, either verbatim or with modifications and/or translated straightforwardly into another language. (Hereinafter, translation is included without limitation in the term "modification".)

"Source code" for a work means the preferred form of the work for making modifications to it. For a library, complete source code means all the source code for all modules it contains, plus any associated interface definition files, plus the scripts used to control compilation and installation of the library.

Activities other than copying, distribution and modification are not covered by this License; they are outside its scope. The act of running a program using the Library is not restricted, and output from such a program is covered only if its contents constitute a work based on the Library (independent of the use of the Library in a tool for writing it). Whether that is true depends on what the Library does and what the program that uses the Library does.

1. You may copy and distribute verbatim copies of the Library's complete source code as you receive it, in any medium, provided that you conspicuously and appropriately publish on each copy an appropriate copyright notice and disclaimer of warranty; keep intact all the notices that refer to this License and to the absence of any warranty; and distribute a copy of this License along with the Library.

You may charge a fee for the physical act of transferring a copy, and you may at your option offer warranty protection in exchange for a fee.

2. You may modify your copy or copies of the Library or any portion of it, thus forming a work based on the Library, and copy and distribute such modifications or work under the terms of Section 1 above, provided that you also meet all of these conditions:

- a) The modified work must itself be a software library.
- b) You must cause the files modified to carry prominent notices

stating that you changed the files and the date of any change.

c) You must cause the whole of the work to be licensed at no charge to all third parties under the terms of this License.

d) If a facility in the modified Library refers to a function or a table of data to be supplied by an application program that uses the facility, other than as an argument passed when the facility is invoked, then you must make a good faith effort to ensure that, in the event an application does not supply such function or table, the facility still operates, and performs whatever part of its purpose remains meaningful.

(For example, a function in a library to compute square roots has a purpose that is entirely well-defined independent of the application. Therefore, Subsection 2d requires that any application-supplied function or table used by this function must be optional: if the application does not supply it, the square root function must still compute square roots.)

These requirements apply to the modified work as a whole. If identifiable sections of that work are not derived from the Library, and can be reasonably considered independent and separate works in themselves, then this License, and its terms, do not apply to those sections when you distribute them as separate works. But when you distribute the same sections as part of a whole which is a work based on the Library, the distribution of the whole must be on the terms of this License, whose permissions for other licensees extend to the entire whole, and thus to each and every part regardless of who wrote it.

Thus, it is not the intent of this section to claim rights or contest your rights to work written entirely by you; rather, the intent is to exercise the right to control the distribution of derivative or collective works based on the Library.

In addition, mere aggregation of another work not based on the Library with the Library (or with a work based on the Library) on a volume of a storage or distribution medium does not bring the other work under the scope of this License.

3. You may opt to apply the terms of the ordinary GNU General Public License instead of this License to a given copy of the Library. To do this, you must alter all the notices that refer to this License, so that they refer to the ordinary GNU General Public License, version 2, instead of to this License. (If a newer version than version 2 of the ordinary GNU General Public License has appeared, then you can specify that version instead if you wish.) Do not make any other change in these notices.

Once this change is made in a given copy, it is irreversible for that copy, so the ordinary GNU General Public License applies to all subsequent copies and derivative works made from that copy.

This option is useful when you wish to copy part of the code of the Library into a program that is not a library.

4. You may copy and distribute the Library (or a portion or derivative of it, under Section 2) in object code or executable form under the terms of Sections 1 and 2 above provided that you accompany it with the complete corresponding machine-readable source code, which must be distributed under the terms of Sections 1 and 2 above on a medium customarily used for software interchange.

If distribution of object code is made by offering access to copy from a designated place, then offering equivalent access to copy the source code from the same place satisfies the requirement to distribute the source code, even though third parties are not compelled to copy the source along with the object code.

5. A program that contains no derivative of any portion of the Library, but is designed to work with the Library by being compiled or linked with it, is called a "work that uses the Library". Such a work, in isolation, is not a derivative work of the Library, and therefore falls outside the scope of this License.

However, linking a "work that uses the Library" with the Library creates an executable that is a derivative of the Library (because it contains portions of the Library), rather than a "work that uses the library". The executable is therefore covered by this License. Section 6 states terms for distribution of such executables.

When a "work that uses the Library" uses material from a header file that is part of the Library, the object code for the work may be a derivative work of the Library even though the source code is not. Whether this is true is especially significant if the work can be linked without the Library, or if the work is itself a library. The threshold for this to be true is not precisely defined by law.

If such an object file uses only numerical parameters, data structure layouts and accessors, and small macros and small inline functions (ten lines or less in length), then the use of the object file is unrestricted, regardless of whether it is legally a derivative work. (Executables containing this object code plus portions of the Library will still fall under Section 6.)

Otherwise, if the work is a derivative of the Library, you may distribute the object code for the work under the terms of Section 6. Any executables containing that work also fall under Section 6, whether or not they are linked directly with the Library itself.

6. As an exception to the Sections above, you may also combine or link a "work that uses the Library" with the Library to produce a work containing portions of the Library, and distribute that work under terms of your choice, provided that the terms permit modification of the work for the customer's own use and reverse engineering for debugging such modifications.

You must give prominent notice with each copy of the work that the Library is used in it and that the Library and its use are covered by this License. You must supply a copy of this License. If the work during execution displays copyright notices, you must include the copyright notice for the Library among them, as well as a reference directing the user to the copy of this License. Also, you must do one of these things:

- a) Accompany the work with the complete corresponding machine-readable source code for the Library including whatever changes were used in the work (which must be distributed under Sections 1 and 2 above); and, if the work is an executable linked with the Library, with the complete machine-readable "work that uses the Library", as object code and/or source code, so that the user can modify the Library and then relink to produce a modified executable containing the modified Library. (It is understood that the user who changes the contents of definitions files in the Library will not necessarily be able to recompile the application to use the modified definitions.)
- b) Use a suitable shared library mechanism for linking with the Library. A suitable mechanism is one that (1) uses at run time a copy of the library already present on the user's computer system, rather than copying library functions into the executable, and (2) will operate properly with a modified version of the library, if the user installs one, as long as the modified version is interface-compatible with the version that the work was made with.
- c) Accompany the work with a written offer, valid for at least three years, to give the same user the materials specified in Subsection 6a, above, for a charge no more than the cost of performing this distribution.

d) If distribution of the work is made by offering access to copy from a designated place, offer equivalent access to copy the above specified materials from the same place.

e) Verify that the user has already received a copy of these materials or that you have already sent this user a copy.

For an executable, the required form of the "work that uses the Library" must include any data and utility programs needed for reproducing the executable from it. However, as a special exception, the materials to be distributed need not include anything that is normally distributed (in either source or binary form) with the major components (compiler, kernel, and so on) of the operating system on which the executable runs, unless that component itself accompanies the executable.

It may happen that this requirement contradicts the license restrictions of other proprietary libraries that do not normally accompany the operating system. Such a contradiction means you cannot use both them and the Library together in an executable that you distribute.

7. You may place library facilities that are a work based on the Library side-by-side in a single library together with other library facilities not covered by this License, and distribute such a combined library, provided that the separate distribution of the work based on the Library and of the other library facilities is otherwise permitted, and provided that you do these two things:

a) Accompany the combined library with a copy of the same work based on the Library, uncombined with any other library facilities. This must be distributed under the terms of the Sections above.

b) Give prominent notice with the combined library of the fact that part of it is a work based on the Library, and explaining where to find the accompanying uncombined form of the same work.

8. You may not copy, modify, sublicense, link with, or distribute the Library except as expressly provided under this License. Any attempt otherwise to copy, modify, sublicense, link with, or distribute the Library is void, and will automatically terminate your rights under this License. However, parties who have received copies, or rights, from you under this License will not have their licenses terminated so long as such parties remain in full compliance.

9. You are not required to accept this License, since you have not signed it. However, nothing else grants you permission to modify or distribute the Library or its derivative works. These actions are prohibited by law if you do not accept this License. Therefore, by modifying or distributing the Library (or any work based on the Library), you indicate your acceptance of this License to do so, and all its terms and conditions for copying, distributing or modifying the Library or works based on it.

10. Each time you redistribute the Library (or any work based on the Library), the recipient automatically receives a license from the original licensor to copy, distribute, link with or modify the Library subject to these terms and conditions. You may not impose any further restrictions on the recipients' exercise of the rights granted herein. You are not responsible for enforcing compliance by third parties with this License.

11. If, as a consequence of a court judgment or allegation of patent infringement or for any other reason (not limited to patent issues), conditions are imposed on you (whether by court order, agreement or otherwise) that contradict the conditions of this License, they do not excuse you from the conditions of this License. If you cannot distribute so as to satisfy simultaneously your obligations under this

License and any other pertinent obligations, then as a consequence you may not distribute the Library at all. For example, if a patent license would not permit royalty-free redistribution of the Library by all those who receive copies directly or indirectly through you, then the only way you could satisfy both it and this License would be to refrain entirely from distribution of the Library.

If any portion of this section is held invalid or unenforceable under any particular circumstance, the balance of the section is intended to apply, and the section as a whole is intended to apply in other circumstances.

It is not the purpose of this section to induce you to infringe any patents or other property right claims or to contest validity of any such claims; this section has the sole purpose of protecting the integrity of the free software distribution system which is implemented by public license practices. Many people have made generous contributions to the wide range of software distributed through that system in reliance on consistent application of that system; it is up to the author/donor to decide if he or she is willing to distribute software through any other system and a licensee cannot impose that choice.

This section is intended to make thoroughly clear what is believed to be a consequence of the rest of this License.

12. If the distribution and/or use of the Library is restricted in certain countries either by patents or by copyrighted interfaces, the original copyright holder who places the Library under this License may add an explicit geographical distribution limitation excluding those countries, so that distribution is permitted only in or among countries not thus excluded. In such case, this License incorporates the limitation as if written in the body of this License.

13. The Free Software Foundation may publish revised and/or new versions of the Lesser General Public License from time to time. Such new versions will be similar in spirit to the present version, but may differ in detail to address new problems or concerns.

Each version is given a distinguishing version number. If the Library specifies a version number of this License which applies to it and "any later version", you have the option of following the terms and conditions either of that version or of any later version published by the Free Software Foundation. If the Library does not specify a license version number, you may choose any version ever published by the Free Software Foundation.

14. If you wish to incorporate parts of the Library into other free programs whose distribution conditions are incompatible with these, write to the author to ask for permission. For software which is copyrighted by the Free Software Foundation, write to the Free Software Foundation; we sometimes make exceptions for this. Our decision will be guided by the two goals of preserving the free status of all derivatives of our free software and of promoting the sharing and reuse of software generally.

NO WARRANTY

15. BECAUSE THE LIBRARY IS LICENSED FREE OF CHARGE, THERE IS NO WARRANTY FOR THE LIBRARY, TO THE EXTENT PERMITTED BY APPLICABLE LAW. EXCEPT WHEN OTHERWISE STATED IN WRITING THE COPYRIGHT HOLDERS AND/OR OTHER PARTIES PROVIDE THE LIBRARY "AS IS" WITHOUT WARRANTY OF ANY KIND, EITHER EXPRESSED OR IMPLIED, INCLUDING, BUT NOT LIMITED TO, THE IMPLIED WARRANTIES OF MERCHANTABILITY AND FITNESS FOR A PARTICULAR PURPOSE. THE ENTIRE RISK AS TO THE QUALITY AND PERFORMANCE OF THE LIBRARY IS WITH YOU. SHOULD THE LIBRARY PROVE DEFECTIVE, YOU ASSUME THE COST OF ALL NECESSARY SERVICING, REPAIR OR CORRECTION.

16. IN NO EVENT UNLESS REQUIRED BY APPLICABLE LAW OR AGREED TO IN WRITING WILL ANY COPYRIGHT HOLDER, OR ANY OTHER PARTY WHO MAY MODIFY AND/OR REDISTRIBUTE THE LIBRARY AS PERMITTED ABOVE, BE LIABLE TO YOU

FOR DAMAGES, INCLUDING ANY GENERAL, SPECIAL, INCIDENTAL OR CONSEQUENTIAL DAMAGES ARISING OUT OF THE USE OR INABILITY TO USE THE LIBRARY (INCLUDING BUT NOT LIMITED TO LOSS OF DATA OR DATA BEING RENDERED INACCURATE OR LOSSES SUSTAINED BY YOU OR THIRD PARTIES OR A FAILURE OF THE LIBRARY TO OPERATE WITH ANY OTHER SOFTWARE), EVEN IF SUCH HOLDER OR OTHER PARTY HAS BEEN ADVISED OF THE POSSIBILITY OF SUCH DAMAGES.

END OF TERMS AND CONDITIONS

How to Apply These Terms to Your New Libraries

If you develop a new library, and you want it to be of the greatest possible use to the public, we recommend making it free software that everyone can redistribute and change. You can do so by permitting redistribution under these terms (or, alternatively, under the terms of the ordinary General Public License).

To apply these terms, attach the following notices to the library. It is safest to attach them to the start of each source file to most effectively convey the exclusion of warranty; and each file should have at least the "copyright" line and a pointer to where the full notice is found.

```
<one line to give the library's name and a brief idea of what it does.>
Copyright (C) <year> <name of author>
```

```
This library is free software; you can redistribute it and/or
modify it under the terms of the GNU Lesser General Public
License as published by the Free Software Foundation; either
version 2.1 of the License, or (at your option) any later version.
```

```
This library is distributed in the hope that it will be useful,
but WITHOUT ANY WARRANTY; without even the implied warranty of
MERCHANTABILITY or FITNESS FOR A PARTICULAR PURPOSE. See the GNU
Lesser General Public License for more details.
```

```
You should have received a copy of the GNU Lesser General Public
License along with this library; if not, write to the Free Software
Foundation, Inc., 51 Franklin Street, Fifth Floor, Boston, MA 02110-1301 USA
```

Also add information on how to contact you by electronic and paper mail.

You should also get your employer (if you work as a programmer) or your school, if any, to sign a "copyright disclaimer" for the library, if necessary. Here is a sample; alter the names:

```
Yoyodyne, Inc., hereby disclaims all copyright interest in the
library `Frob' (a library for tweaking knobs) written by James Random Hacker.
```

```
<signature of Ty Coon>, 1 April 1990
Ty Coon, President of Vice
```

That's all there is to it!

MPL-2.0

```
Mozilla Public License Version 2.0
=====
```

1. Definitions

1.1. "Contributor"

means each individual or legal entity that creates, contributes to the creation of, or owns Covered Software.

1.2. "Contributor Version"

means the combination of the Contributions of others (if any) used by a Contributor and that particular Contributor's Contribution.

- 1.3. "Contribution"
means Covered Software of a particular Contributor.
- 1.4. "Covered Software"
means Source Code Form to which the initial Contributor has attached the notice in Exhibit A, the Executable Form of such Source Code Form, and Modifications of such Source Code Form, in each case including portions thereof.
- 1.5. "Incompatible With Secondary Licenses"
means
- (a) that the initial Contributor has attached the notice described in Exhibit B to the Covered Software; or
 - (b) that the Covered Software was made available under the terms of version 1.1 or earlier of the License, but not also under the terms of a Secondary License.
- 1.6. "Executable Form"
means any form of the work other than Source Code Form.
- 1.7. "Larger Work"
means a work that combines Covered Software with other material, in a separate file or files, that is not Covered Software.
- 1.8. "License"
means this document.
- 1.9. "Licensable"
means having the right to grant, to the maximum extent possible, whether at the time of the initial grant or subsequently, any and all of the rights conveyed by this License.
- 1.10. "Modifications"
means any of the following:
- (a) any file in Source Code Form that results from an addition to, deletion from, or modification of the contents of Covered Software; or
 - (b) any new file in Source Code Form that contains any Covered Software.
- 1.11. "Patent Claims" of a Contributor
means any patent claim(s), including without limitation, method, process, and apparatus claims, in any patent Licensable by such Contributor that would be infringed, but for the grant of the License, by the making, using, selling, offering for sale, having made, import, or transfer of either its Contributions or its Contributor Version.
- 1.12. "Secondary License"
means either the GNU General Public License, Version 2.0, the GNU Lesser General Public License, Version 2.1, the GNU Affero General Public License, Version 3.0, or any later versions of those licenses.
- 1.13. "Source Code Form"
means the form of the work preferred for making modifications.
- 1.14. "You" (or "Your")
means an individual or a legal entity exercising rights under this License. For legal entities, "You" includes any entity that controls, is controlled by, or is under common control with You. For purposes of this definition, "control" means (a) the power, direct or indirect, to cause the direction or management of such entity, whether by contract or otherwise, or (b) ownership of more than fifty percent (50%) of the outstanding shares or beneficial

ownership of such entity.

2. License Grants and Conditions

2.1. Grants

Each Contributor hereby grants You a world-wide, royalty-free, non-exclusive license:

- (a) under intellectual property rights (other than patent or trademark) Licensable by such Contributor to use, reproduce, make available, modify, display, perform, distribute, and otherwise exploit its Contributions, either on an unmodified basis, with Modifications, or as part of a Larger Work; and
- (b) under Patent Claims of such Contributor to make, use, sell, offer for sale, have made, import, and otherwise transfer either its Contributions or its Contributor Version.

2.2. Effective Date

The licenses granted in Section 2.1 with respect to any Contribution become effective for each Contribution on the date the Contributor first distributes such Contribution.

2.3. Limitations on Grant Scope

The licenses granted in this Section 2 are the only rights granted under this License. No additional rights or licenses will be implied from the distribution or licensing of Covered Software under this License. Notwithstanding Section 2.1(b) above, no patent license is granted by a Contributor:

- (a) for any code that a Contributor has removed from Covered Software; or
- (b) for infringements caused by: (i) Your and any other third party's modifications of Covered Software, or (ii) the combination of its Contributions with other software (except as part of its Contributor Version); or
- (c) under Patent Claims infringed by Covered Software in the absence of its Contributions.

This License does not grant any rights in the trademarks, service marks, or logos of any Contributor (except as may be necessary to comply with the notice requirements in Section 3.4).

2.4. Subsequent Licenses

No Contributor makes additional grants as a result of Your choice to distribute the Covered Software under a subsequent version of this License (see Section 10.2) or under the terms of a Secondary License (if permitted under the terms of Section 3.3).

2.5. Representation

Each Contributor represents that the Contributor believes its Contributions are its original creation(s) or it has sufficient rights to grant the rights to its Contributions conveyed by this License.

2.6. Fair Use

This License is not intended to limit any rights You have under applicable copyright doctrines of fair use, fair dealing, or other equivalents.

2.7. Conditions

Sections 3.1, 3.2, 3.3, and 3.4 are conditions of the licenses granted in Section 2.1.

3. Responsibilities

3.1. Distribution of Source Form

All distribution of Covered Software in Source Code Form, including any Modifications that You create or to which You contribute, must be under the terms of this License. You must inform recipients that the Source Code Form of the Covered Software is governed by the terms of this License, and how they can obtain a copy of this License. You may not attempt to alter or restrict the recipients' rights in the Source Code Form.

3.2. Distribution of Executable Form

If You distribute Covered Software in Executable Form then:

- (a) such Covered Software must also be made available in Source Code Form, as described in Section 3.1, and You must inform recipients of the Executable Form how they can obtain a copy of such Source Code Form by reasonable means in a timely manner, at a charge no more than the cost of distribution to the recipient; and
- (b) You may distribute such Executable Form under the terms of this License, or sublicense it under different terms, provided that the license for the Executable Form does not attempt to limit or alter the recipients' rights in the Source Code Form under this License.

3.3. Distribution of a Larger Work

You may create and distribute a Larger Work under terms of Your choice, provided that You also comply with the requirements of this License for the Covered Software. If the Larger Work is a combination of Covered Software with a work governed by one or more Secondary Licenses, and the Covered Software is not Incompatible With Secondary Licenses, this License permits You to additionally distribute such Covered Software under the terms of such Secondary License(s), so that the recipient of the Larger Work may, at their option, further distribute the Covered Software under the terms of either this License or such Secondary License(s).

3.4. Notices

You may not remove or alter the substance of any license notices (including copyright notices, patent notices, disclaimers of warranty, or limitations of liability) contained within the Source Code Form of the Covered Software, except that You may alter any license notices to the extent required to remedy known factual inaccuracies.

3.5. Application of Additional Terms

You may choose to offer, and to charge a fee for, warranty, support, indemnity or liability obligations to one or more recipients of Covered Software. However, You may do so only on Your own behalf, and not on behalf of any Contributor. You must make it absolutely clear that any such warranty, support, indemnity, or liability obligation is offered by You alone, and You hereby agree to indemnify every Contributor for any liability incurred by such Contributor as a result of warranty, support, indemnity or liability terms You offer. You may include additional disclaimers of warranty and limitations of liability specific to any jurisdiction.

4. Inability to Comply Due to Statute or Regulation

If it is impossible for You to comply with any of the terms of this License with respect to some or all of the Covered Software due to

statute, judicial order, or regulation then You must: (a) comply with the terms of this License to the maximum extent possible; and (b) describe the limitations and the code they affect. Such description must be placed in a text file included with all distributions of the Covered Software under this License. Except to the extent prohibited by statute or regulation, such description must be sufficiently detailed for a recipient of ordinary skill to be able to understand it.

5. Termination

5.1. The rights granted under this License will terminate automatically if You fail to comply with any of its terms. However, if You become compliant, then the rights granted under this License from a particular Contributor are reinstated (a) provisionally, unless and until such Contributor explicitly and finally terminates Your grants, and (b) on an ongoing basis, if such Contributor fails to notify You of the non-compliance by some reasonable means prior to 60 days after You have come back into compliance. Moreover, Your grants from a particular Contributor are reinstated on an ongoing basis if such Contributor notifies You of the non-compliance by some reasonable means, this is the first time You have received notice of non-compliance with this License from such Contributor, and You become compliant prior to 30 days after Your receipt of the notice.

5.2. If You initiate litigation against any entity by asserting a patent infringement claim (excluding declaratory judgment actions, counter-claims, and cross-claims) alleging that a Contributor Version directly or indirectly infringes any patent, then the rights granted to You by any and all Contributors for the Covered Software under Section 2.1 of this License shall terminate.

5.3. In the event of termination under Sections 5.1 or 5.2 above, all end user license agreements (excluding distributors and resellers) which have been validly granted by You or Your distributors under this License prior to termination shall survive termination.

```
*****
*
* 6. Disclaimer of Warranty
* -----
*
* Covered Software is provided under this License on an "as is"
* basis, without warranty of any kind, either expressed, implied, or
* statutory, including, without limitation, warranties that the
* Covered Software is free of defects, merchantable, fit for a
* particular purpose or non-infringing. The entire risk as to the
* quality and performance of the Covered Software is with You.
* Should any Covered Software prove defective in any respect, You
* (not any Contributor) assume the cost of any necessary servicing,
* repair, or correction. This disclaimer of warranty constitutes an
* essential part of this License. No use of any Covered Software is
* authorized under this License except under this disclaimer.
*
*****
```

```
*****
*
* 7. Limitation of Liability
* -----
*
* Under no circumstances and under no legal theory, whether tort
* (including negligence), contract, or otherwise, shall any
* Contributor, or anyone who distributes Covered Software as
* permitted above, be liable to You for any direct, indirect,
* special, incidental, or consequential damages of any character
* including, without limitation, damages for lost profits, loss of
* goodwill, work stoppage, computer failure or malfunction, or any
* and all other commercial damages or losses, even if such party
* shall have been informed of the possibility of such damages. This
*
```



```

* limitation of liability shall not apply to liability for death or *
* personal injury resulting from such party's negligence to the *
* extent applicable law prohibits such limitation. Some *
* jurisdictions do not allow the exclusion or limitation of *
* incidental or consequential damages, so this exclusion and *
* limitation may not apply to You. *
* *
*****

```

8. Litigation

Any litigation relating to this License may be brought only in the courts of a jurisdiction where the defendant maintains its principal place of business and such litigation shall be governed by laws of that jurisdiction, without reference to its conflict-of-law provisions. Nothing in this Section shall prevent a party's ability to bring cross-claims or counter-claims.

9. Miscellaneous

This License represents the complete agreement concerning the subject matter hereof. If any provision of this License is held to be unenforceable, such provision shall be reformed only to the extent necessary to make it enforceable. Any law or regulation which provides that the language of a contract shall be construed against the drafter shall not be used to construe this License against a Contributor.

10. Versions of the License

10.1. New Versions

Mozilla Foundation is the license steward. Except as provided in Section 10.3, no one other than the license steward has the right to modify or publish new versions of this License. Each version will be given a distinguishing version number.

10.2. Effect of New Versions

You may distribute the Covered Software under the terms of the version of the License under which You originally received the Covered Software, or under the terms of any subsequent version published by the license steward.

10.3. Modified Versions

If you create software not governed by this License, and you want to create a new license for such software, you may create and use a modified version of this License if you rename the license and remove any references to the name of the license steward (except to note that such modified license differs from this License).

10.4. Distributing Source Code Form that is Incompatible With Secondary Licenses

If You choose to distribute Source Code Form that is Incompatible With Secondary Licenses under the terms of this version of the License, the notice described in Exhibit B of this License must be attached.

Exhibit A - Source Code Form License Notice

This Source Code Form is subject to the terms of the Mozilla Public License, v. 2.0. If a copy of the MPL was not distributed with this file, You can obtain one at <http://mozilla.org/MPL/2.0/>.

If it is not possible or desirable to put the notice in a particular file, then You may include the notice in a location (such as a LICENSE

file in a relevant directory) where a recipient would be likely to look for such a notice.

You may add additional accurate notices of copyright ownership.

Exhibit B - "Incompatible With Secondary Licenses" Notice

This Source Code Form is "Incompatible With Secondary Licenses", as defined by the Mozilla Public License, v. 2.0.

Zlib

This software is provided 'as-is', without any express or implied warranty. In no event will the authors be held liable for any damages arising from the use of this software.

Permission is granted to anyone to use this software for any purpose, including commercial applications, and to alter it and redistribute it freely, subject to the following restrictions:

1. The origin of this software must not be misrepresented; you must not claim that you wrote the original software. If you use this software in a product, an acknowledgment in the product documentation would be appreciated but is not required.
2. Altered source versions must be plainly marked as such, and must not be misrepresented as being the original software.
3. This notice may not be removed or altered from any source distribution.